



TAOGLAS®



Datasheet

Apex White Hinged TG.30

Part No:
TG.30.8113W

Features:

- 600-6000MHz
- Covers 5G/4G Bands
- Typical 50%+ Efficiency and 3dBi+ Peak Gain
- Dipole Swivel Terminal Antenna
- Hinged 90° termination with SMA(M) Connector
- RoHS and REACH Compliant

1.	Introduction	2
2.	Specification	3
3.	Antenna Characteristics	6
4.	Radiation Patterns	8
5.	Mechanical Drawing	76
6.	Packaging	77
<hr/>		
	Changelog	78

Taoglas makes no warranties based on the accuracy or completeness of the contents of this document and reserves the right to make changes to specifications and product descriptions at any time without notice. Taoglas reserves all rights to this document and the information contained herein. Reproduction, use or disclosure to third parties without express permission is strictly prohibited.



1. Introduction



The hinged Apex TG.30 is a Wideband Dipole 5G/4G Antenna – is primarily designed for use with 5G/4G modules, routers and devices that require the highest possible efficiency and peak gain to deliver best in class throughput on all major cellular bands worldwide between 600MHz and 6GHz.

The antenna is a Ground plane independent antenna with a SMA (M) connector and swivel mechanism that allows the antenna part to be rotated. The Apex exhibits high efficiency across the wide spectrum and is backward compatible with 2G and 3G cellular applications such as NB-IoT, Cat-M, LTE, UMTS, Wi-Fi and even has GROUND PLANES included for Assisted GROUND PLANES and/or E911 applications.

Typical Applications include:

- Routers and Gateways
- Access Points
- Remote Monitoring

With very high efficiency on every cellular band globally it is an ideal solution for any device requiring high, reliable performance. It is also guaranteed to meet any type approval or carrier certification requirements from a RF standpoint. It is an omni-directional antenna and the radiation patterns display this and are stable across all bands.

It has a quality robust UV resistant housing for use with wireless terminals. The swivel and hinge mechanism allows the antenna part itself to be orientated in different directions and can help avoid touching off other antennas or objects close by as well as helping with isolation by orientating the antenna in different directions in MIMO systems for when other TG.30 antennas are present on the same device.

This patented antenna is available in White and Black versions. The antenna blade can swivel 90 degrees from the connector accommodating different installation environments. It is also available with Straight and Right Angle connectors. For further information please contact your regional Taoglas customer support team.

2. Specification

Electrical								
Band	Frequency (MHz)	Measurement	Efficiency (%)	Average Gain (dB)	Peak Gain (dBi)	VSWR	Impedance	Polarization
5G NR/4G Band 5,8,12,13,14,17,18,20,26,27,28,29,71	617-960	Bent In Centre Of 30X30CM Ground plane	18.8	-7.26	1.40	3 Max	50Ω	Linear
		Bent In Free Space	58.5	-2.33	2.58			
		Bent On Edge Of 30X30CM Ground plane.	54.5	-2.64	2.77			
		In Centre Of 30X30CM Ground plane	56.9	-2.45	1.98			
		Straight In Free space.	54.8	-2.62	3.00			
		Straight On Edge Of 30X30CM Ground plane.	53.5	-2.72	2.66			
5G NR/4G Band 21,32,74,75,76	1427-1518	Bent In Centre Of 30X30CM Ground plane	66.3	-1.79	7.25			
		Bent In Free Space	50.4	-2.98	5.64			
		Bent On Edge Of 30X30CM Ground plane.	67.0	-1.74	2.49			
		In Centre Of 30X30CM Ground plane	54.6	-2.63	5.94			
		Straight In Free space.	49.8	-3.02	4.81			
		Straight On Edge Of 30X30CM Ground plane.	65.3	-1.85	3.10			
4G/3G Band 1,2,3,4,9,23,25,35,39,66	1710-2200	Bent In Centre Of 30X30CM Ground plane	62.8	-2.02	7.79			
		Bent In Free Space	82.7	-0.82	4.29			
		Bent On Edge Of 30X30CM Ground plane.	68.7	-1.63	2.99			
		In Centre Of 30X30CM Ground plane	70.8	-1.50	3.18			
		Straight In Free space.	78.3	-1.06	4.03			
		Straight On Edge Of 30X30CM Ground plane.	67.8	-1.69	3.91			
4G/3G Band 40	2300-2400	Bent In Centre Of 30X30CM Ground plane	42.3	-3.73	4.59			
		Bent In Free Space	81.7	-0.88	4.41			
		Bent On Edge Of 30X30CM Ground plane.	68.1	-1.67	3.50			
		In Centre Of 30X30CM Ground plane	61.5	-2.11	3.75			
		Straight In Free space.	75.0	-1.25	4.01			
		Straight On Edge Of 30X30CM Ground plane.	67.0	-1.74	3.63			
Wi-Fi 2400	2400-2500	Bent In Centre Of 30X30CM Ground plane	30.9	-5.10	3.10			
		Bent In Free Space	70.9	-1.49	4.18			
		Bent On Edge Of 30X30CM Ground plane.	64.0	-1.94	3.94			
		In Centre Of 30X30CM Ground plane	31.9	-4.96	2.49			
		Straight In Free space.	63.1	-2.00	3.32			
		Straight On Edge Of 30X30CM Ground plane.	59.3	-2.27	3.42			
4G/3G Band 7,38,41	2490-2690	Bent In Centre Of 30X30CM Ground plane	55.4	-2.56	7.06			
		Bent In Free Space	68.1	-1.67	4.41			

		Bent On Edge Of 30X30CM Ground plane.	49.8	-3.03	4.55
		In Centre Of 30X30CM Ground plane	38.3	-4.17	7.15
		Straight In Free space.	61.4	-2.12	4.73
		Straight On Edge Of 30X30CM Ground plane.	48.5	-3.15	4.67
5G NR/4G Band 22,42,43,48,77,78	3300-3800	Bent In Centre Of 30X30CM Ground plane	42.1	-3.76	6.60
		Bent In Free Space	42.1	-3.76	3.94
		Bent On Edge Of 30X30CM Ground plane.	33.7	-4.72	4.06
		In Centre Of 30X30CM Ground plane	34.0	-4.69	5.17
		Straight In Free space.	42.4	-3.73	4.84
		Straight On Edge Of 30X30CM Ground plane.	36.8	-4.34	4.20
LTE5200/ Wi-Fi 5800	5150-5925	Bent In Centre Of 30X30CM Ground plane	34.5	-4.62	7.09
		Bent In Free Space	67.1	-1.73	5.69
		Bent On Edge Of 30X30CM Ground plane.	43.2	-3.65	4.69
		In Centre Of 30X30CM Ground plane	41.2	-3.85	8.37
		Straight In Free space.	61.8	-2.09	6.52
		Straight On Edge Of 30X30CM Ground plane.	41.3	-3.84	4.34

Mechanical

Casing	UV Resistant PC/ABS
Flammability Rating	UL-94
Connector	SMA Male Hinged 90°

Environmental

Temperature Range	-40°C to 85°C
Humidity	Non-condensing 65°C 95% RH

5G/4G Bands								
Band Number	5GNR / FR1 / LTE / LTE-Advanced / WCDMA / HSPA / HSPA+ / TD-SCDMA							
	Uplink	Downlink	Bent (Centre) 30X30cm Ground plane	Bent in free space	Bent (Edge) 30x30cm Ground plane	Straight (Centre) 30X30cm Ground plane	Straight in free space	Straight (Edge) 30x30cm Ground plane
B1	1920 to 1980	2110 to 2170	✓	✓	✓	✓	✓	✓
B2	1850 to 1910	1930 to 1990	✓	✓	✓	✓	✓	✓
B3	1710 to 1785	1805 to 1880	✓	✓	✓	✓	✓	✓
B4	1710 to 1755	2110 to 2155	✓	✓	✓	✓	✓	✓
B5	824 to 849	869 to 894	✓	✓	✓	✓	✓	✓
B7	2500 to 2570	2620 to 2690	✓	✓	✓	✓	✓	✓
B8	880 to 915	925 to 960	✓	✓	✓	✓	✓	✓
B9*	1749.9 to 1784.9	1844.9 to 1879.9	✓	✓	✓	✓	✓	✓
B11	1427.9 to 1447.9	1475.9 to 1495.9	✓	✓	✓	✗	✓	✓
B12	699 to 716	729 to 746	✗	✓	✓	✓	✓	✓
B13	777 to 787	746 to 756	✓	✓	✓	✓	✓	✓
B14	788 to 798	758 to 768	✓	✓	✓	✓	✓	✓
B17	704 to 716	734 to 746	✗	✓	✓	✓	✓	✓
B18	815 to 830	860 to 875	✓	✓	✓	✓	✓	✓
B19	830 to 845	875 to 890	✓	✓	✓	✓	✓	✓
B20	832 to 862	791 to 821	✓	✓	✓	✓	✓	✓
B21	1447.9 to 1462.9	1495.9 to 1510.9	✓	✓	✓	✓	✓	✓
B22*	3410 to 3490	3510 to 3590	✓	✓	✗	✓	✓	✓
B23*	2000 to 2020	2180 to 2200	✓	✓	✓	✓	✓	✓
B24	1626.5 to 1660.5	1525 to 1559	✓	✓	✓	✓	✓	✓
B25	1850 to 1915	1930 to 1995	✓	✓	✓	✓	✓	✓
B26	814 to 849	859 to 894	✓	✓	✓	✓	✓	✓
B27*	807 to 824	852 to 869	✓	✓	✓	✓	✓	✓
B28	703 to 748	758 to 803	✗	✓	✓	✓	✓	✓
B29	717 to 728		✗	✓	✓	✓	✓	✓
B30	2305 to 2315	2350 to 2360	✓	✓	✓	✓	✓	✓
B31	452.5 to 457.5	462.5 to 467.5	✗	✗	✗	✗	✗	✗
B32	1452 to 1496		✓	✓	✓	✓	✓	✓
B34	2010 to 2025		✓	✓	✓	✓	✓	✓
B35	1850 to 1910		✓	✓	✓	✓	✓	✓
B36	1930 to 1990		✓	✓	✓	✓	✓	✓
B37	1910 to 1930		✓	✓	✓	✓	✓	✓
B38	2570 to 2620		✓	✓	✓	✓	✓	✓
B39	1880 to 1920		✓	✓	✓	✓	✓	✓
B40	2300 to 2400		✓	✓	✓	✓	✓	✓
B41	2496 to 2690		✓	✓	✓	✓	✓	✓
B42	3400 to 3600		✓	✓	✓	✓	✓	✓
B43	3600 to 3800		✓	✓	✓	✓	✓	✓
B45	1447 to 1467		✓	✓	✓	✓	✓	✓
B46	5150 to 5925		✓	✓	✓	✓	✓	✓
B47	5855 to 5925		✓	✓	✓	✓	✓	✓
B48	3550 to 3700		✓	✓	✓	✓	✓	✓
B49	3550 to 3700		✓	✓	✓	✓	✓	✓
B50	1432 to 1517		✓	✓	✓	✓	✓	✓
B51	1427 to 1432		✓	✓	✓	✗	✓	✓
B52	3300 to 3400		✗	✓	✗	✗	✓	✗
B53	2483.5 to 2495		✓	✓	✓	✓	✓	✓
B65	1920 to 2010	2110 to 2200	✓	✓	✓	✓	✓	✓
B66	1710 to 1780	2110 to 2200	✓	✓	✓	✓	✓	✓
B68	698 to 728	753 to 783	✗	✓	✓	✓	✓	✓
B69	2570 to 2620		✓	✓	✓	✓	✓	✓
B70	1695 to 1710	1995 to 2020	✓	✓	✓	✓	✓	✓
B71	663 to 698	617 to 652	✓	✓	✓	✓	✓	✓
B72	451 to 456	461 to 466	✗	✗	✗	✗	✗	✗
B73	450 to 455	460 to 465	✗	✗	✗	✗	✗	✗
B74	1427 to 1470	1475 to 1518	✓	✓	✓	✓	✓	✓
B75	1432 to 1517		✓	✓	✓	✓	✓	✓
B76	1427 to 1432		✓	✓	✓	✗	✓	✓
B77	3300 to 4200		✓	✓	✓	✓	✓	✓
B78	3300 to 3800		✓	✓	✓	✓	✓	✓
B79	4400 to 5000		✓	✓	✓	✓	✓	✓
B85	698 to 716	728 to 746	✗	✓	✓	✓	✓	✓
B87	410 to 415	420 to 425	✗	✗	✗	✗	✗	✗
B88	412 to 417	422 to 427	✗	✗	✗	✗	✗	✗

3. Antenna Characteristics

3.1 Return Loss

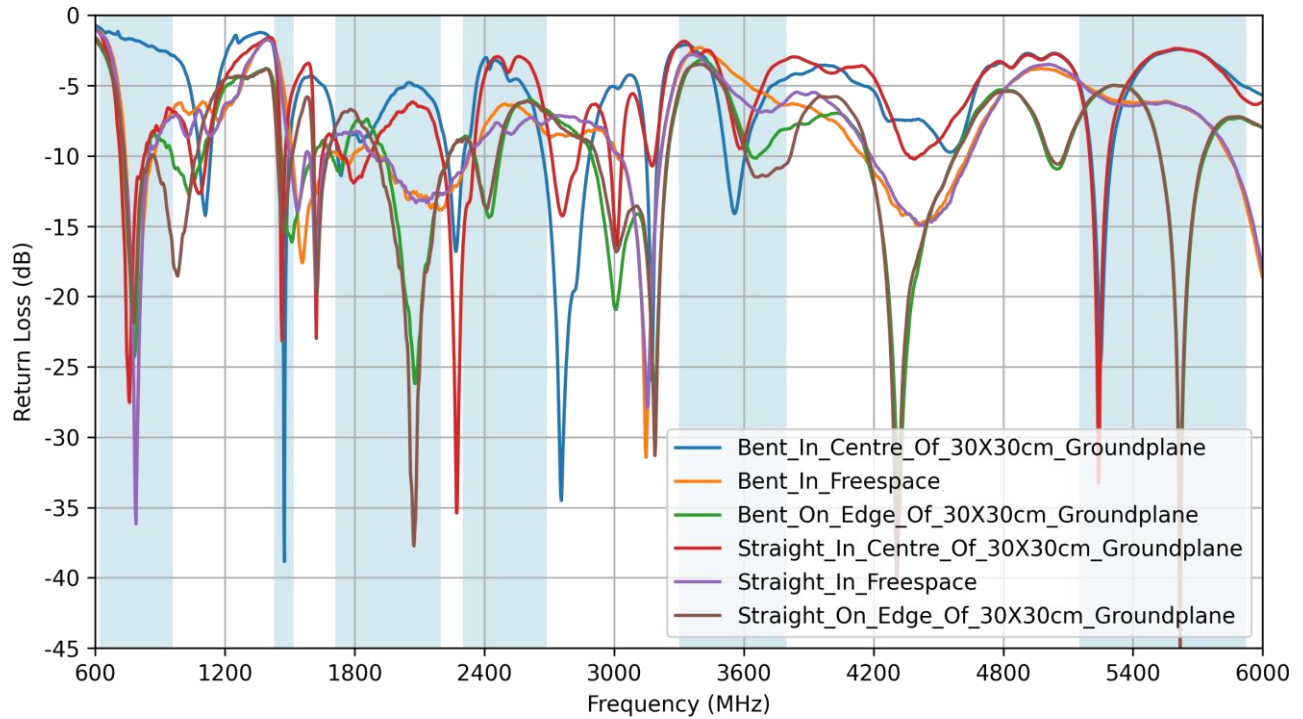

3.2 Efficiency

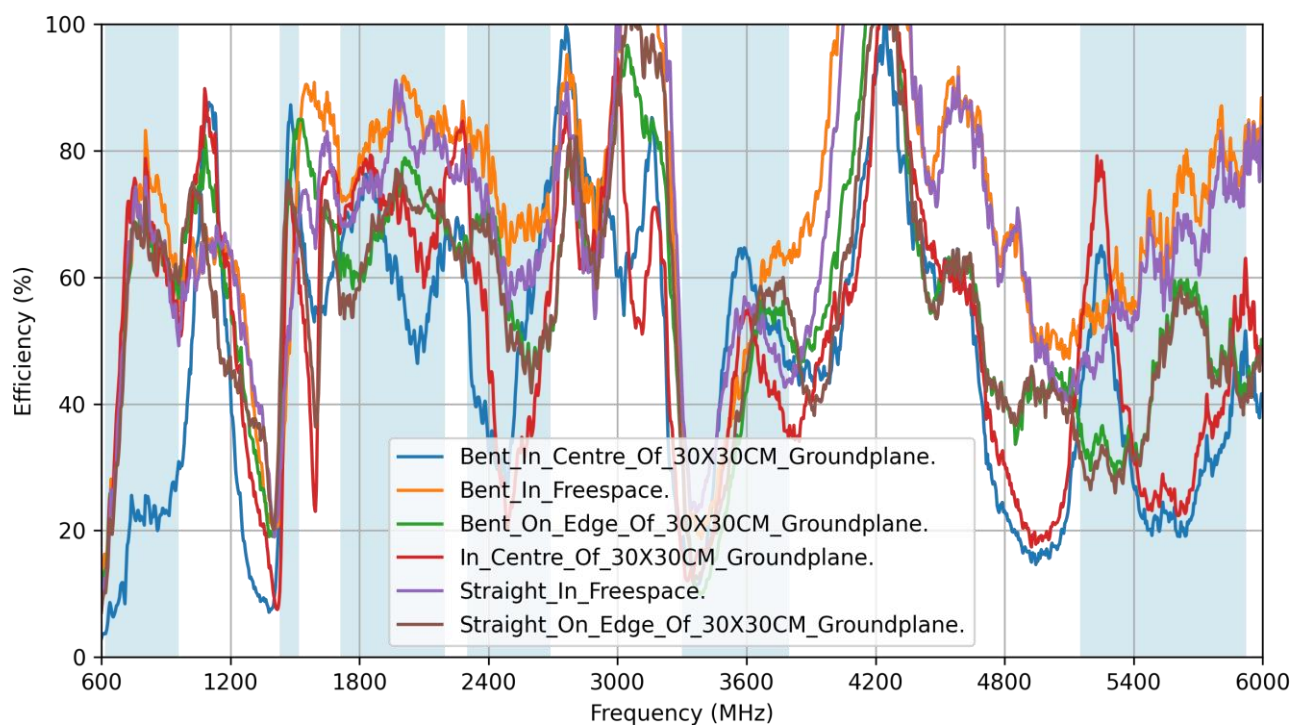

3.3 Average Gain

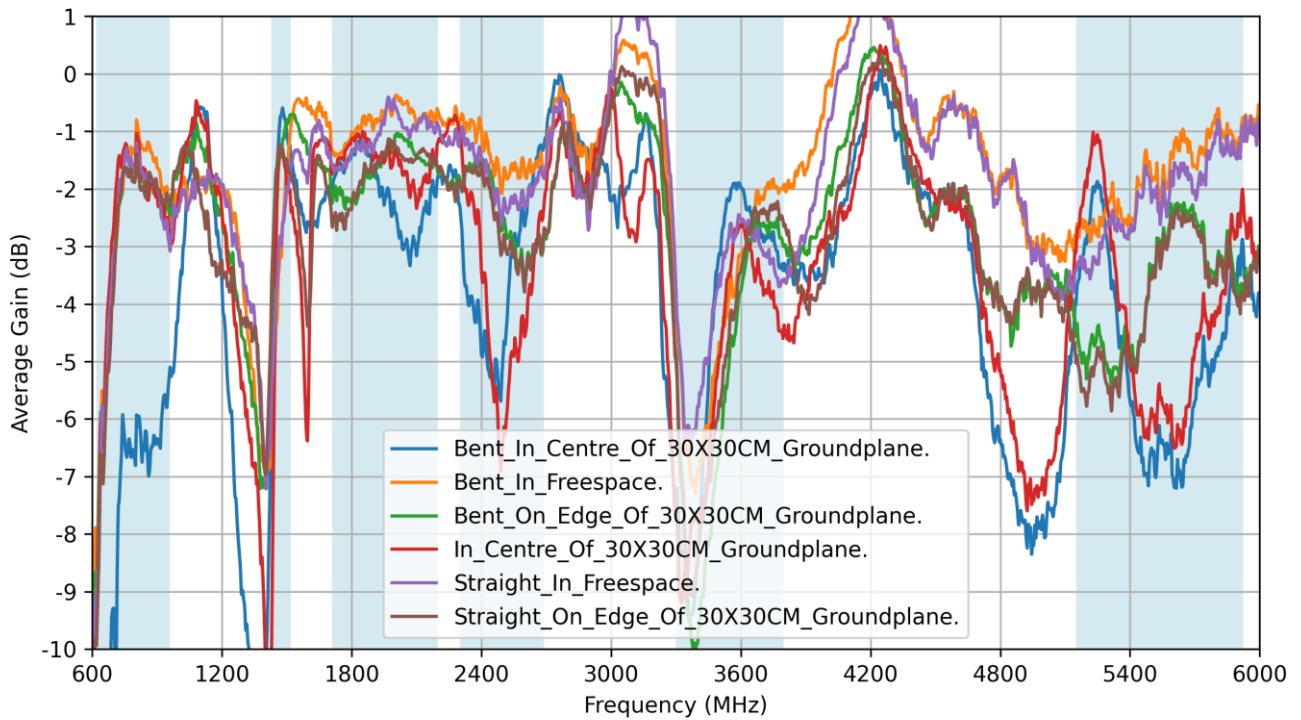

3.1 Peak Gain

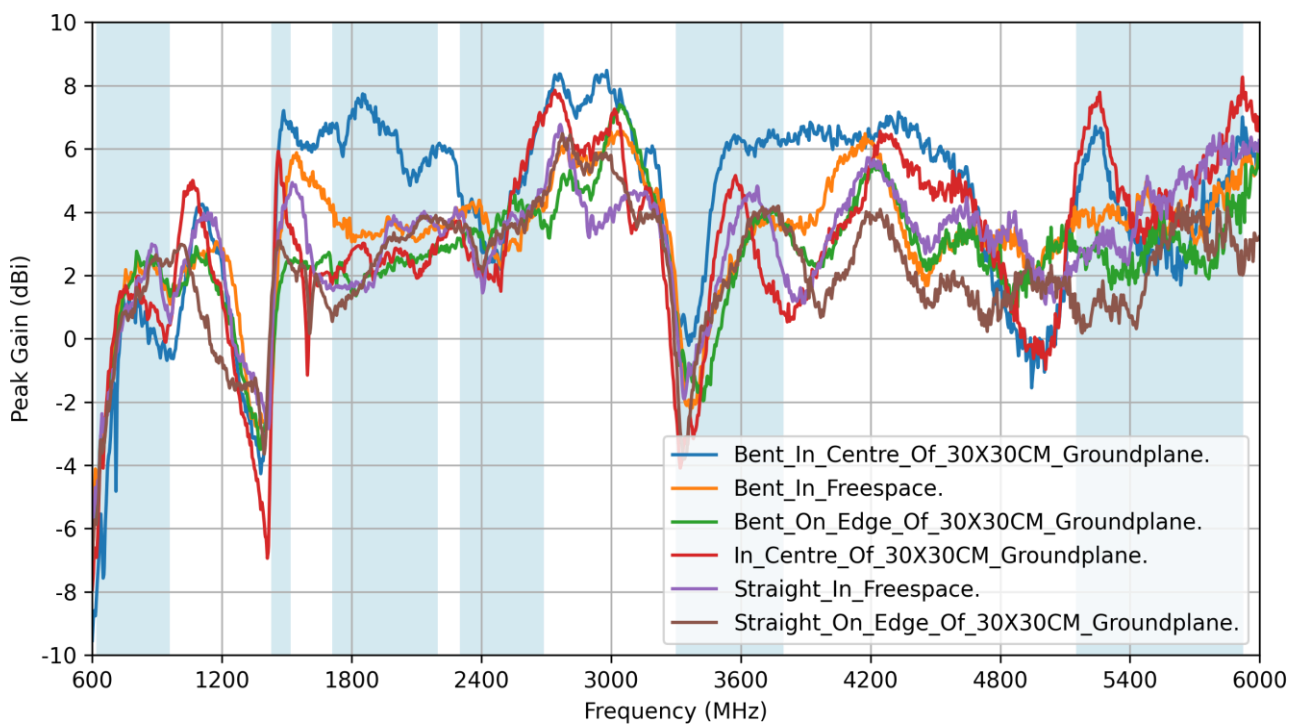

4. Radiation Patterns

4.1 Test Setup

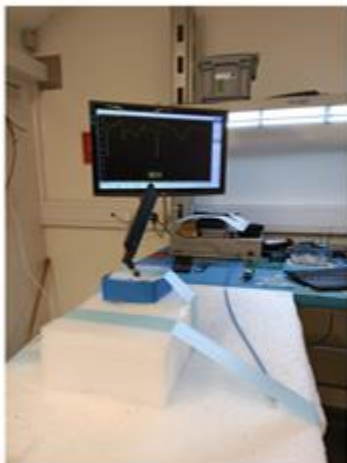
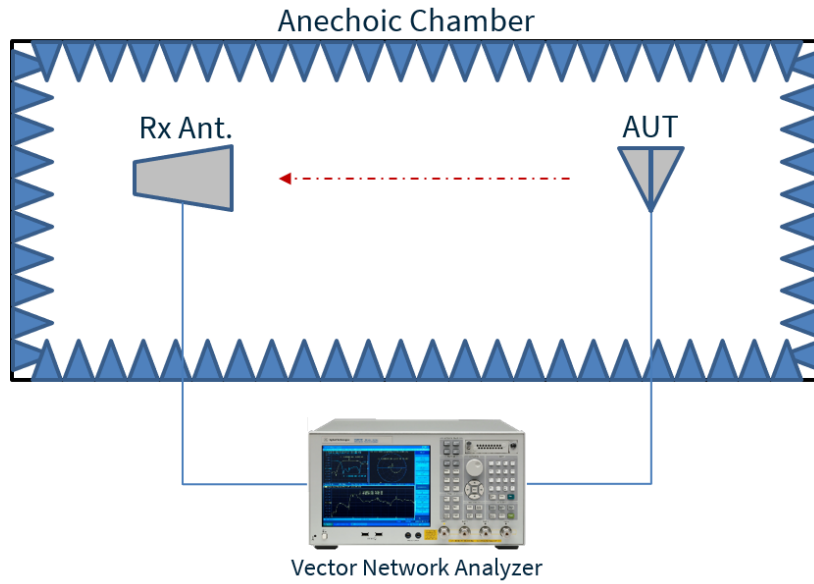

Chamber & VNA setup bent on the edge of a 30x30cm ground plane

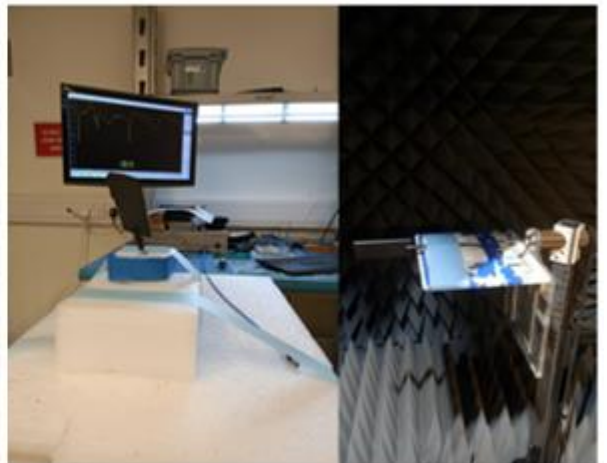
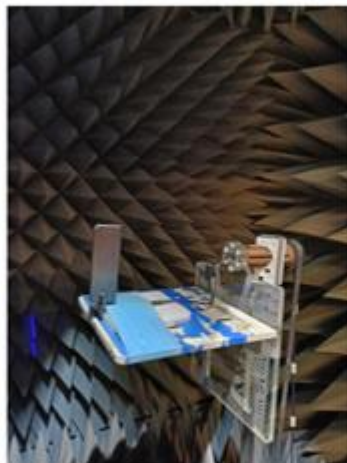

Chamber & VNA setup straight on the edge of a 30x30cm ground plane



Chamber & VNA setup bent in the middle of a 30x30cm ground plane

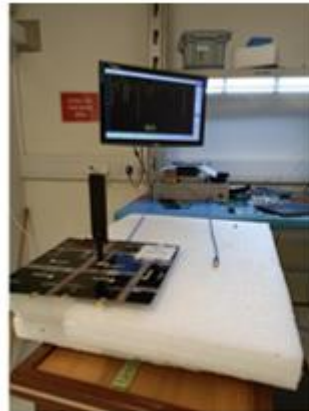
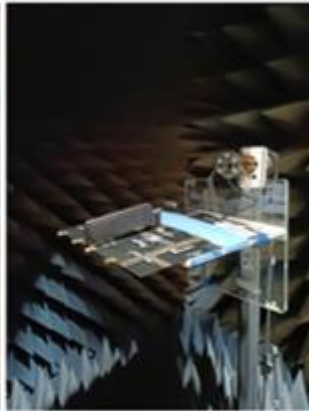

Chamber & VNA setup straight in the middle of a 30x30cm ground plane

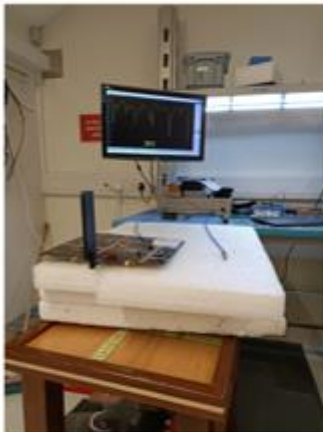
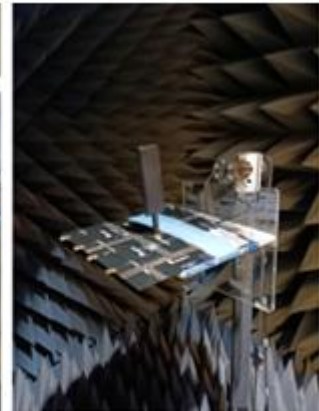

Chamber & VNA setup bent on the edge of a 30x30cm ground plane

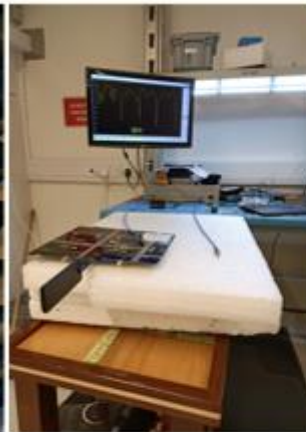
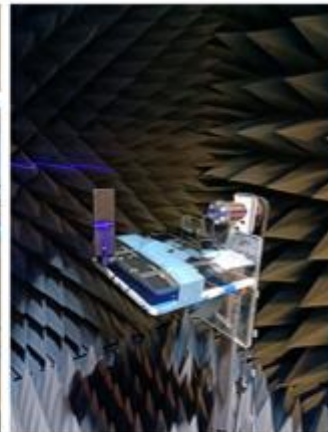

Chamber & VNA setup straight on the edge of a 30x30cm ground plane

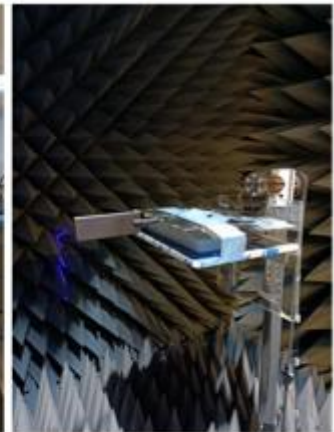

4.2 Bent (Centre) 30x30cm Ground plane - Patterns at 650 MHz

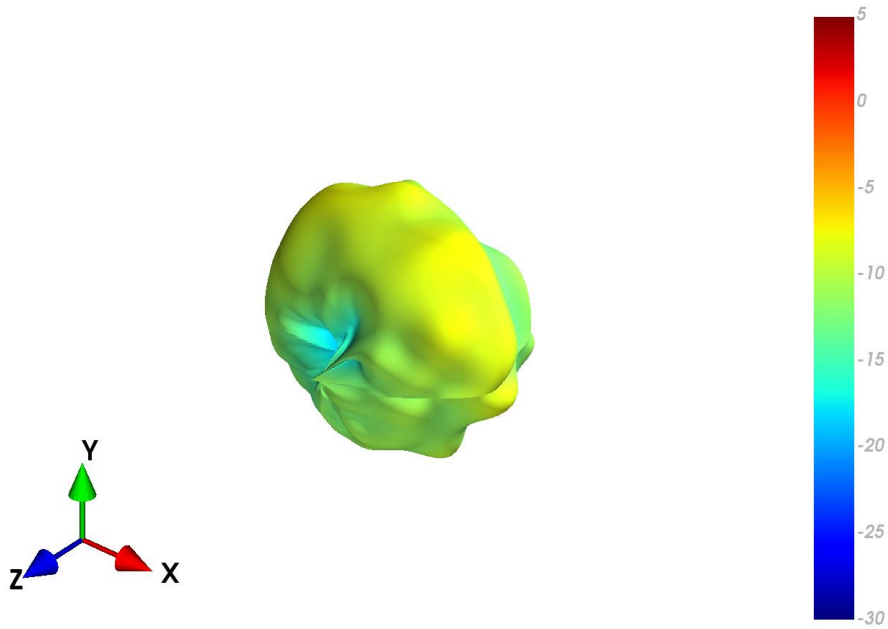

XZ Plane YZ Plane XY Plane

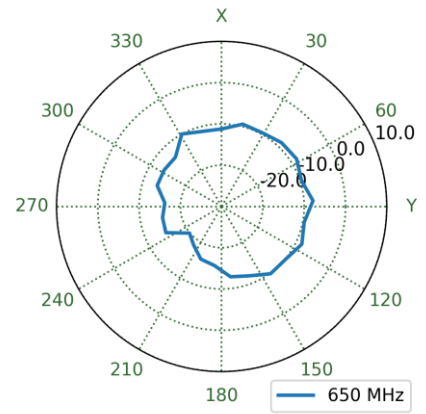
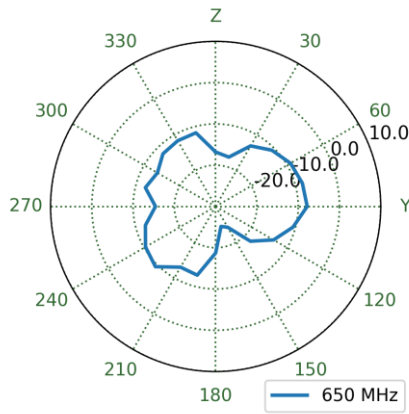
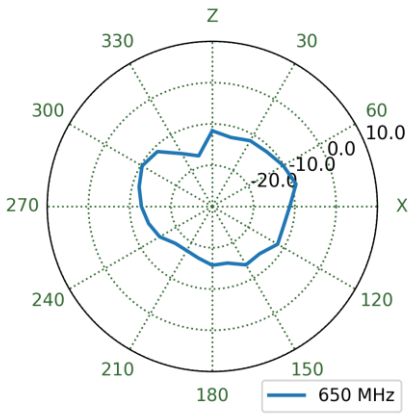

4.3 Bent in Free space -Patterns at 650 MHz

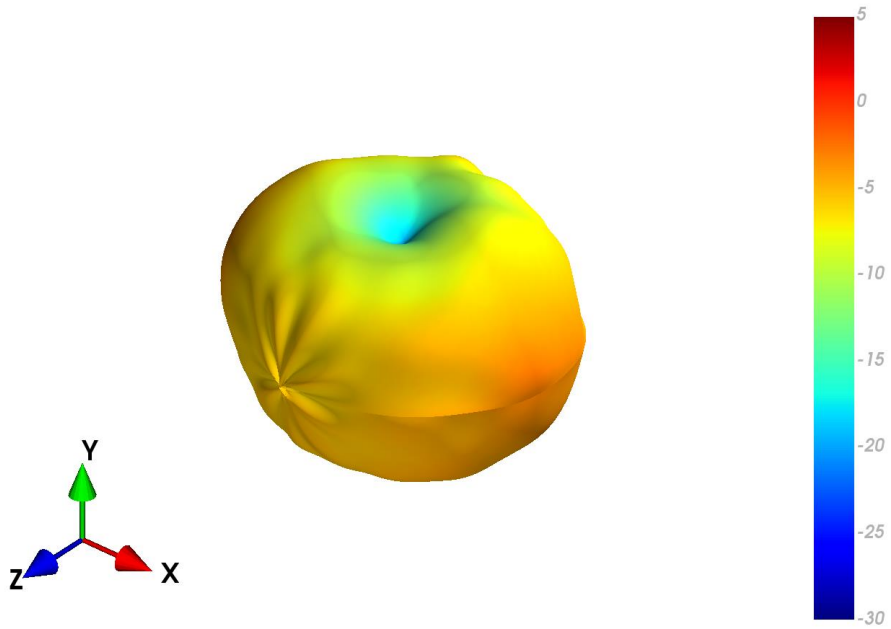

XZ Plane YZ Plane XY Plane

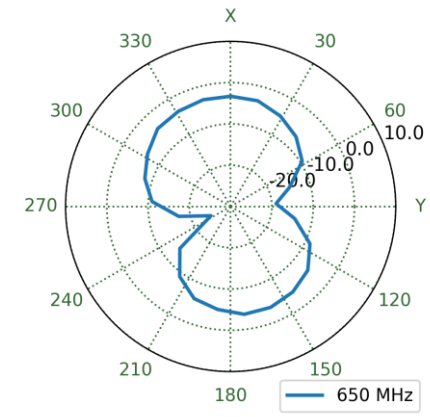
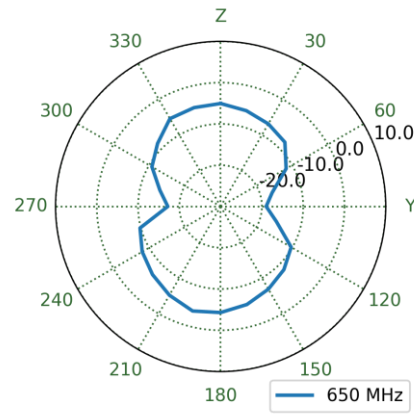
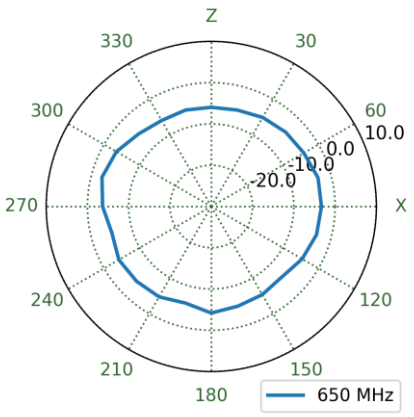

4.4 Bent (Edge) 30x30cm Ground plane - Patterns at 650 MHz

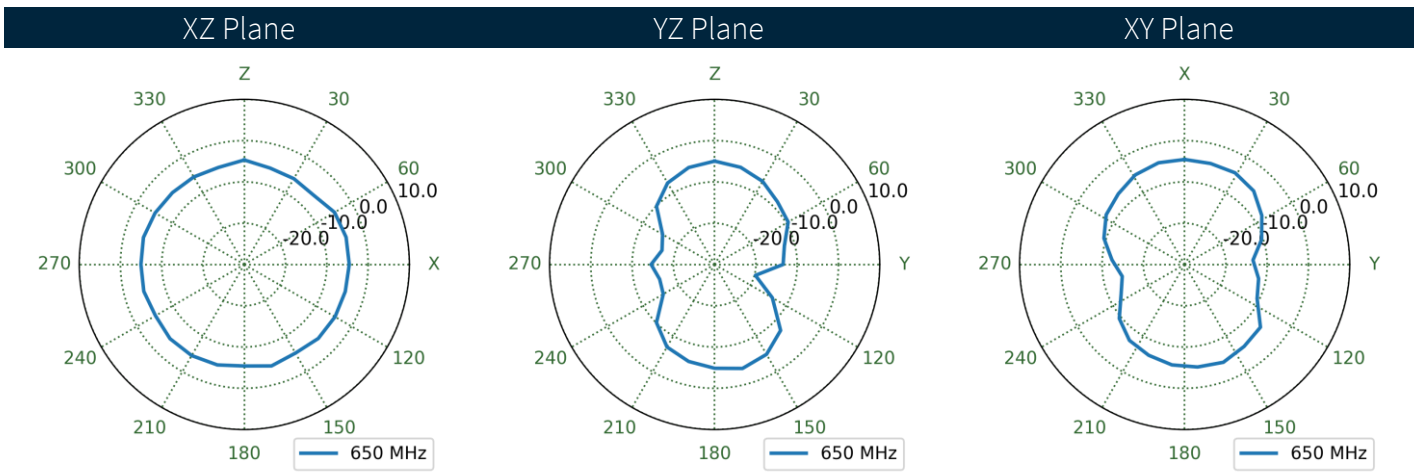
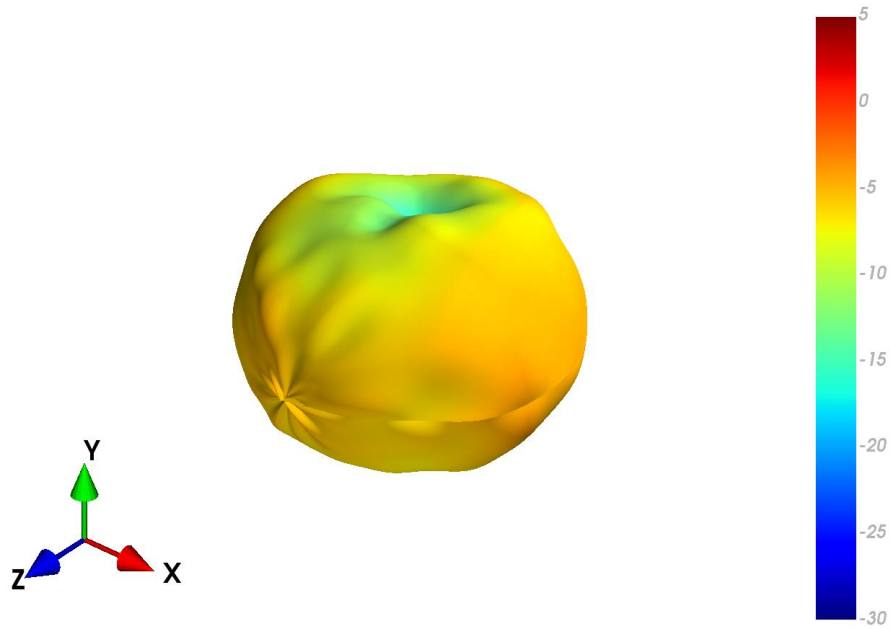

4.5 Straight (Centre) 30x30cm Ground plane - Patterns at 650 MHz

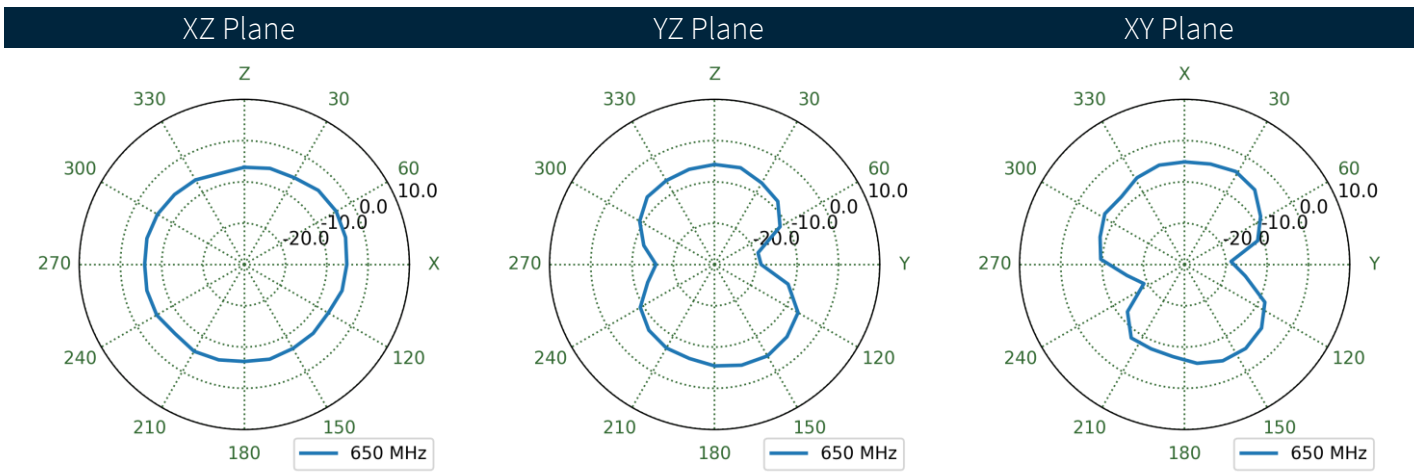
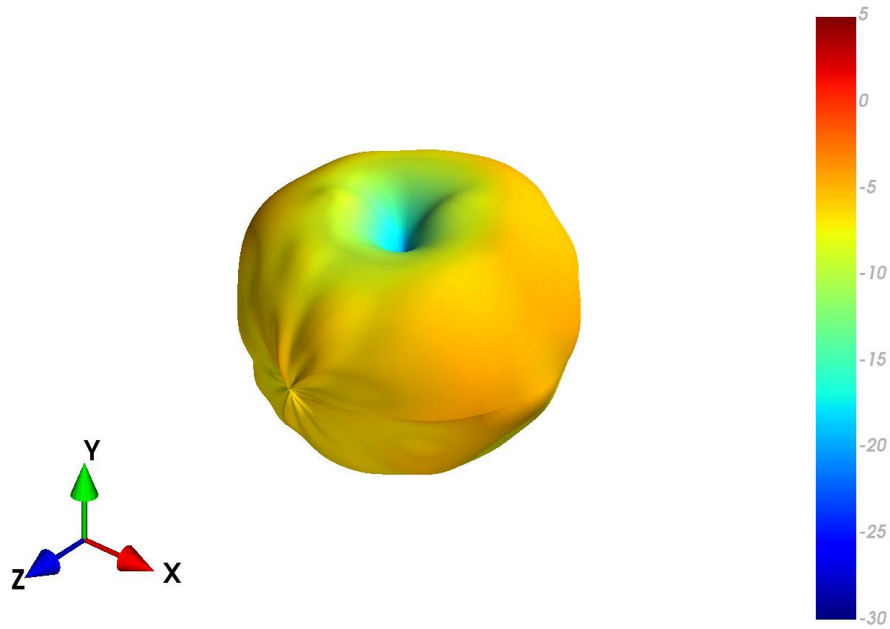

4.6 Straight in Free space - Patterns at 650 MHz

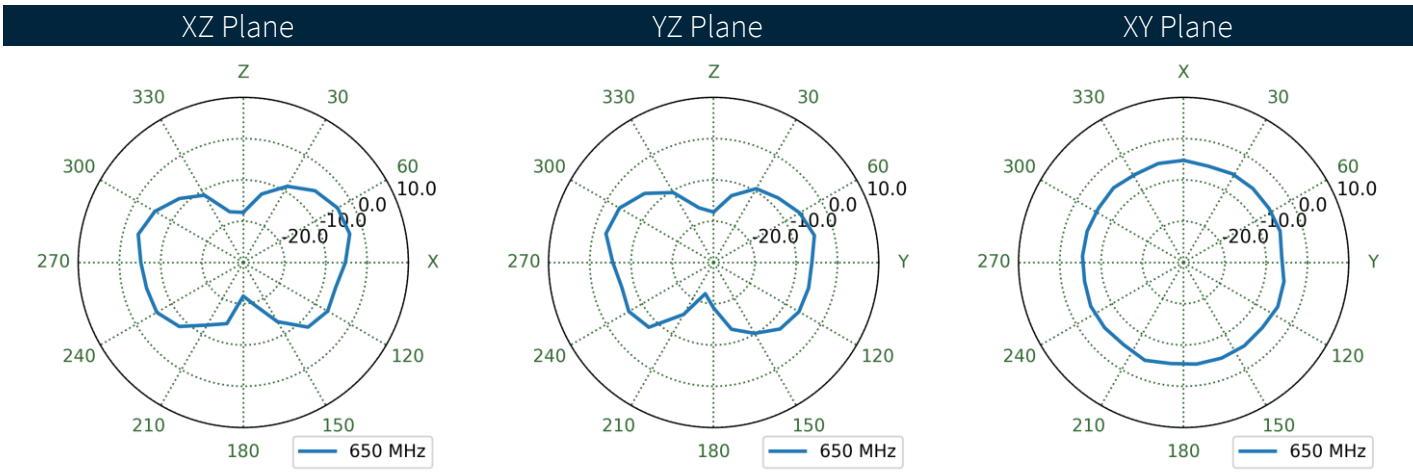
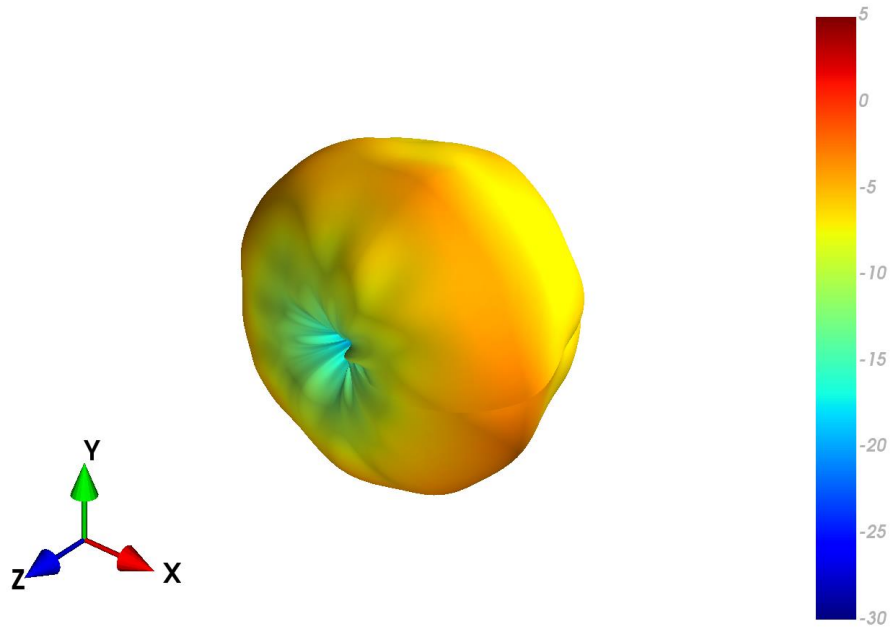

4.7 Straight (Edge) 30x30cm Ground plane - Patterns at 650 MHz

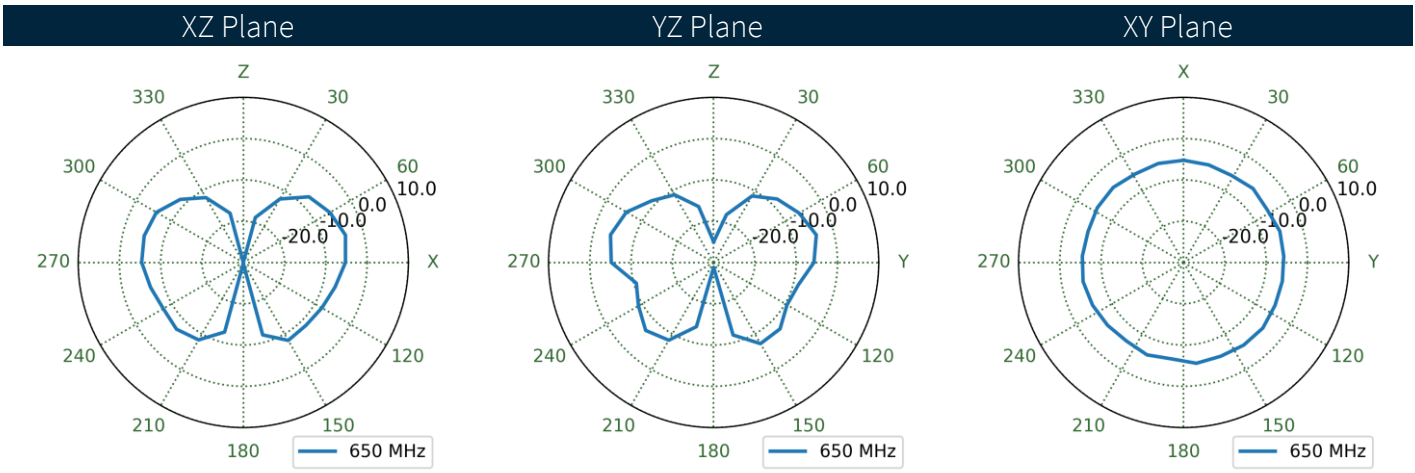
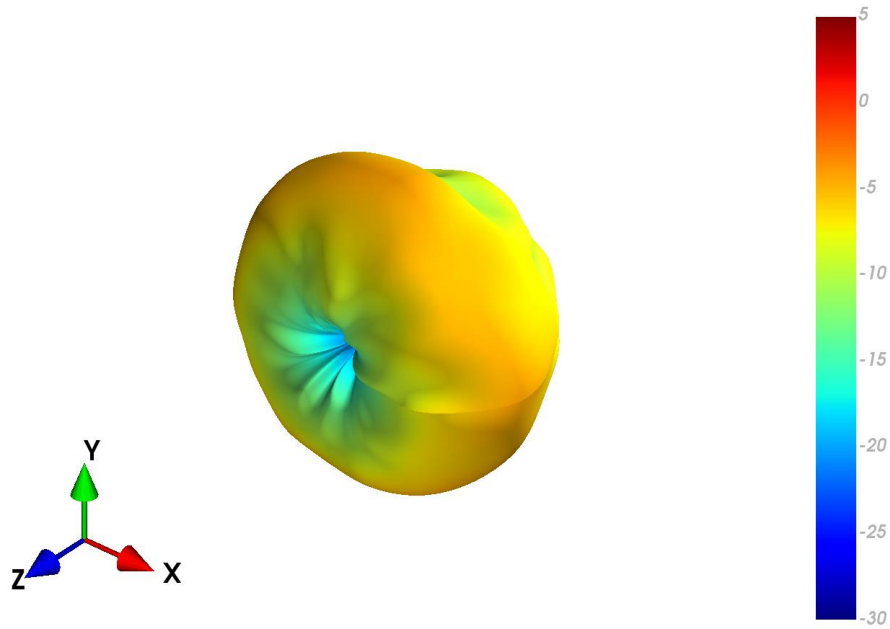

4.8 Bent (Centre) 30x30cm Ground plane - Patterns at 750 MHz

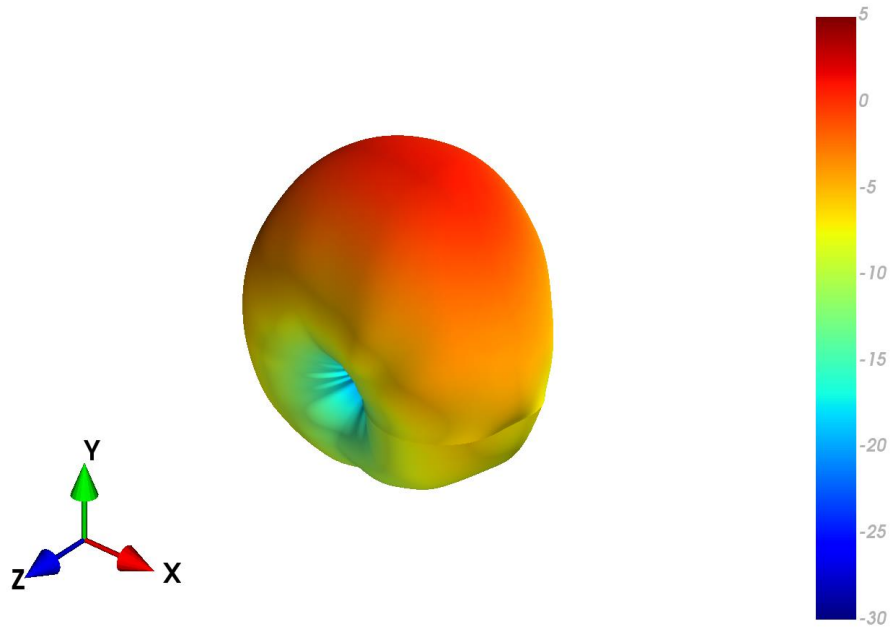

XZ Plane YZ Plane XY Plane

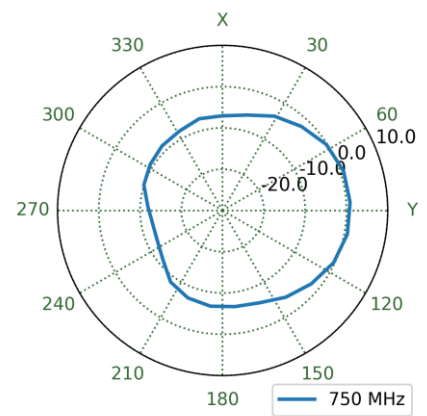
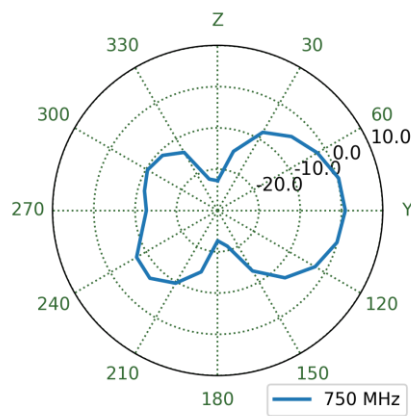
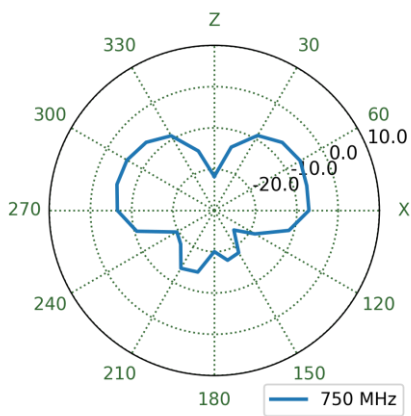

4.9 Bent in Free space -Patterns at 750 MHz

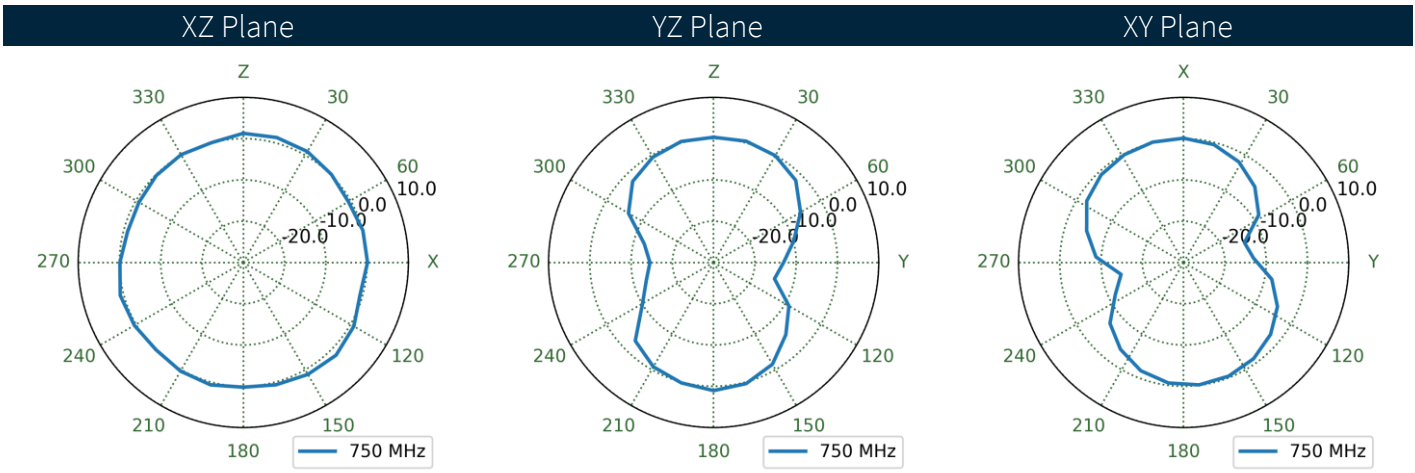
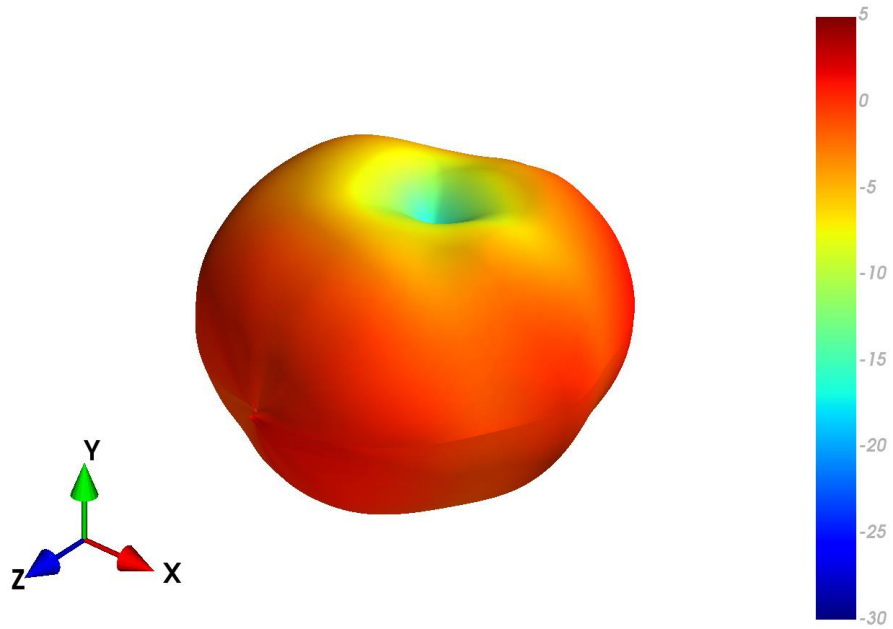

4.10 Bent (Edge) 30x30cm Ground plane - Patterns at 750 MHz

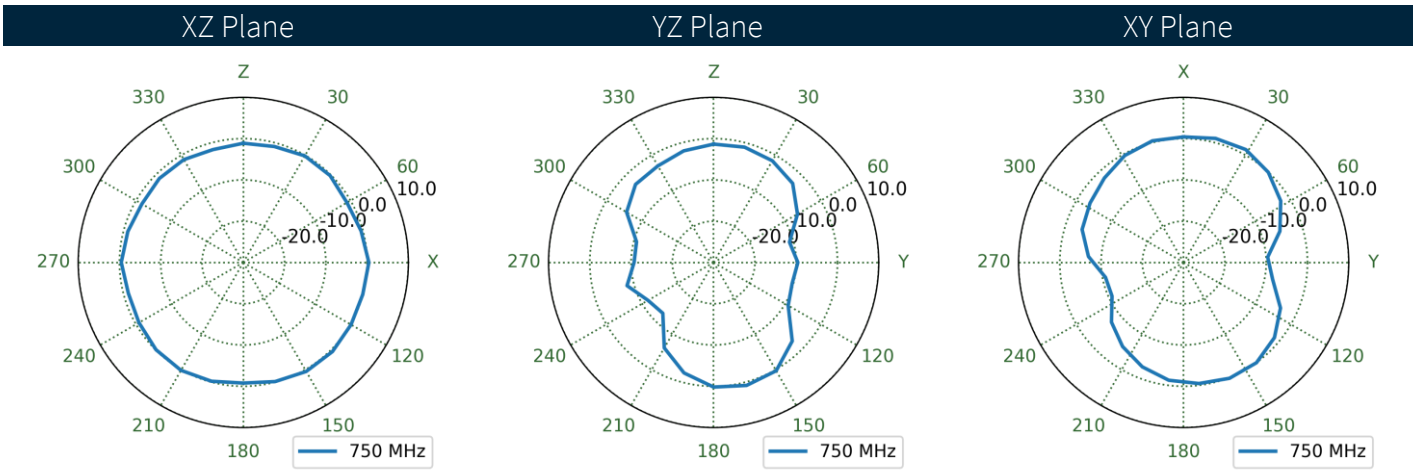
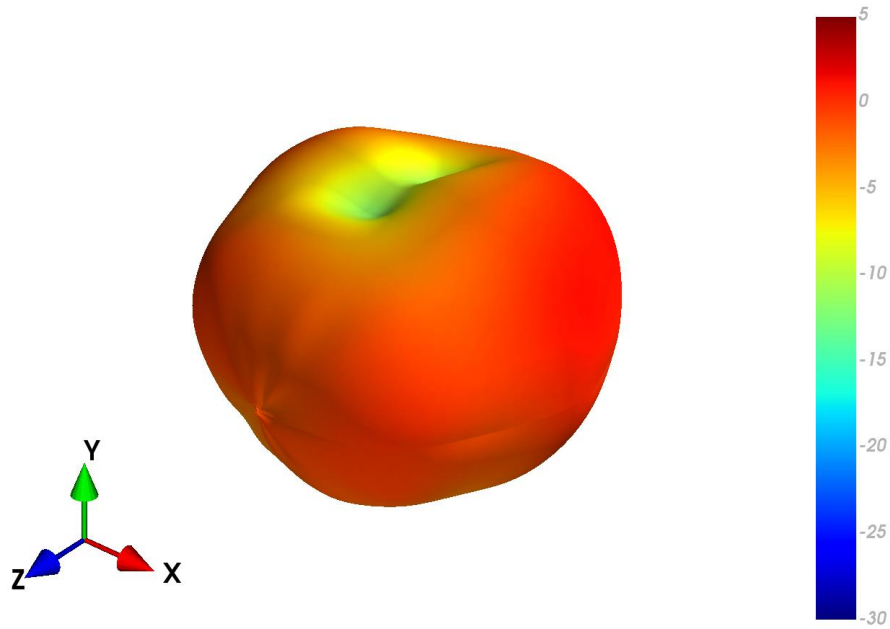

4.11 Straight (Centre) 30x30cm Ground plane -Patterns at 750 MHz

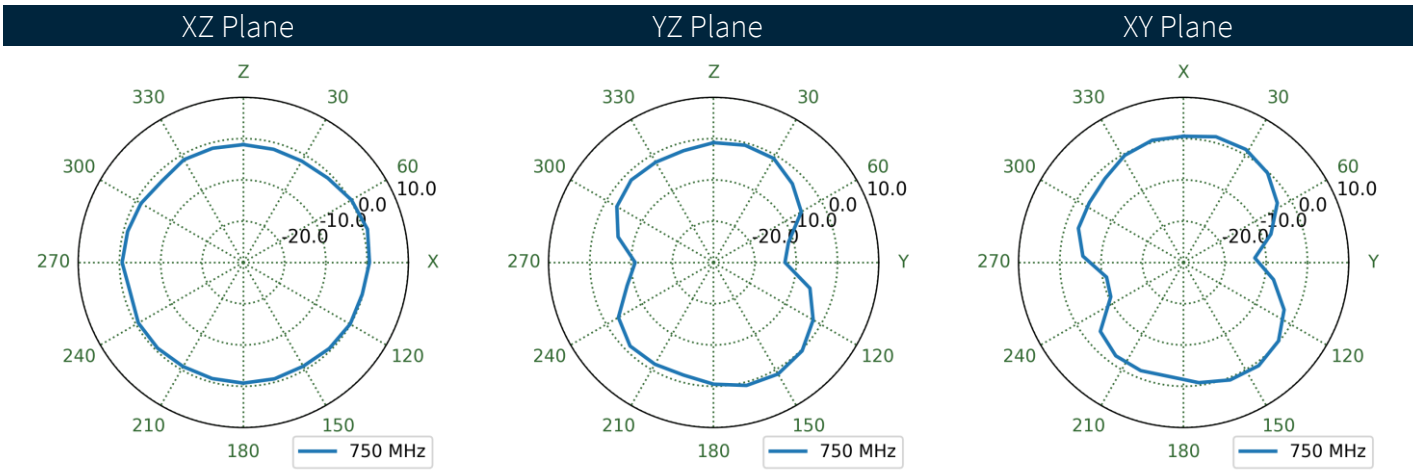
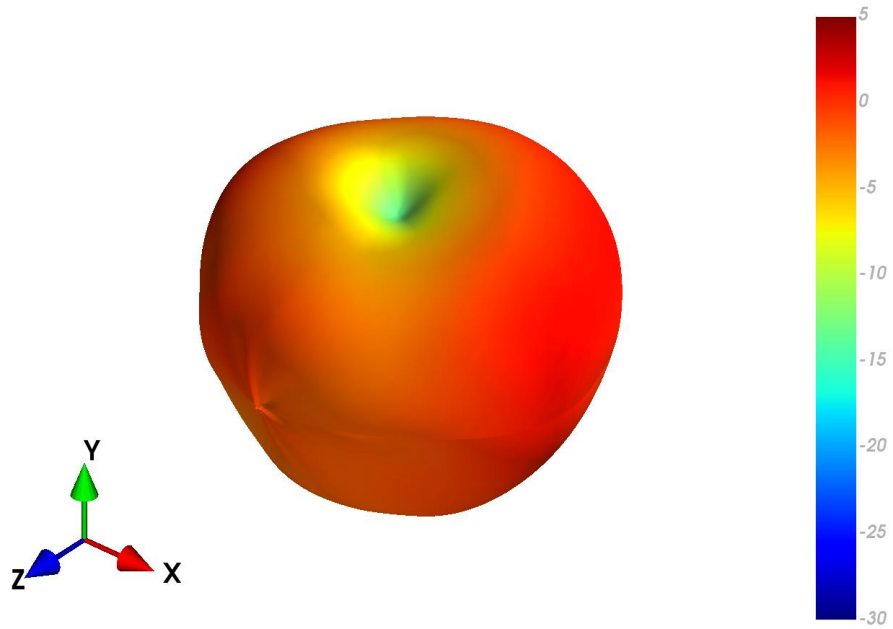

4.12 Straight in Free space - Patterns at 750 MHz

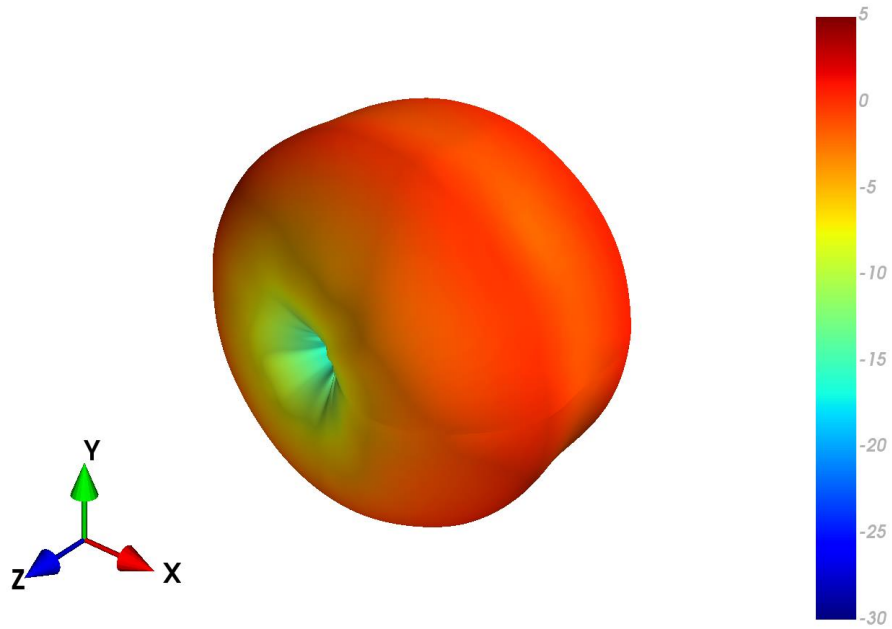

XZ Plane YZ Plane XY Plane

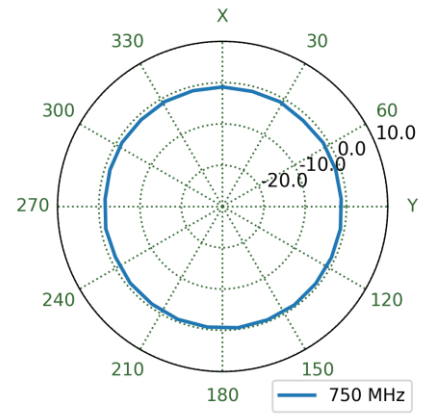
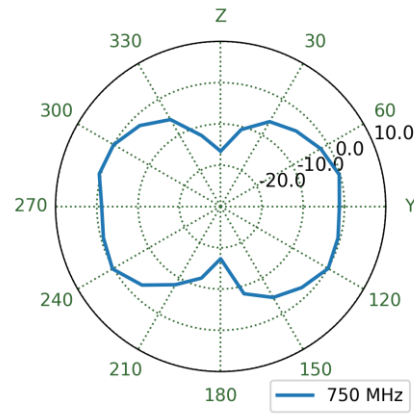
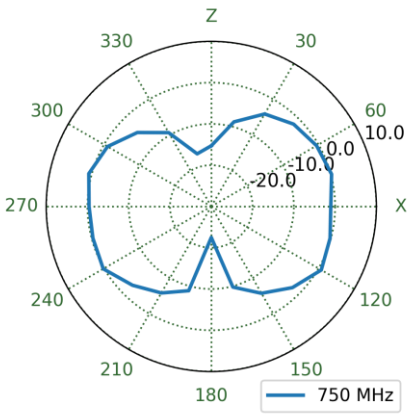

4.13 Straight (Edge) 30x30cm Ground plane - Patterns at 750 MHz

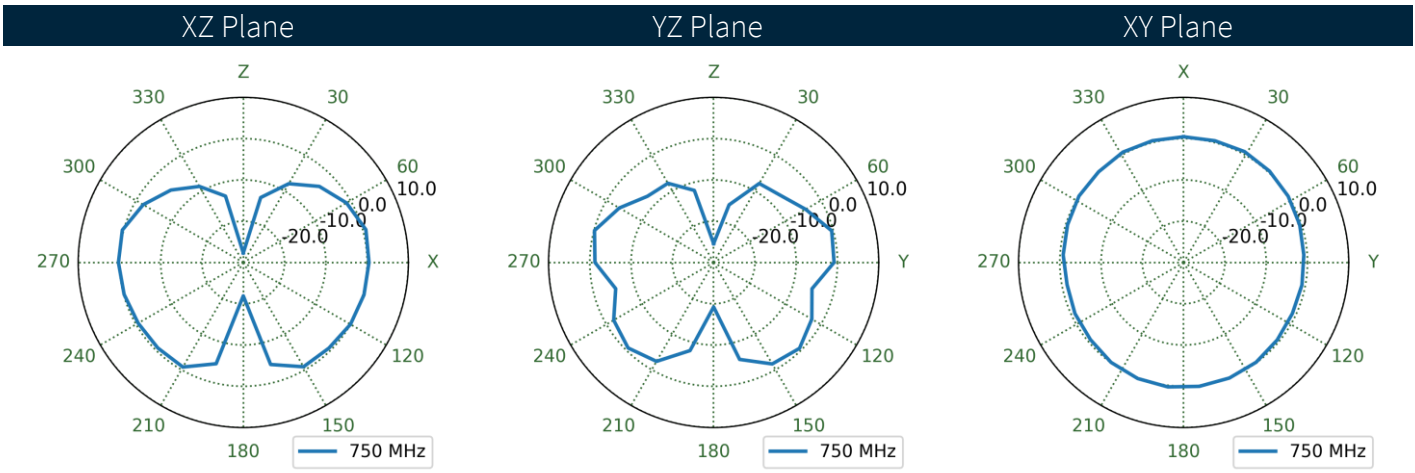
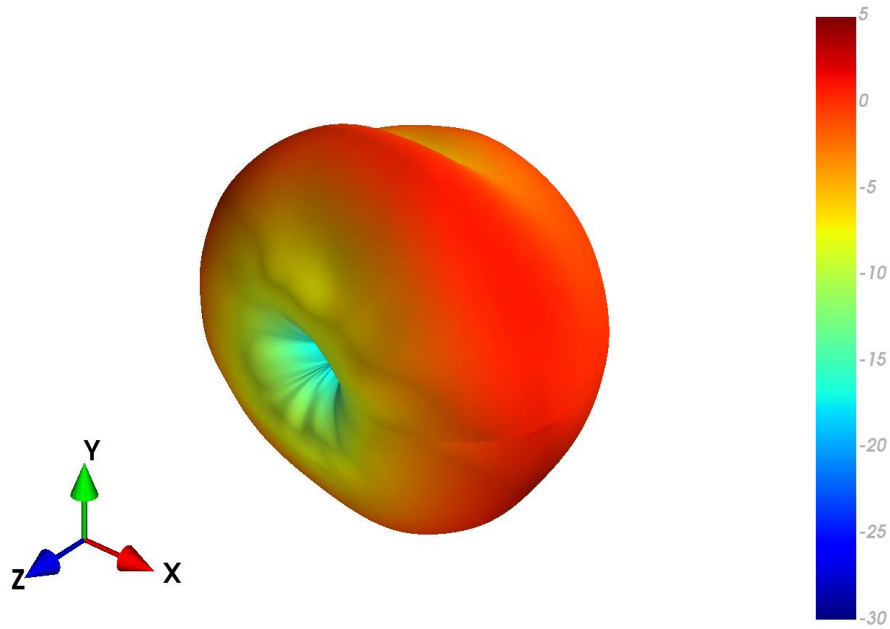

4.14 Bent (Centre) 30x30cm Ground plane - Patterns at 890 MHz

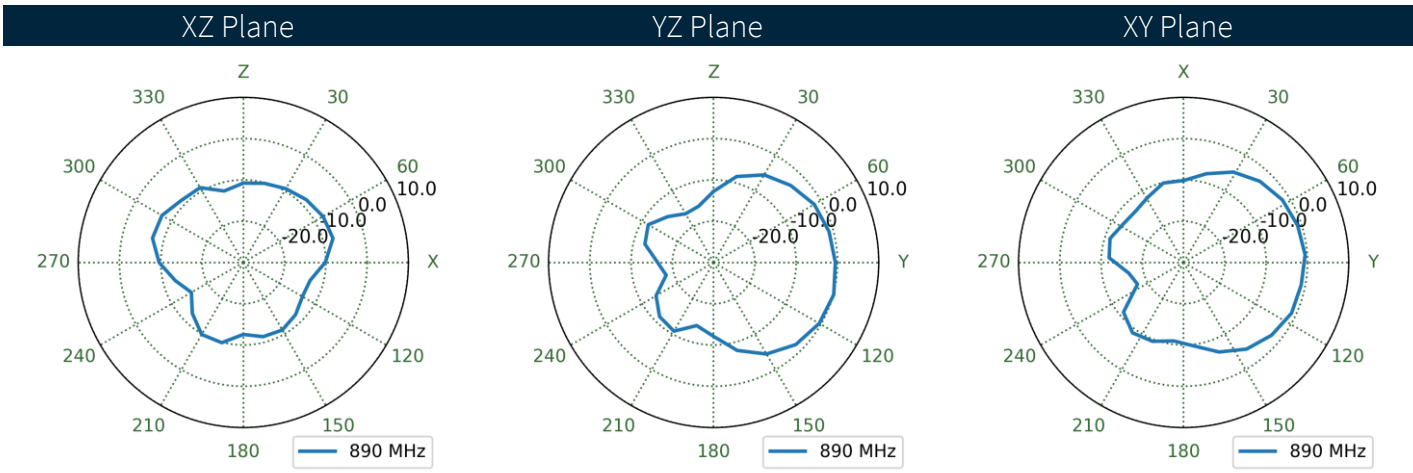
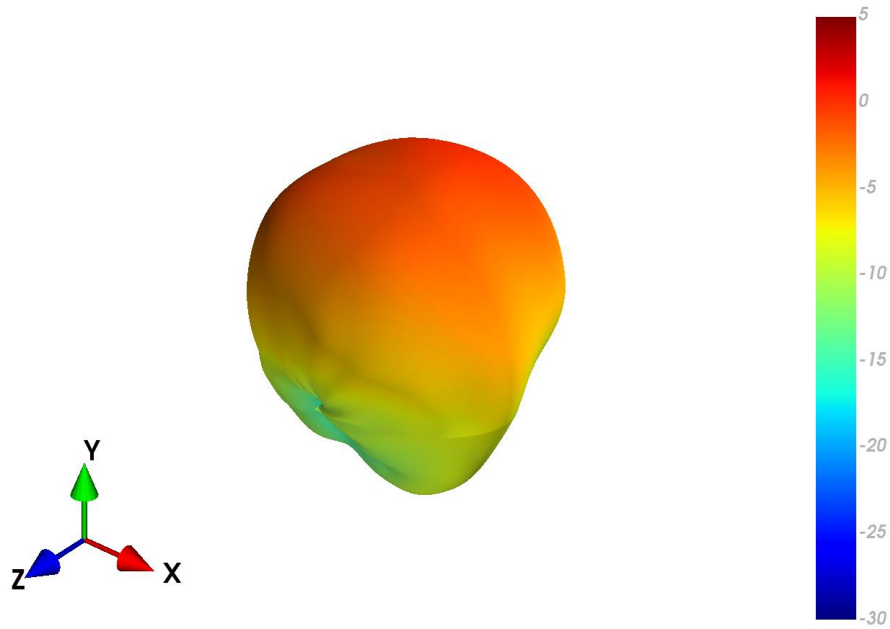

4.15 Bent in Free space - Patterns at 890 MHz

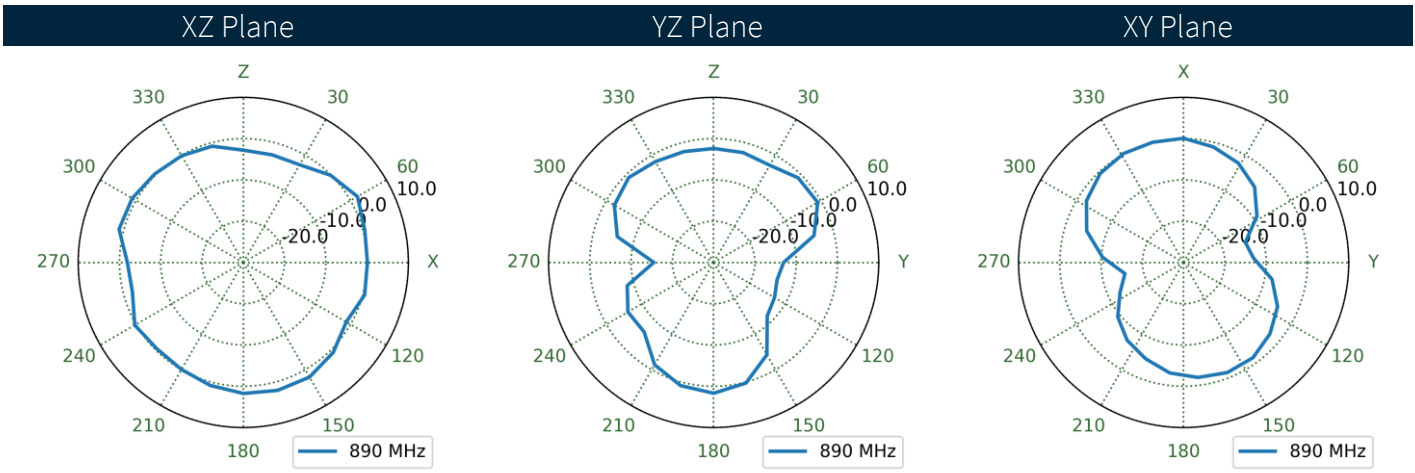
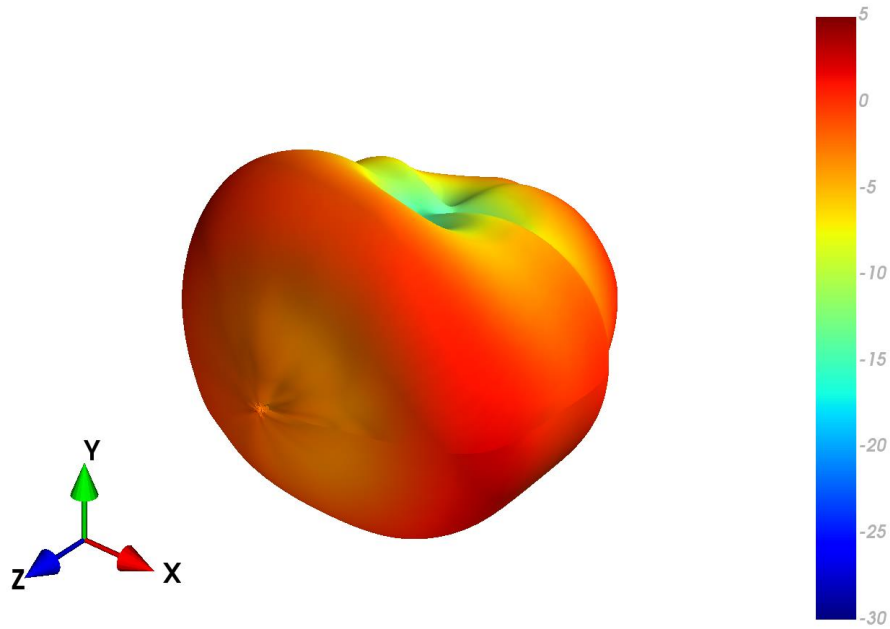

4.16 Bent (Edge) 30x30cm Ground plane - Patterns at 890 MHz

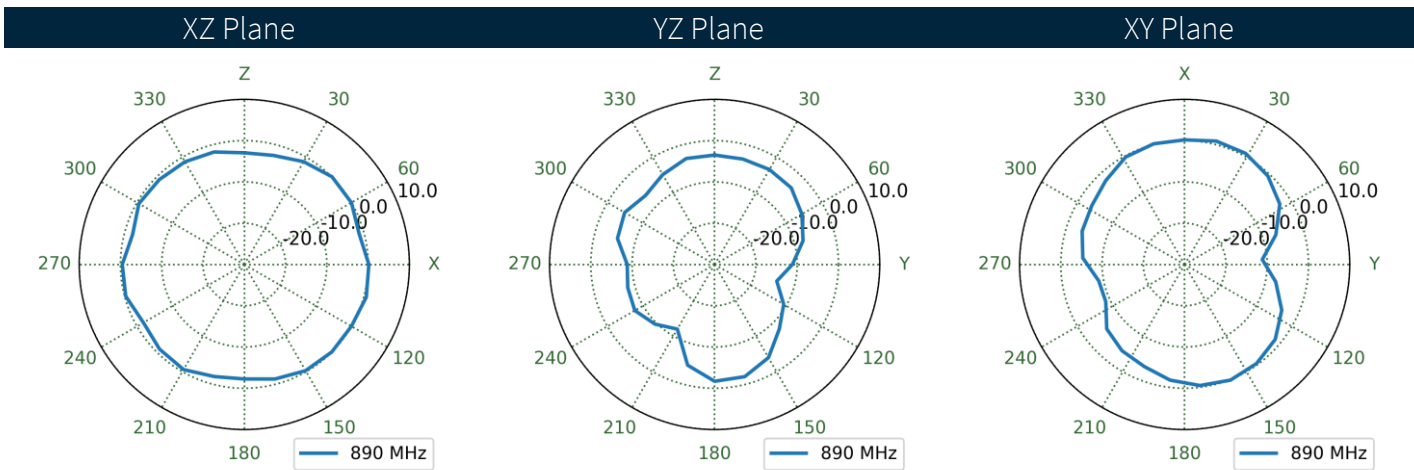
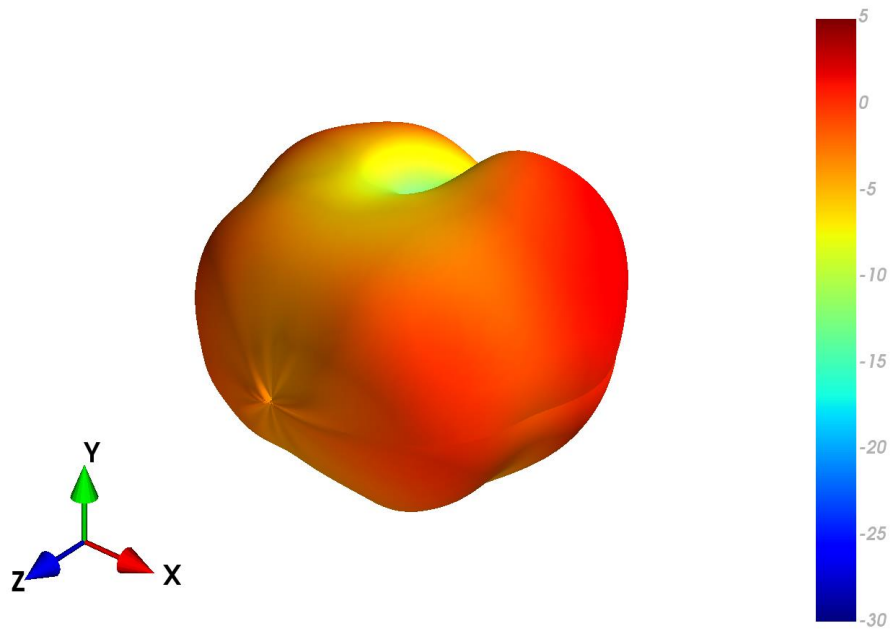

4.17 Straight (Centre) 30x30cm Ground plane - Patterns at 890 MHz

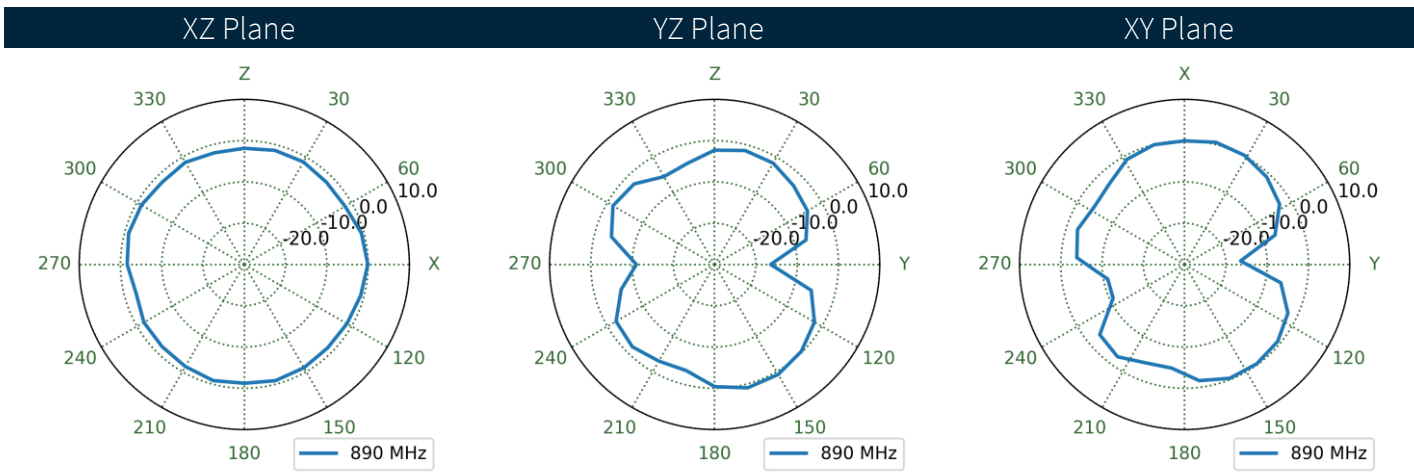
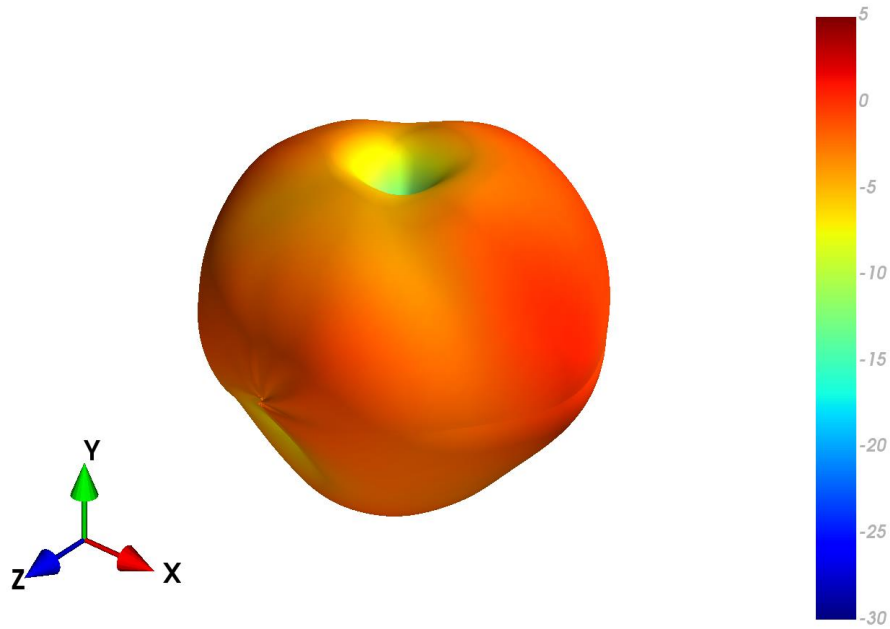

4.18 Straight in Free space - Patterns at 890 MHz

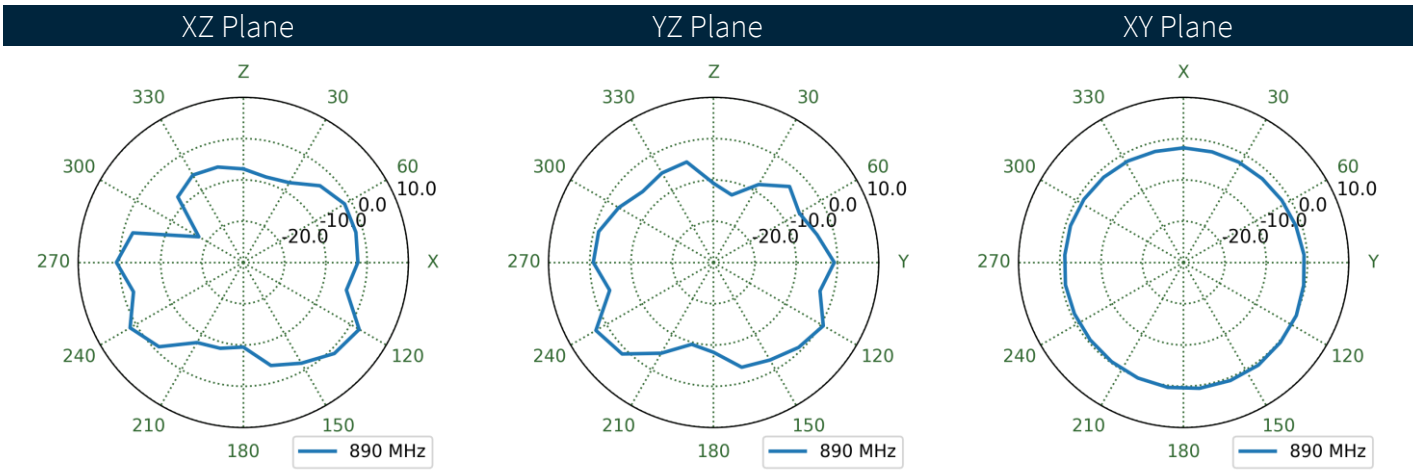
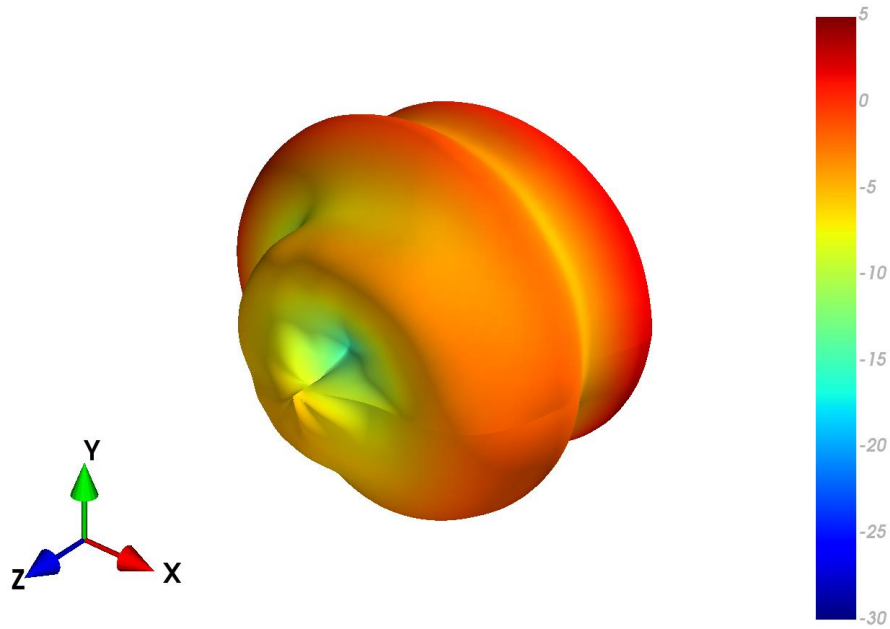

4.19 Straight (Edge) 30x30cm Ground plane - Patterns at 890 MHz

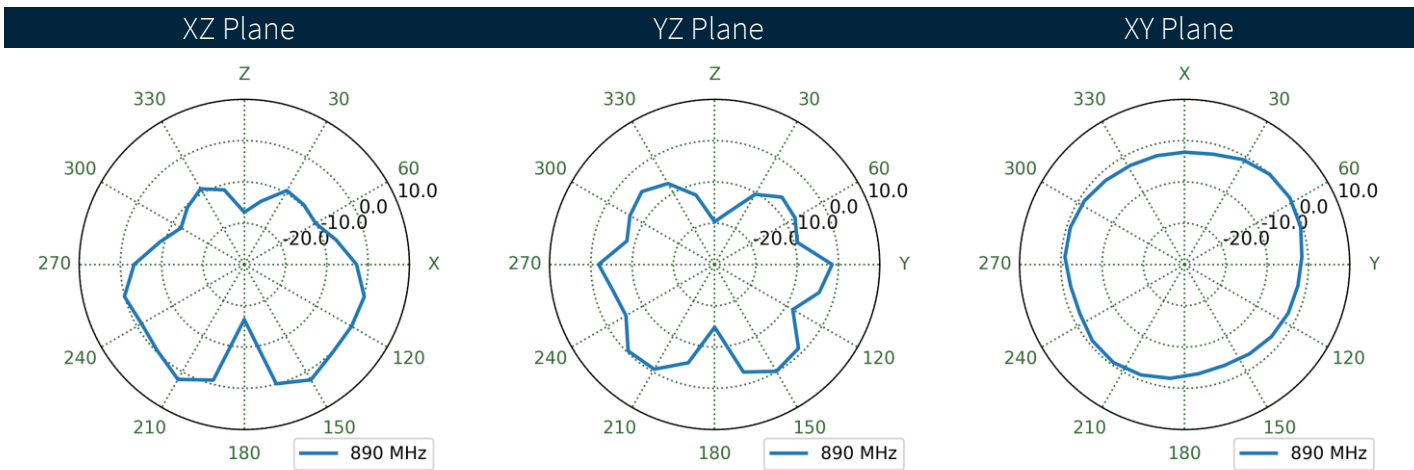
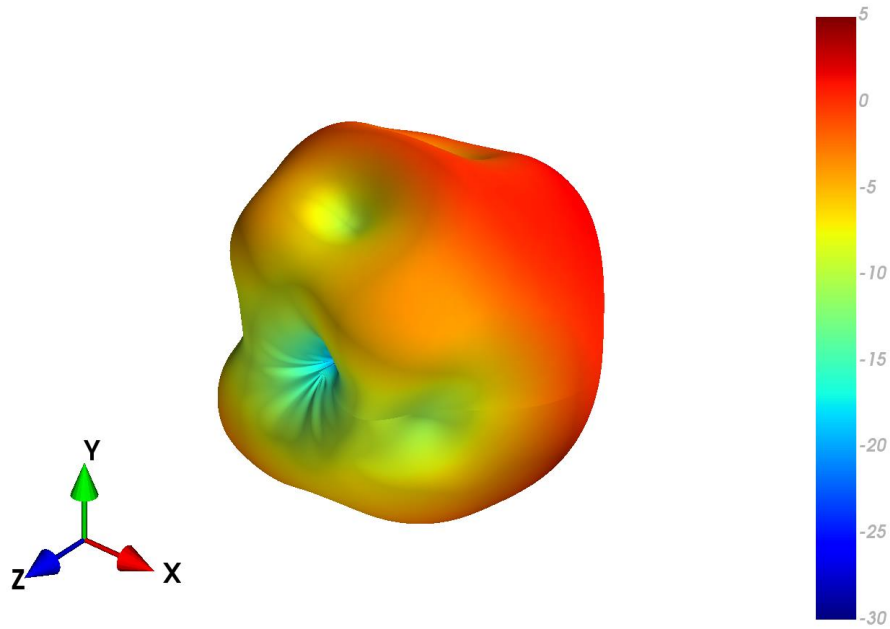

4.20 Bent (Centre) 30x30cm Ground plane - Patterns at 960 MHz

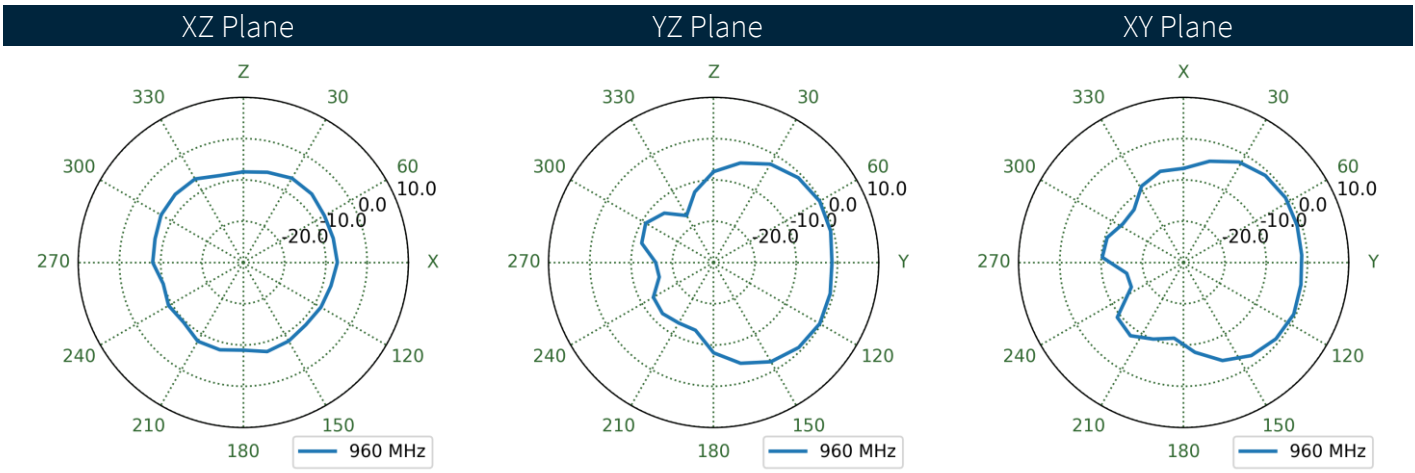
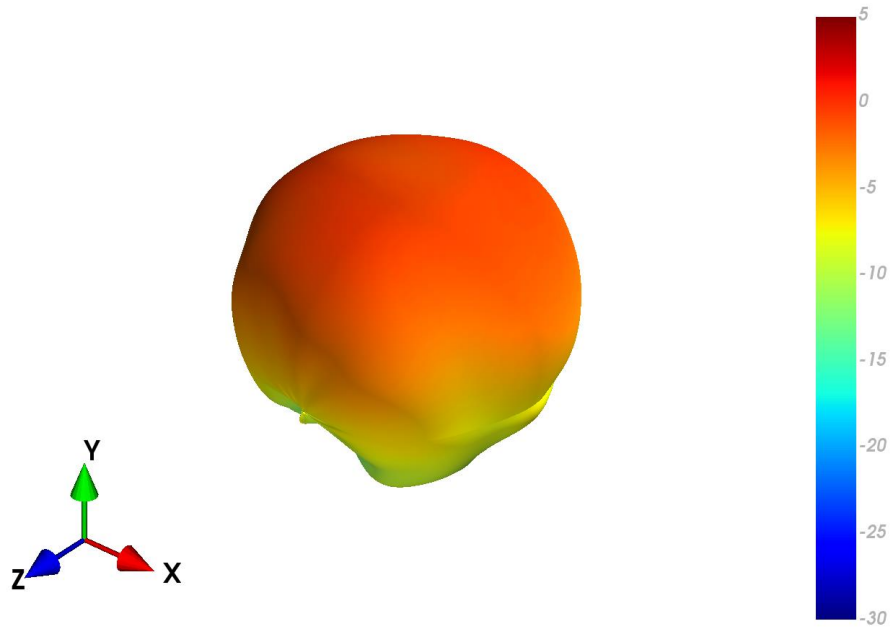

4.21 Bent in Free space - Patterns at 960 MHz

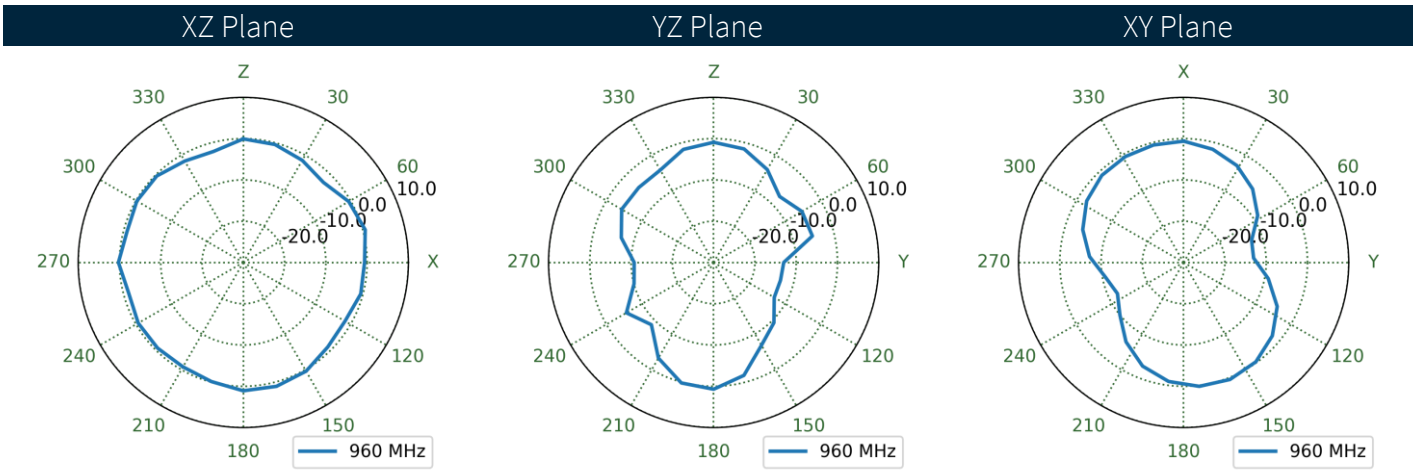
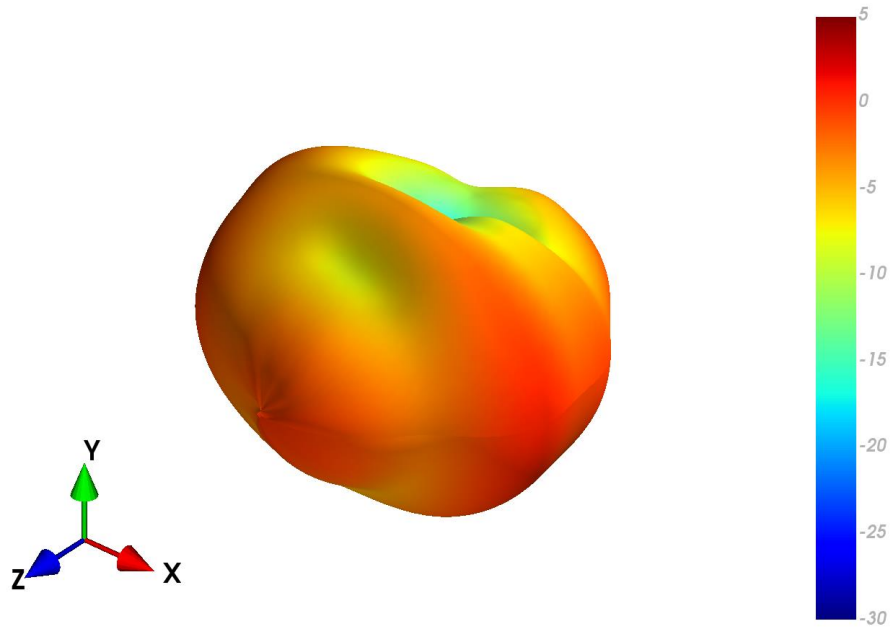

4.22 Bent (Edge) 30x30cm Ground plane - Patterns at 960 MHz

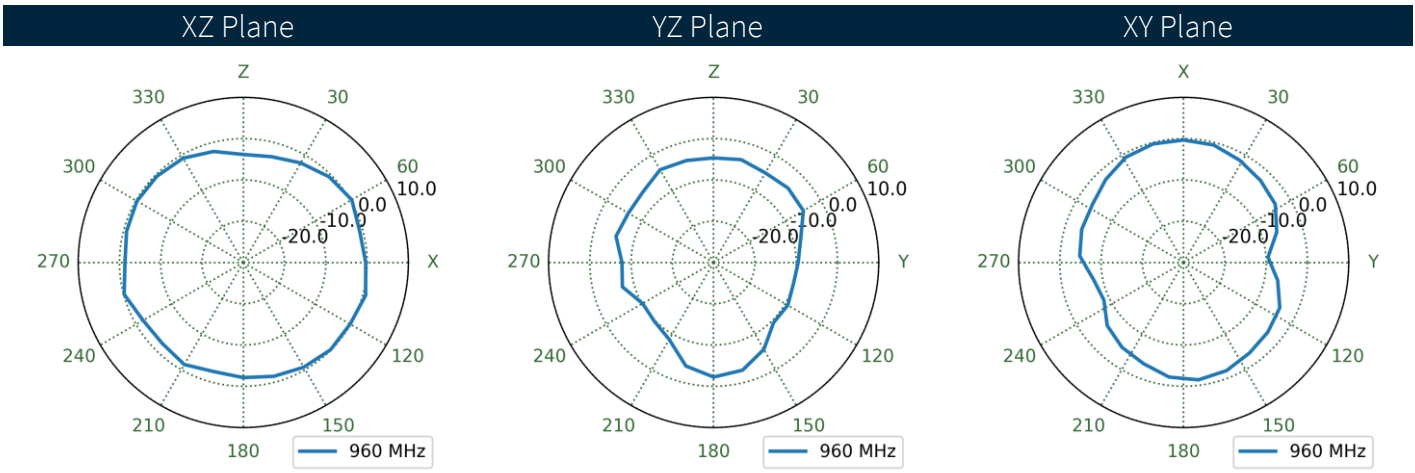
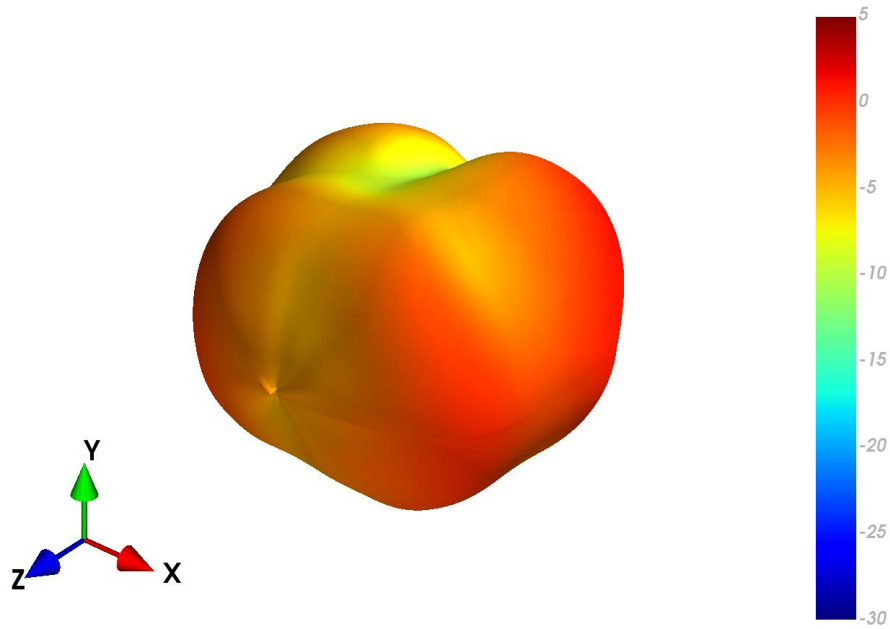

4.23 Straight (Centre) 30x30cm Ground plane - Patterns at 960 MHz

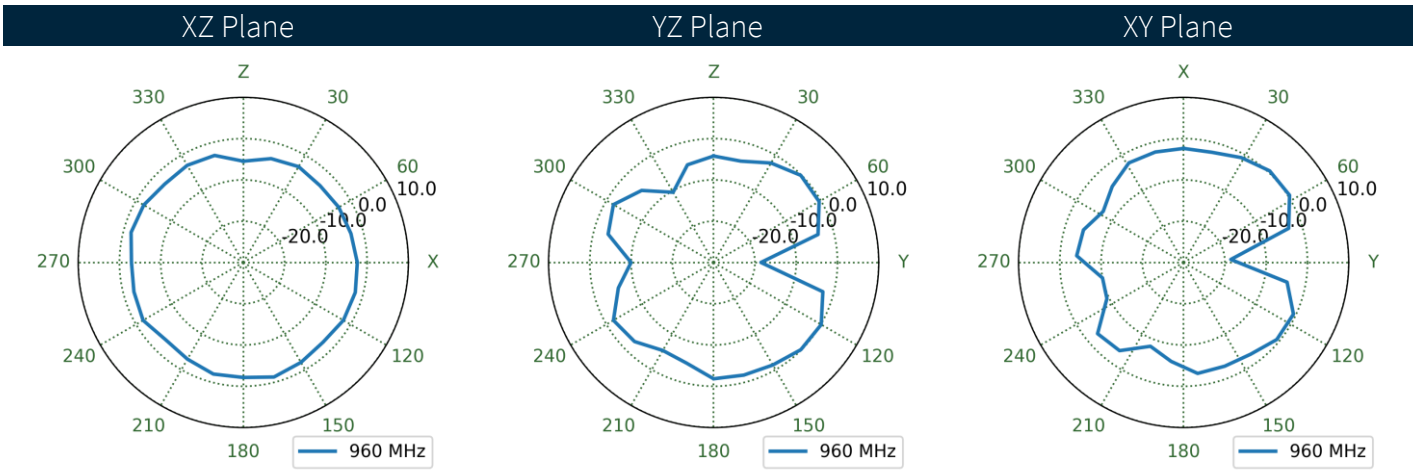
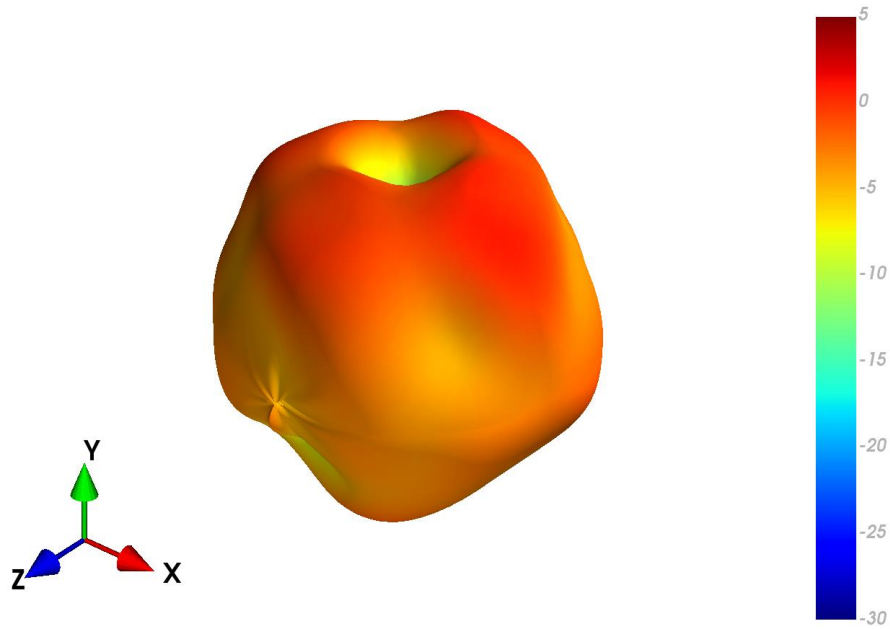

4.24 Straight in Free space - Patterns at 960 MHz

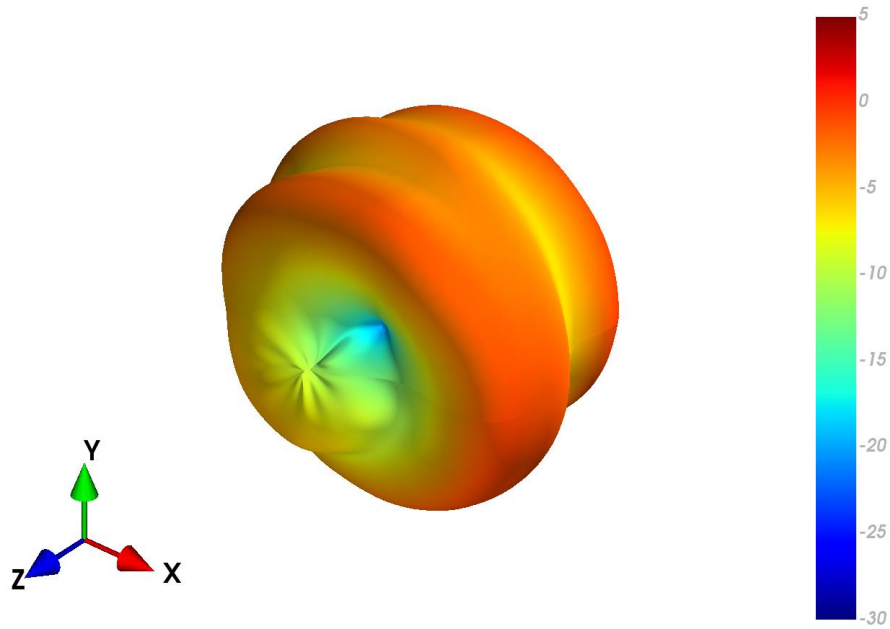

XZ Plane YZ Plane XY Plane

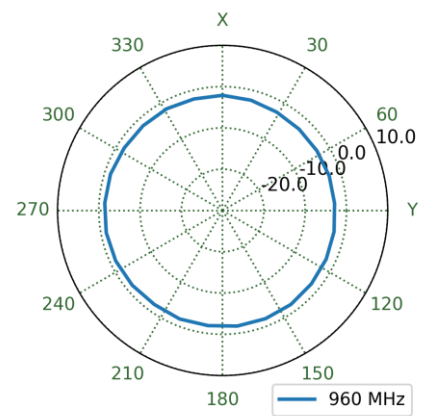
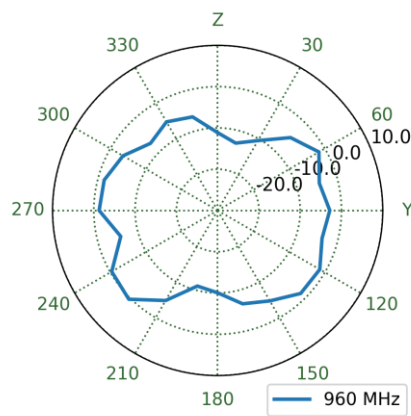
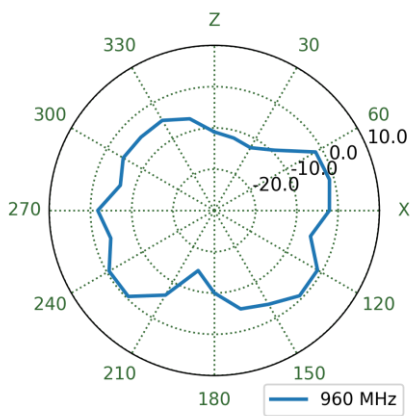

4.25 Straight (Edge) 30x30cm Ground plane - Patterns at 960 MHz

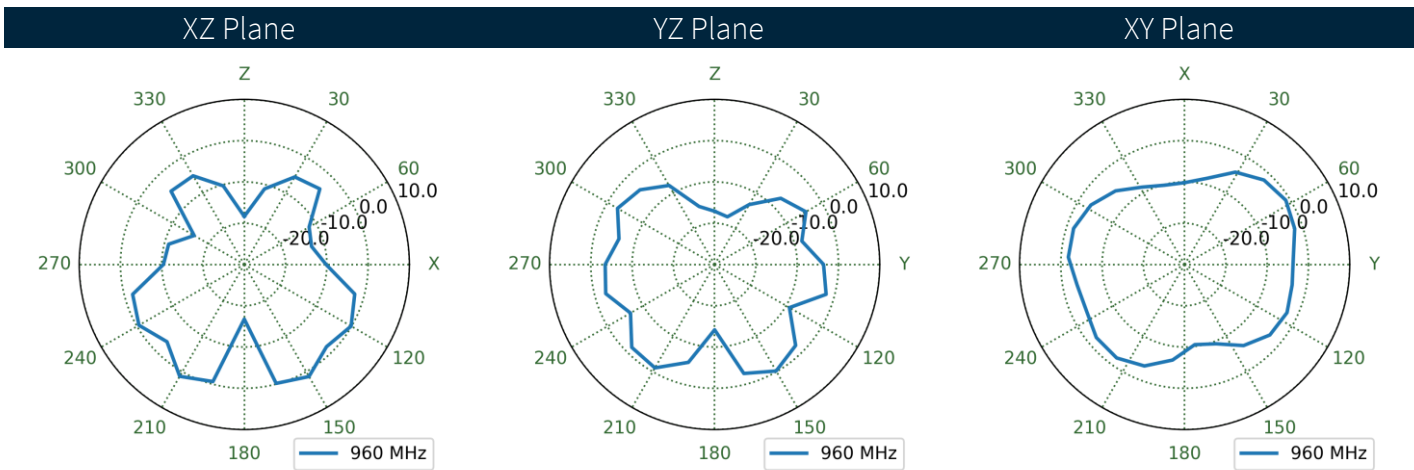
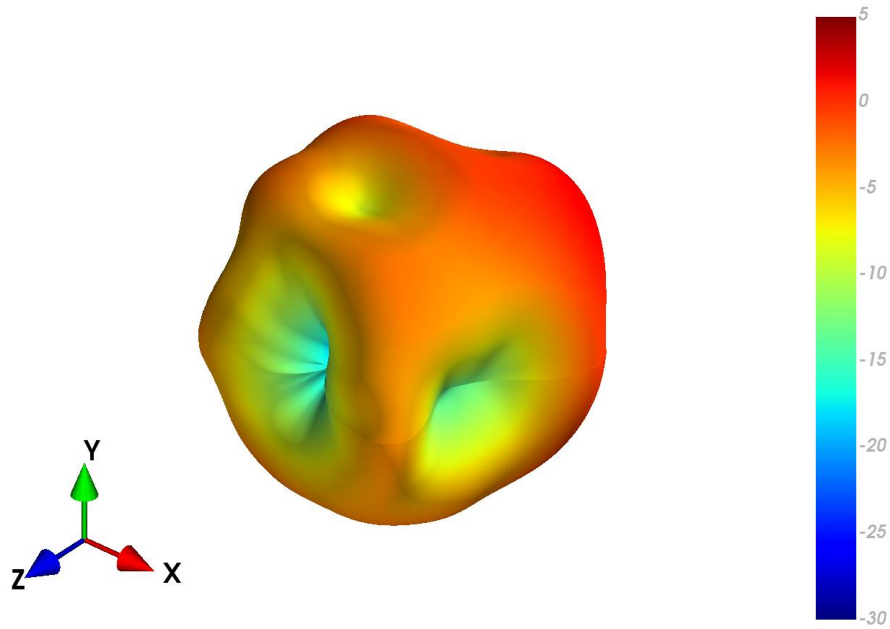

4.26 Bent (Centre) 30x30cm Ground plane - Patterns at 1470 MHz

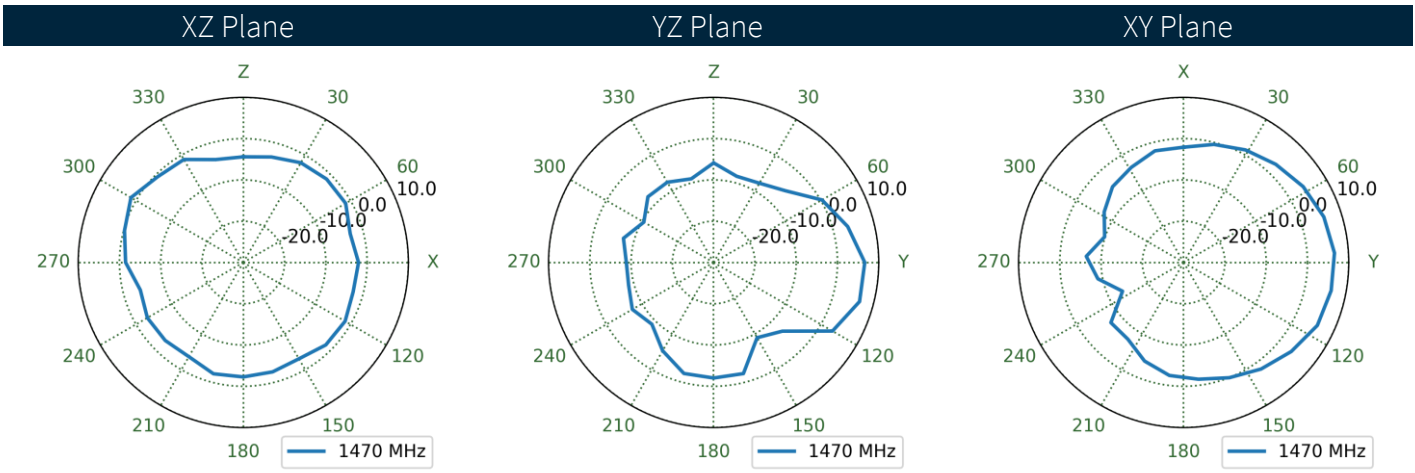
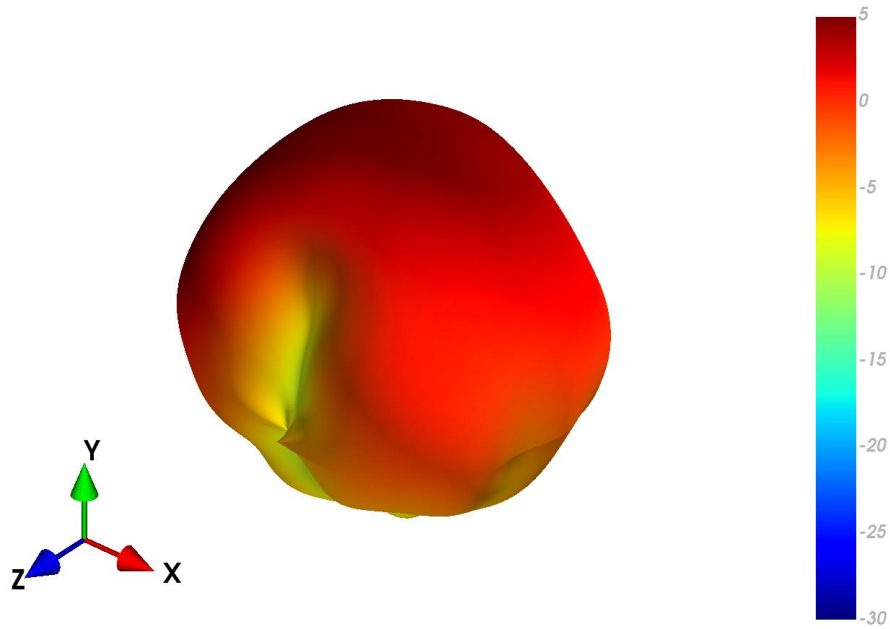

4.27 Bent in Free space - Patterns at 1470 MHz

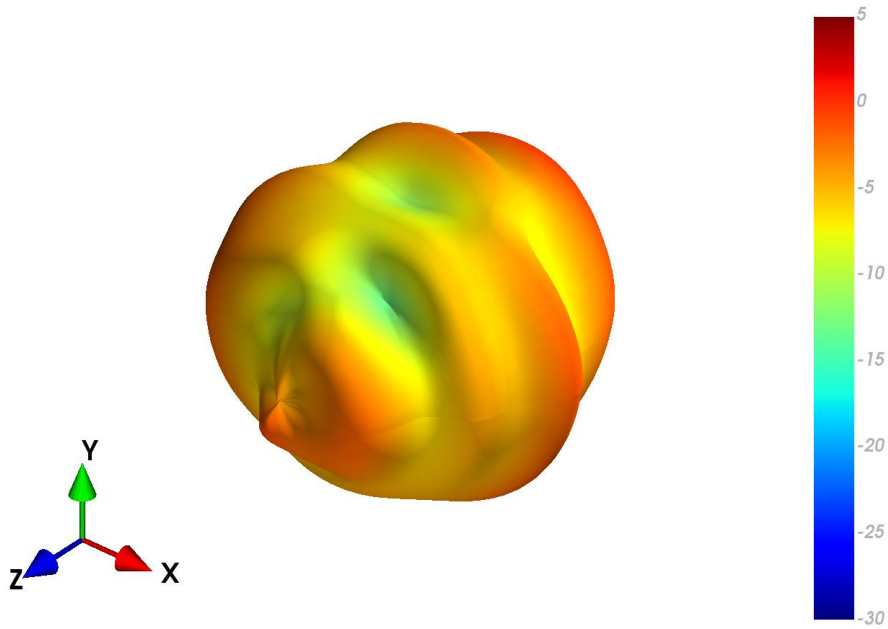

XZ Plane YZ Plane XY Plane

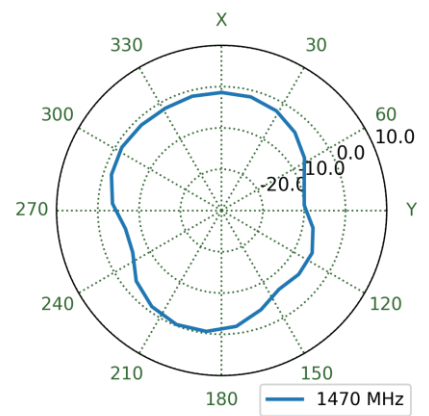
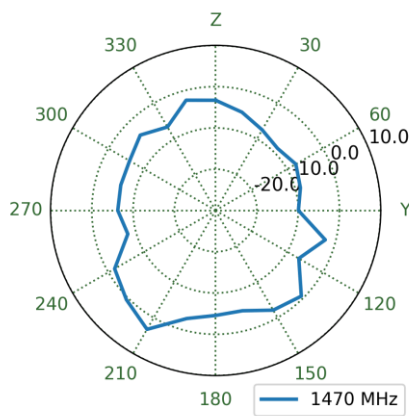
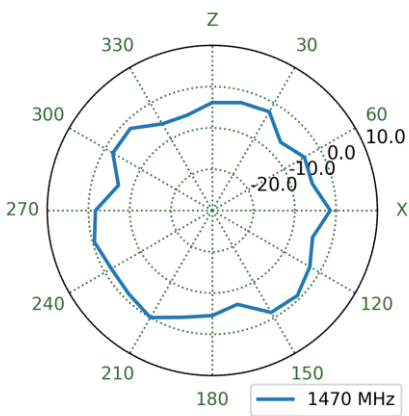

4.28 Bent (Edge) 30x30cm Ground plane - Patterns at 1470 MHz

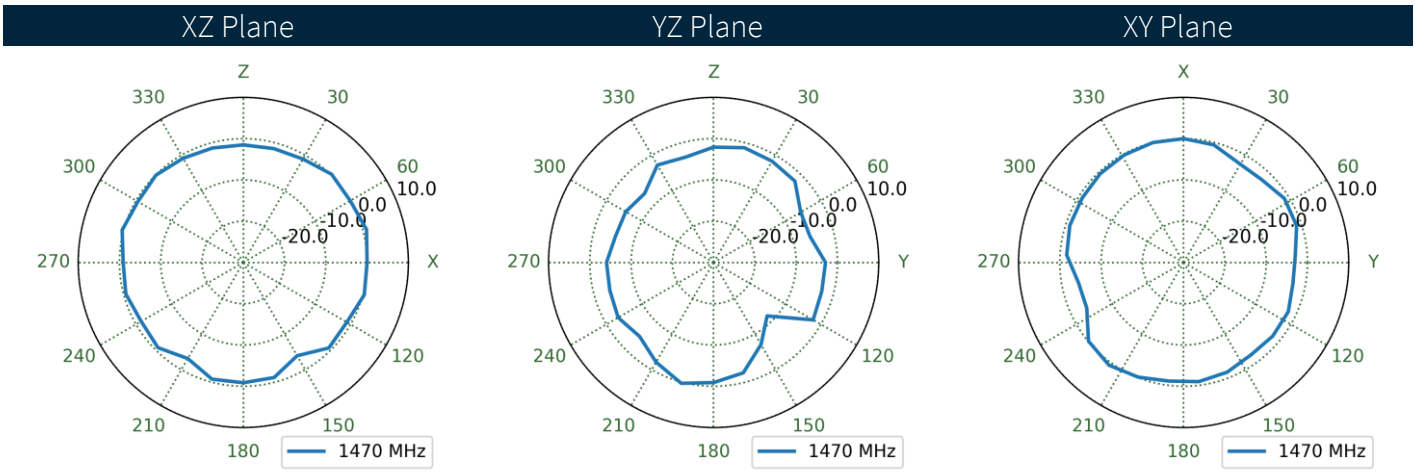
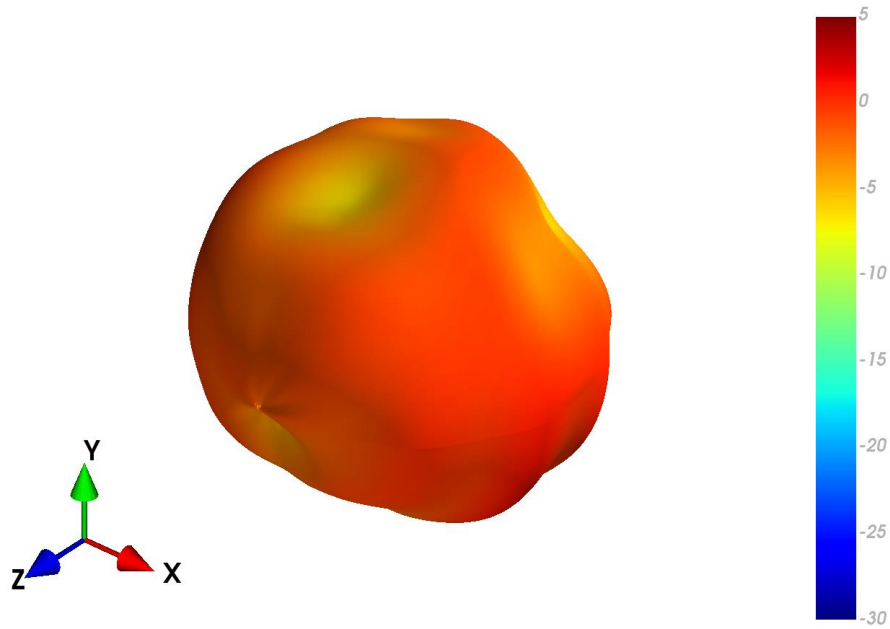

4.29 Straight (Centre) 30x30cm Ground plane - Patterns at 1470 MHz

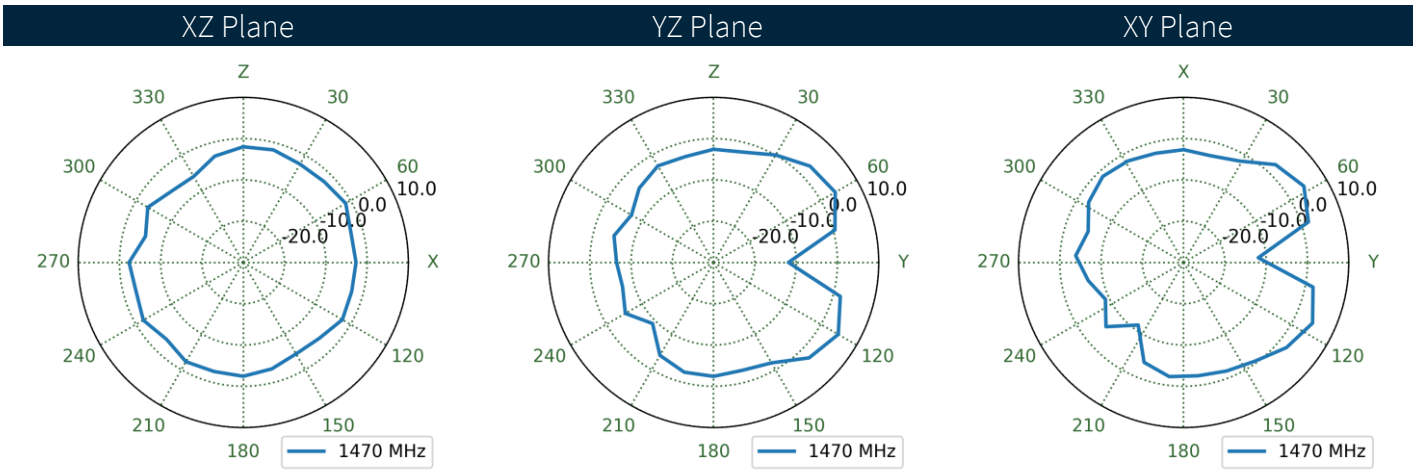
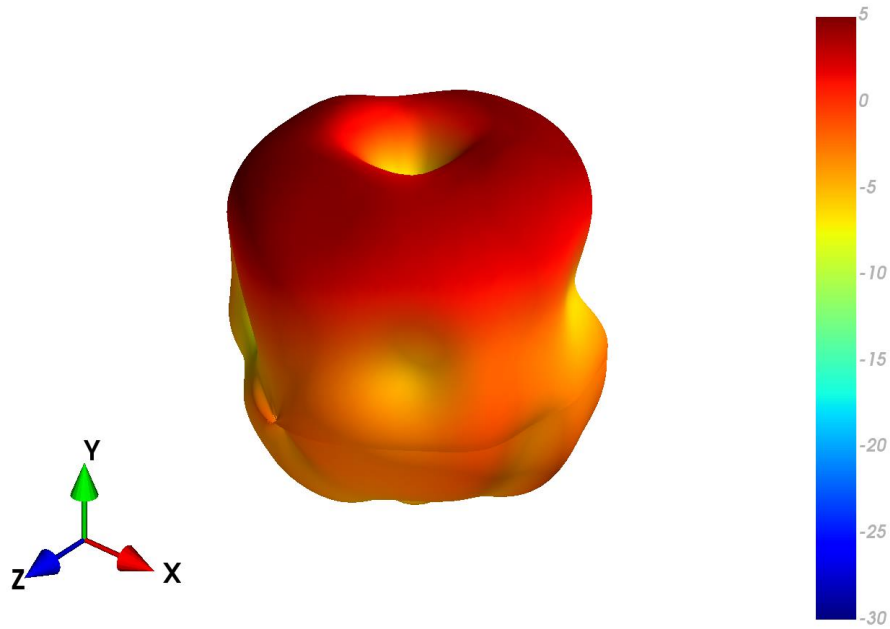

4.30 Straight in Free space - Patterns at 1470 MHz

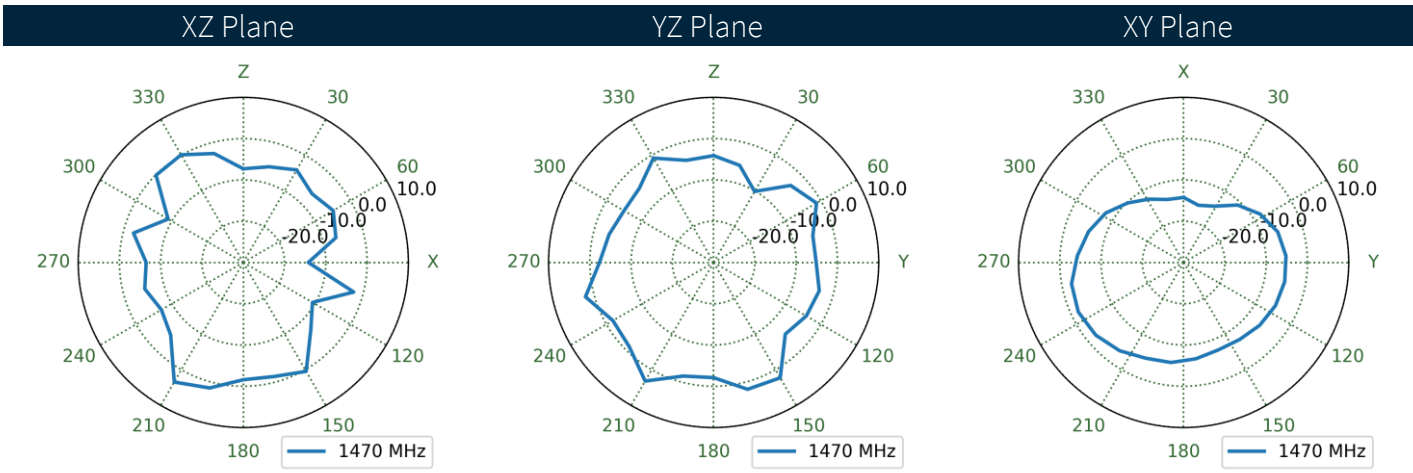
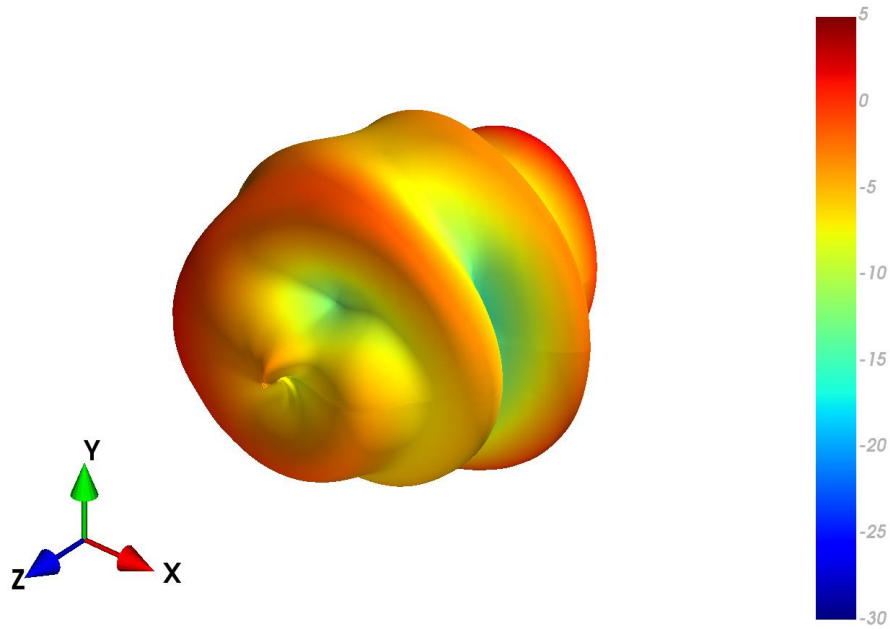

4.31 Straight (Edge) 30x30cm Ground plane - Patterns at 1470 MHz

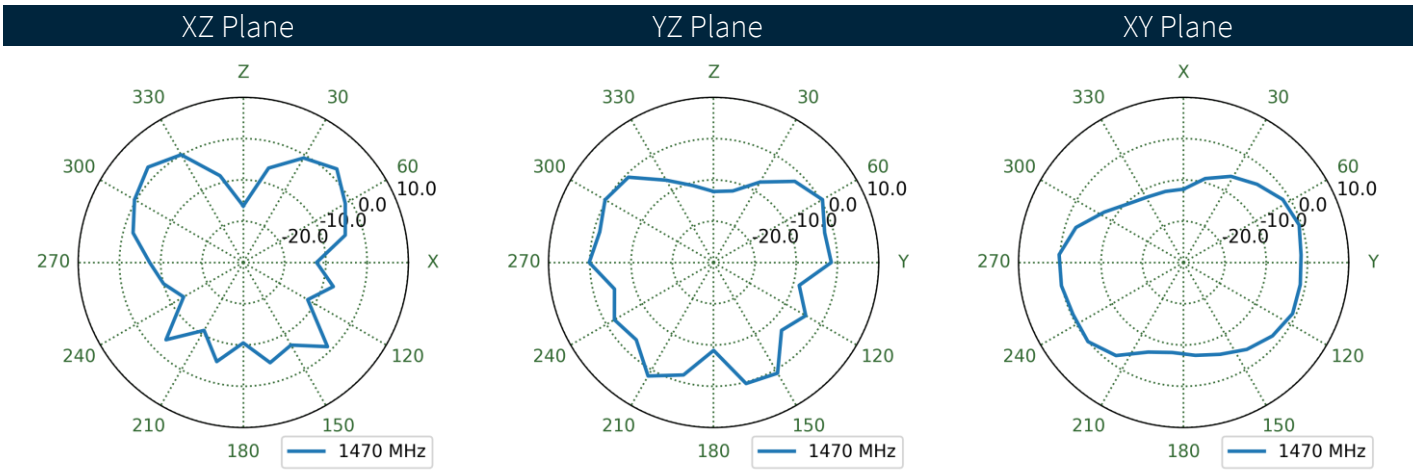
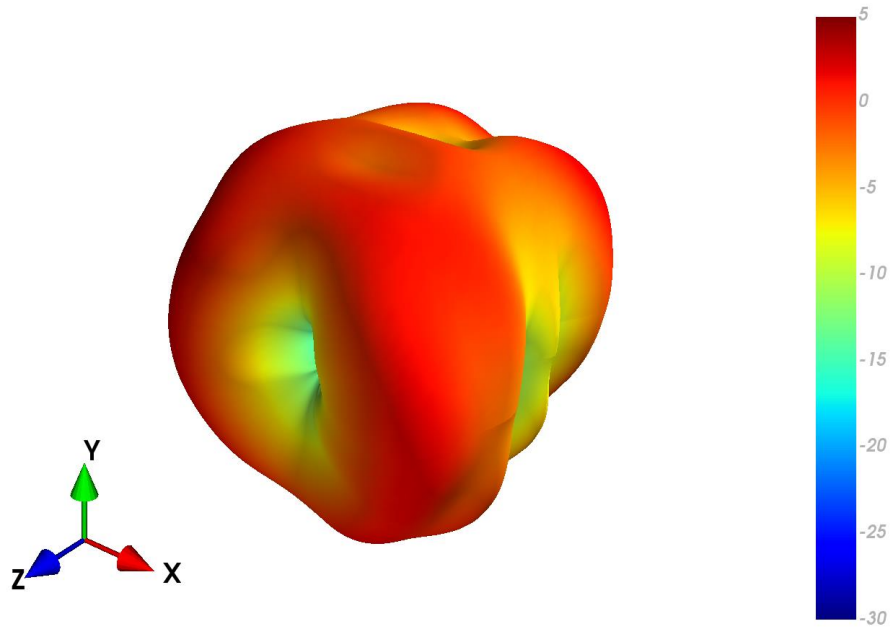

4.32 Bent (Centre) 30x30cm Ground plane - Patterns at 1805 MHz

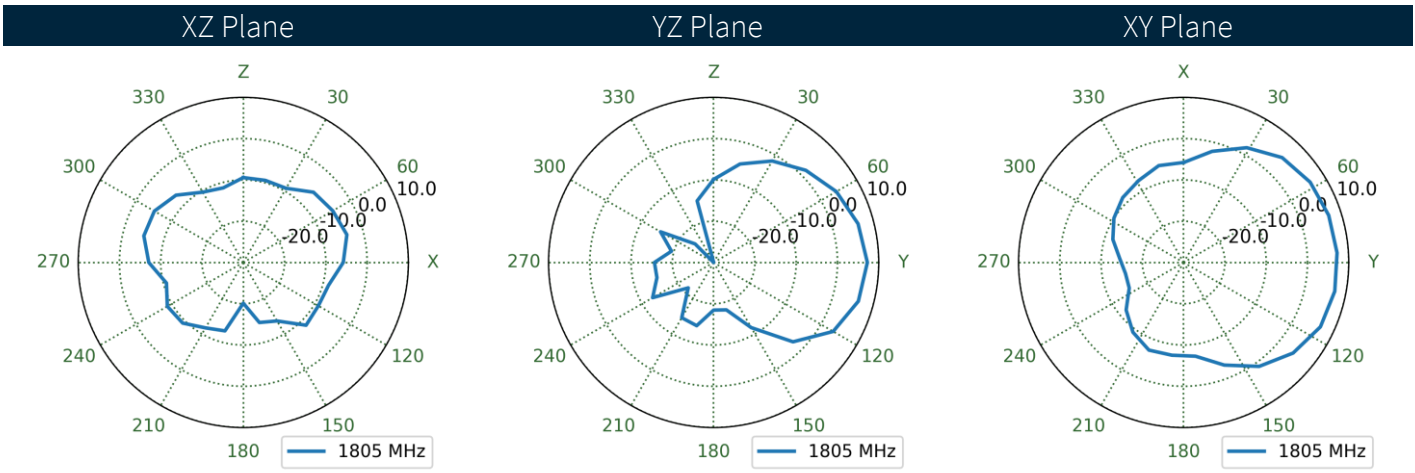
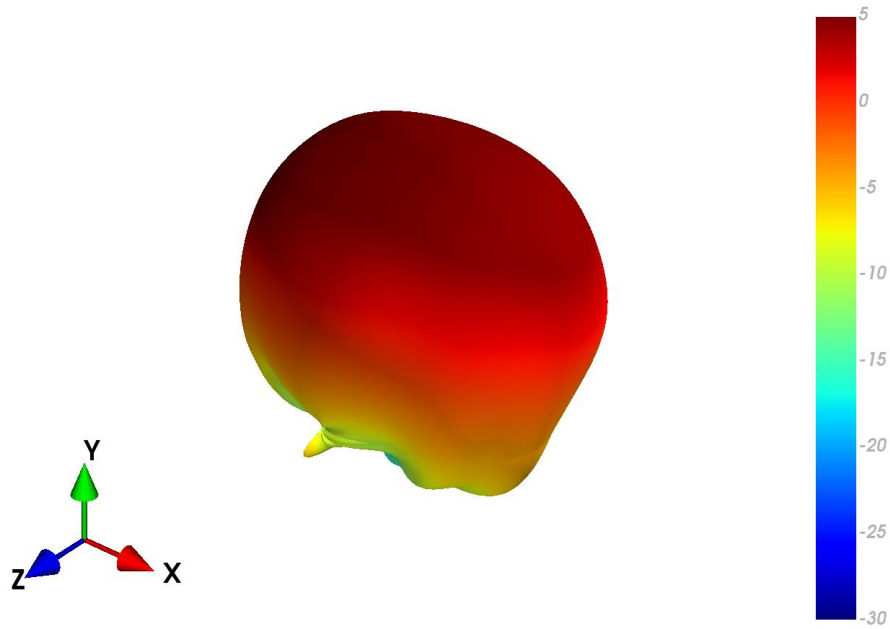

4.33 Bent in Free space - Patterns at 1805 MHz

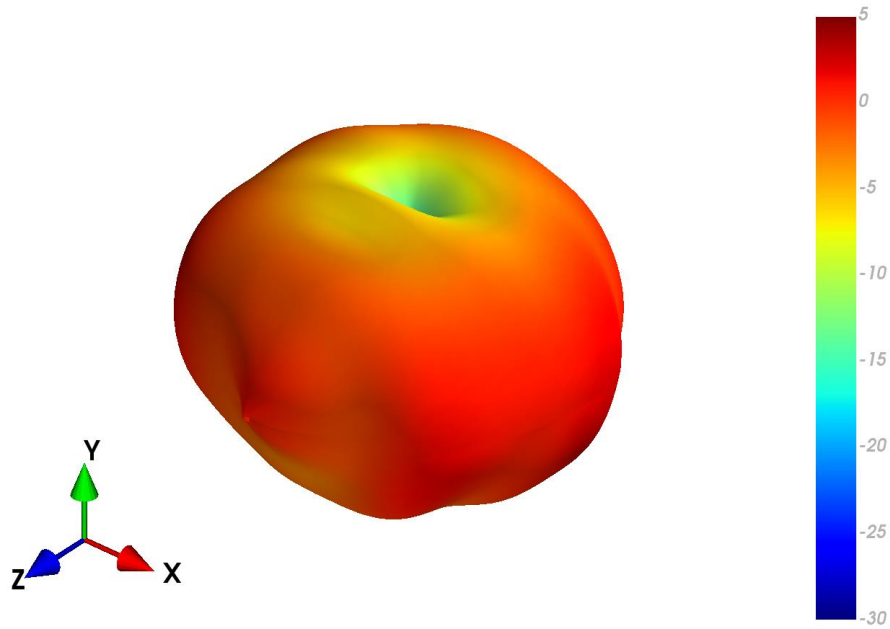

XZ Plane YZ Plane XY Plane

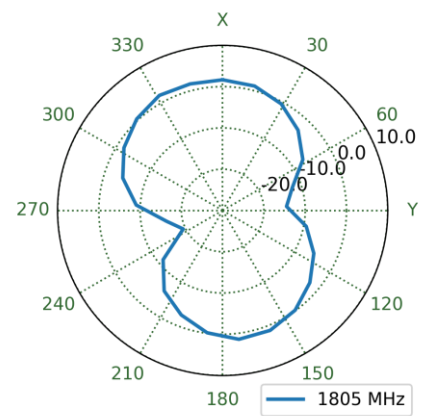
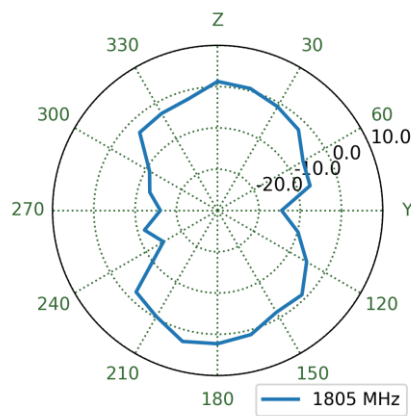
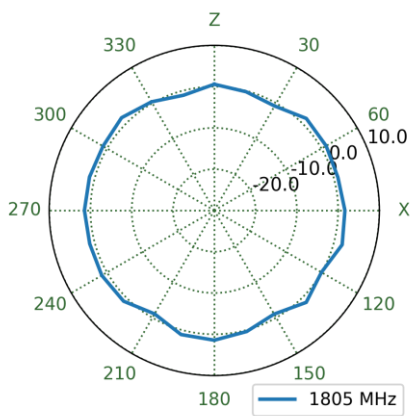

4.34 Bent (Edge) 30x30cm Ground plane - Patterns at 1805 MHz

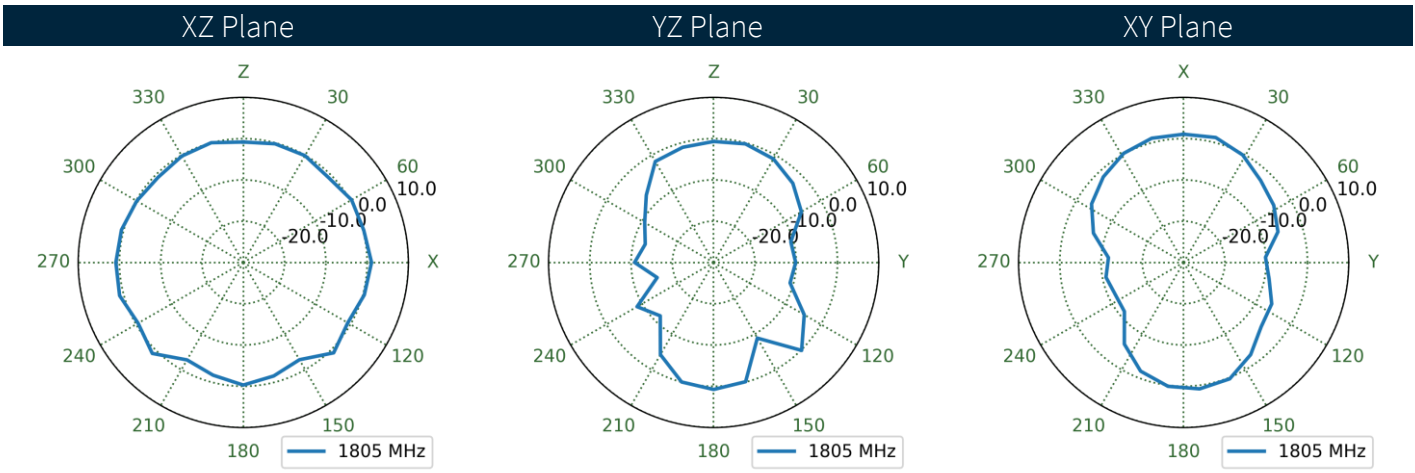
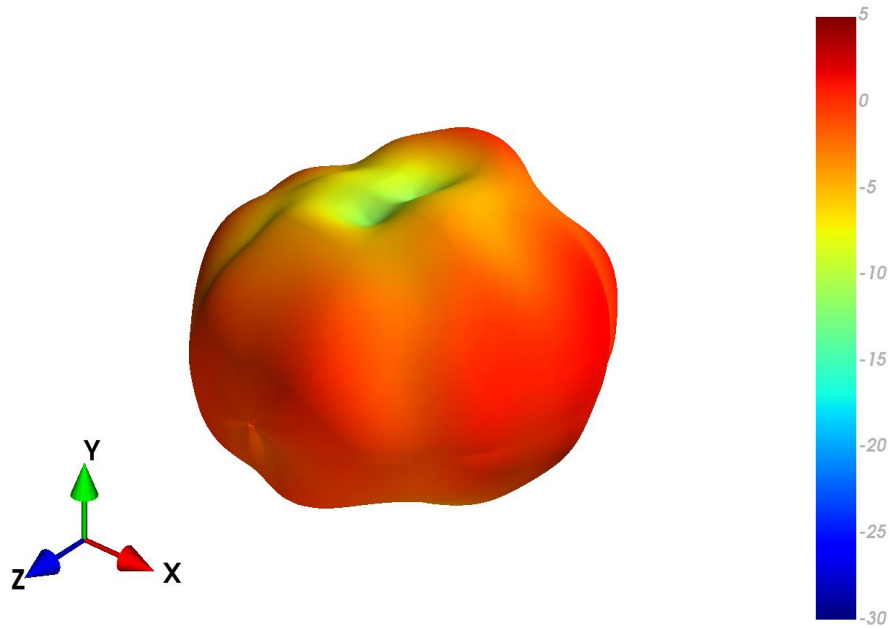

4.35 Straight (Centre) 30x30cm Ground plane - Patterns at 1805 MHz

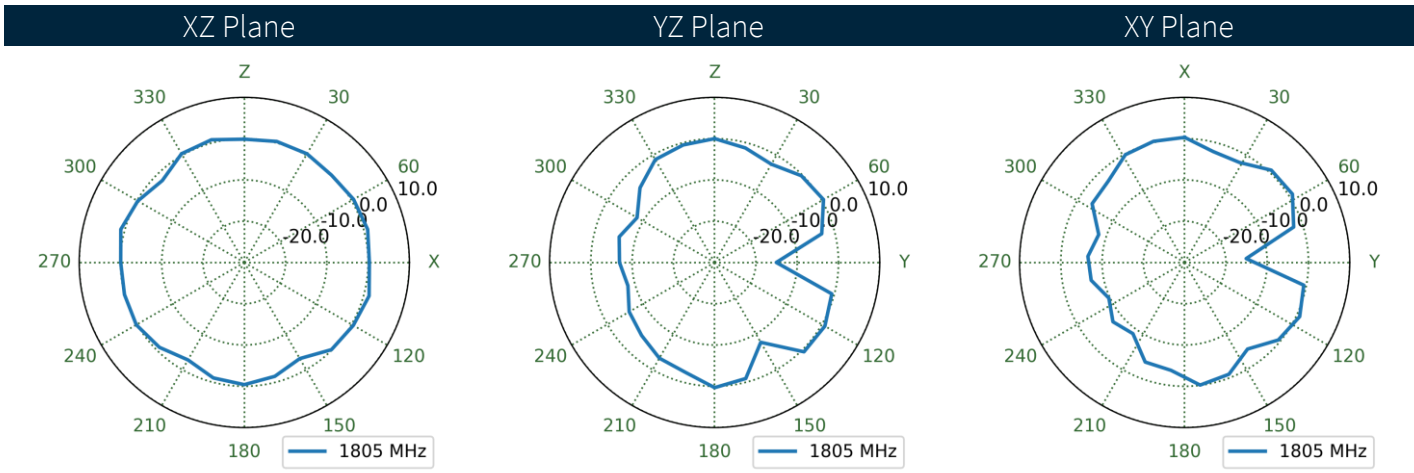
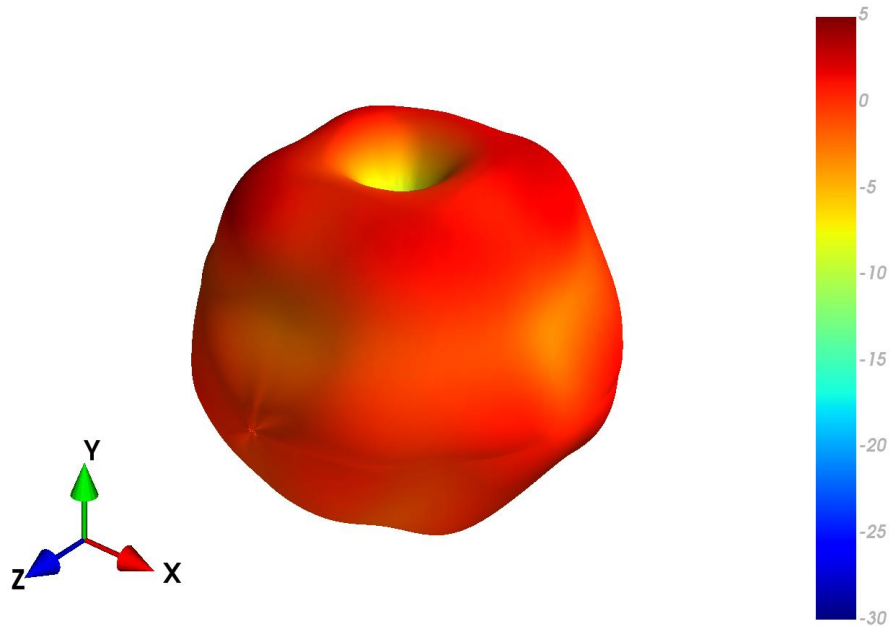

4.36 Straight in Free space - Patterns at 1805 MHz

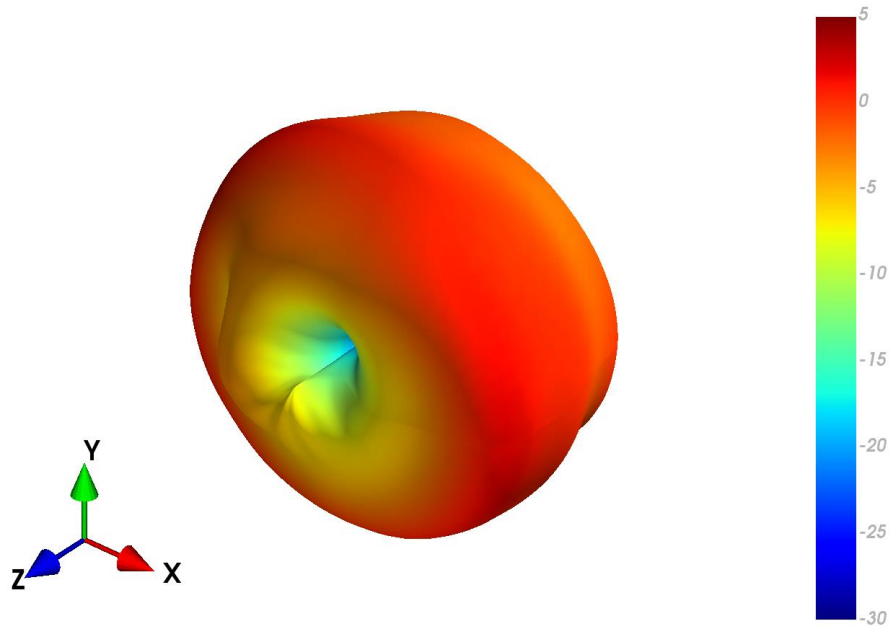

XZ Plane YZ Plane XY Plane

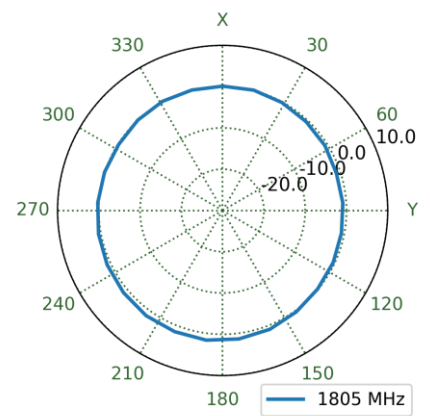
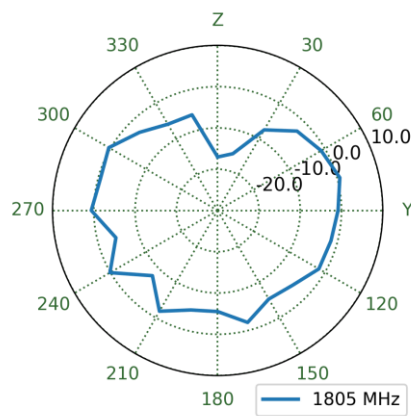
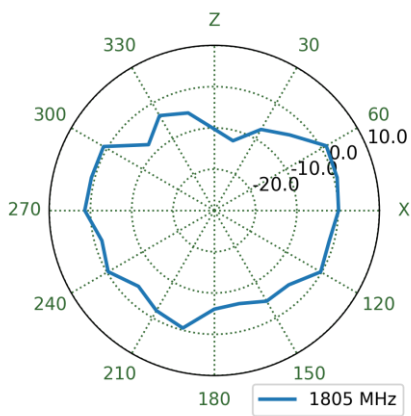

4.37 Straight (Edge) 30x30cm Ground plane - Patterns at 1805 MHz

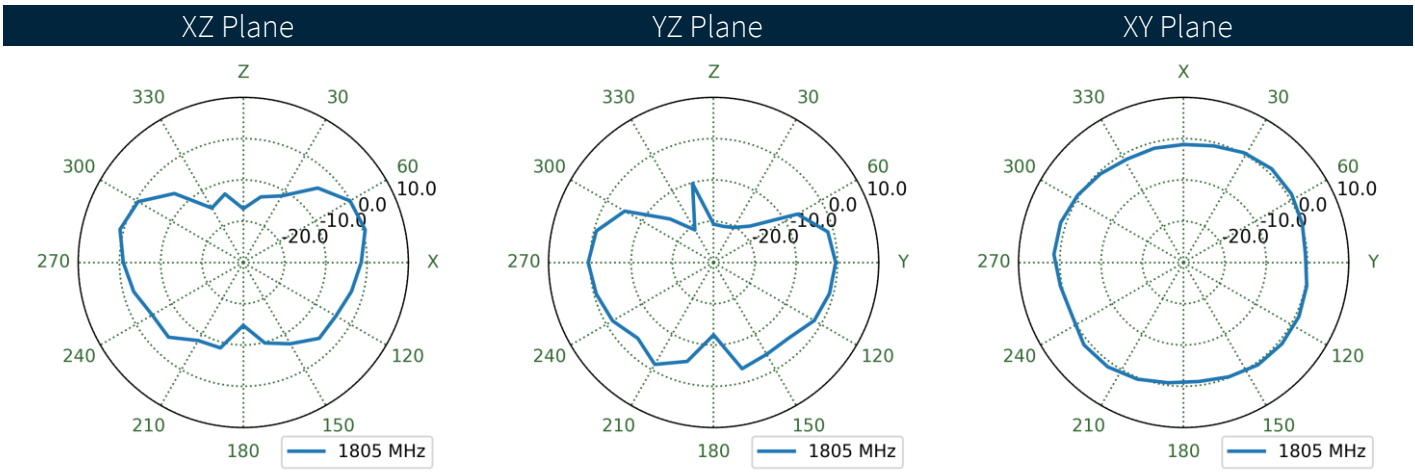
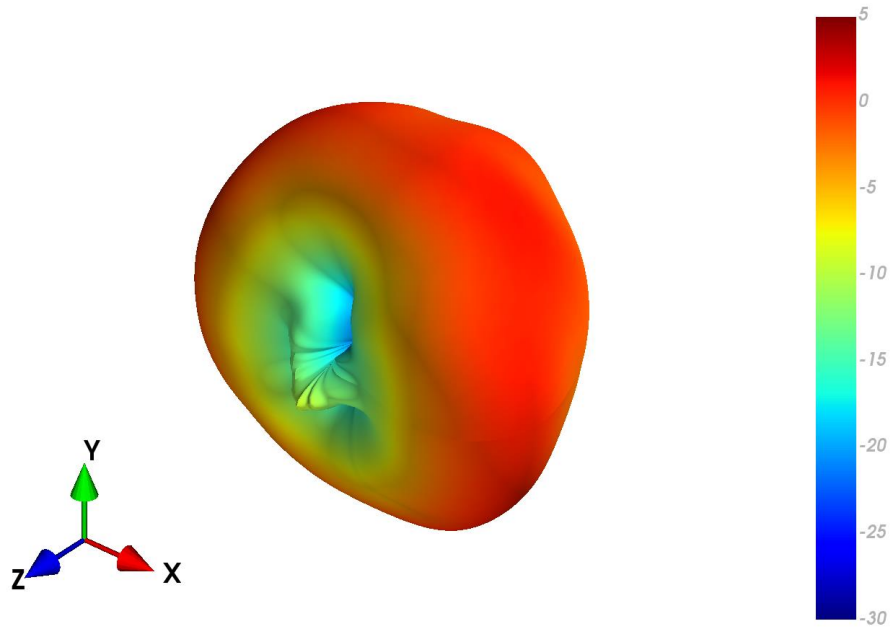

4.38 Bent (Centre) 30x30cm Ground plane - Patterns at 1920 MHz

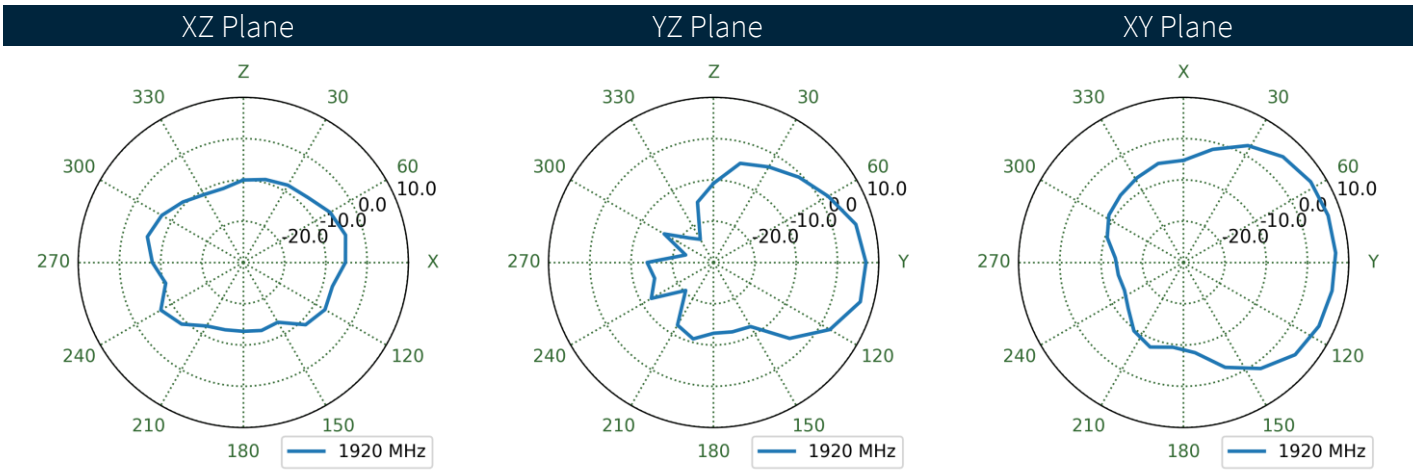
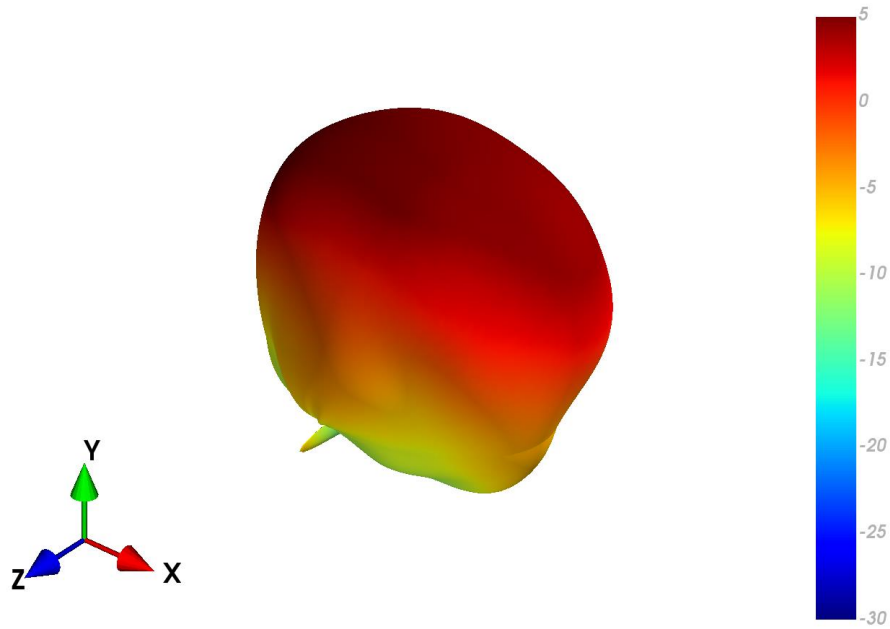

4.39 Bent in Free space - Patterns at 1920 MHz

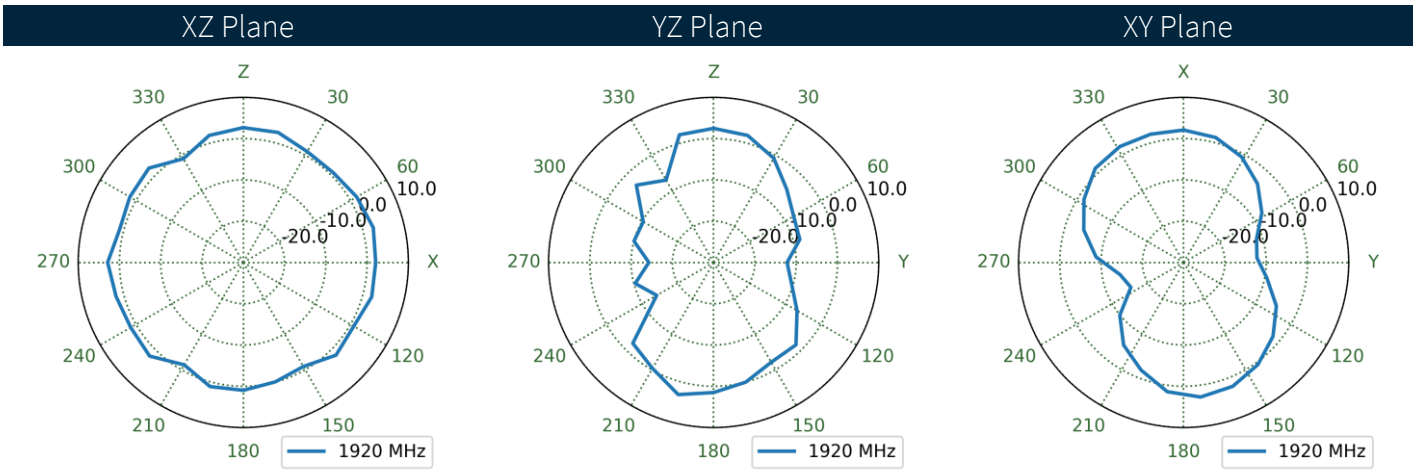
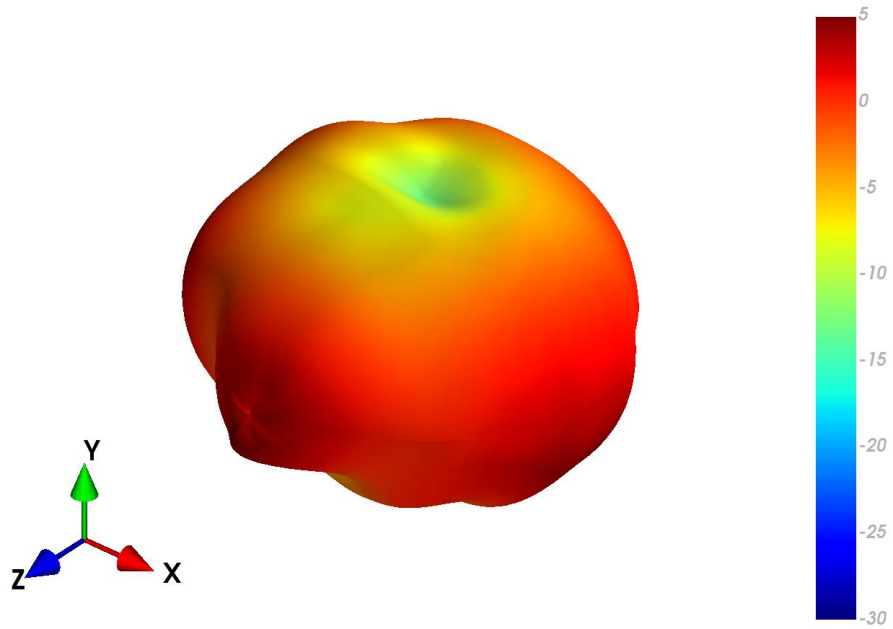

4.40 Bent (Edge) 30x30cm Ground plane - Patterns at 1920 MHz

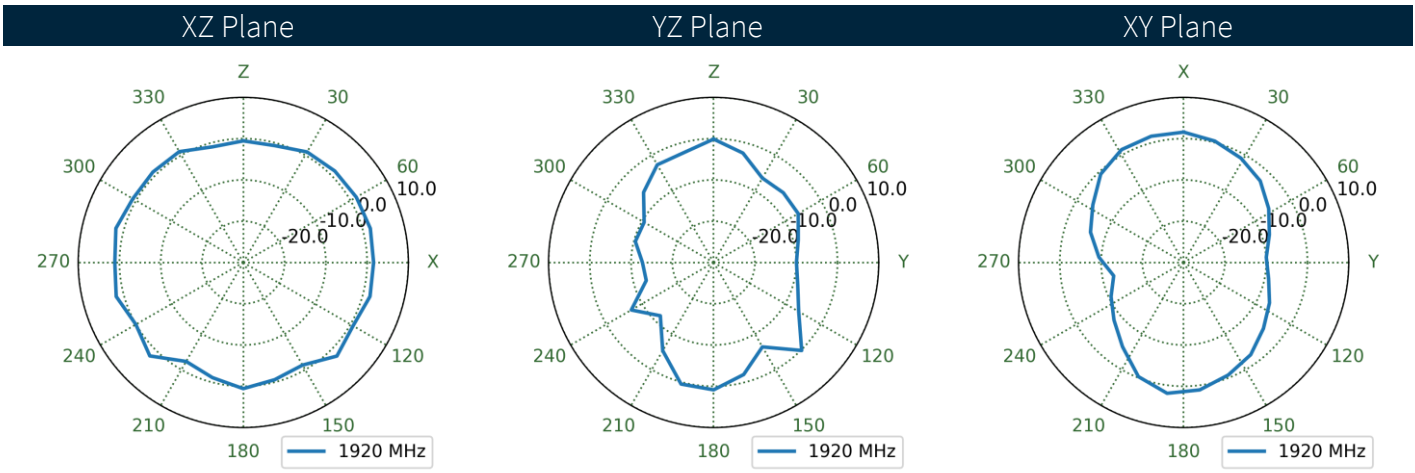
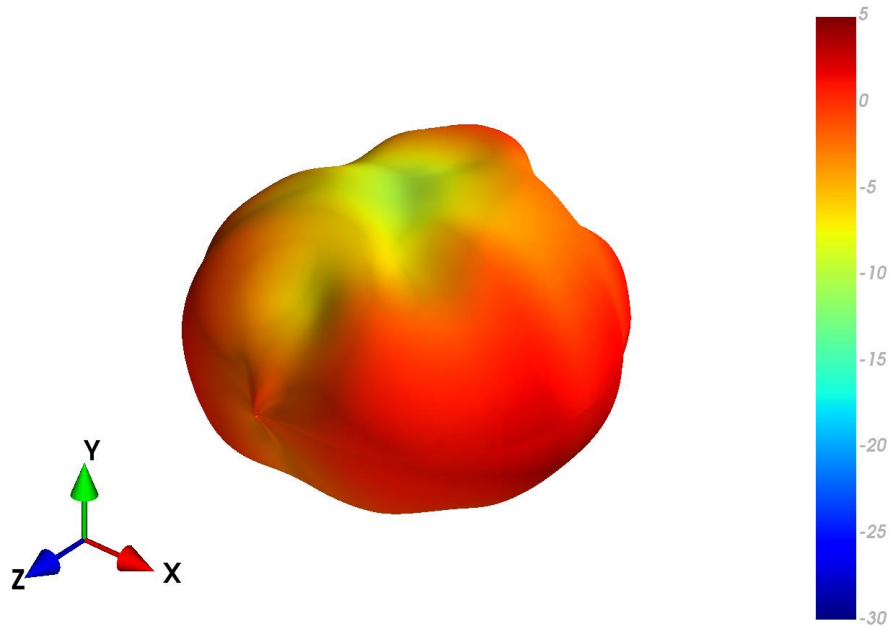

4.41 Straight (Centre) 30x30cm Ground plane - Patterns at 1920 MHz

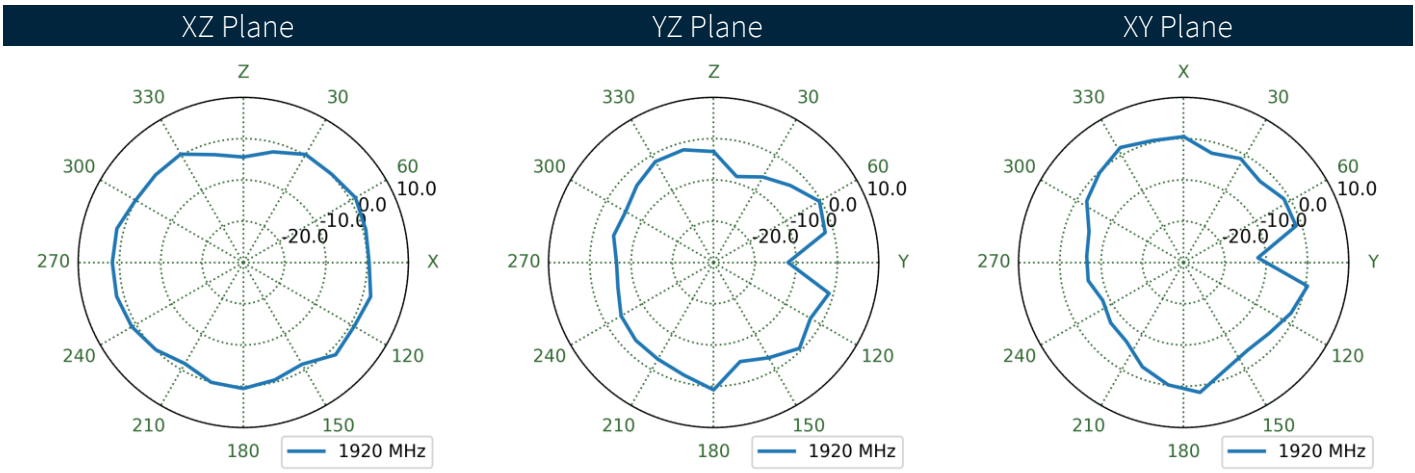
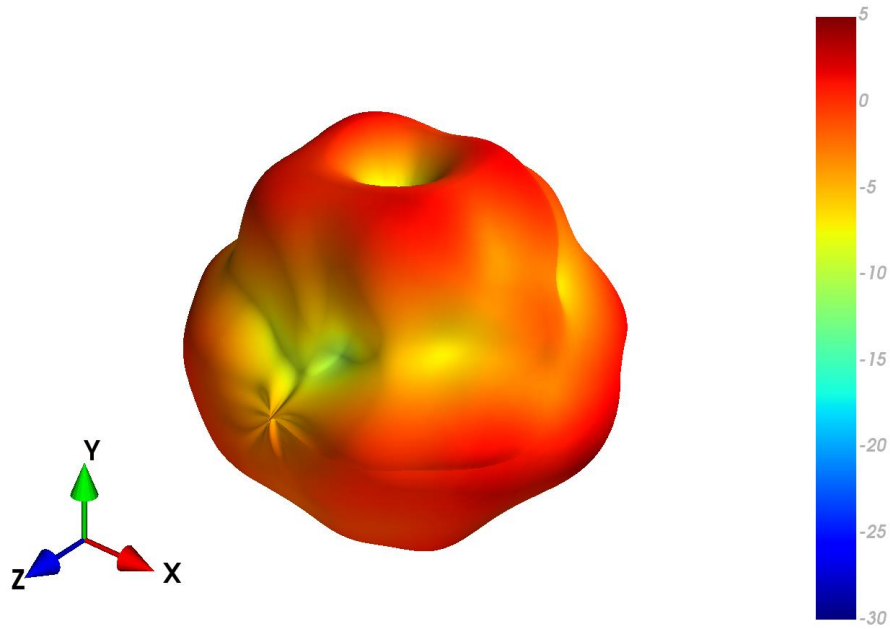

4.42 Straight in Free space - Patterns at 1920 MHz

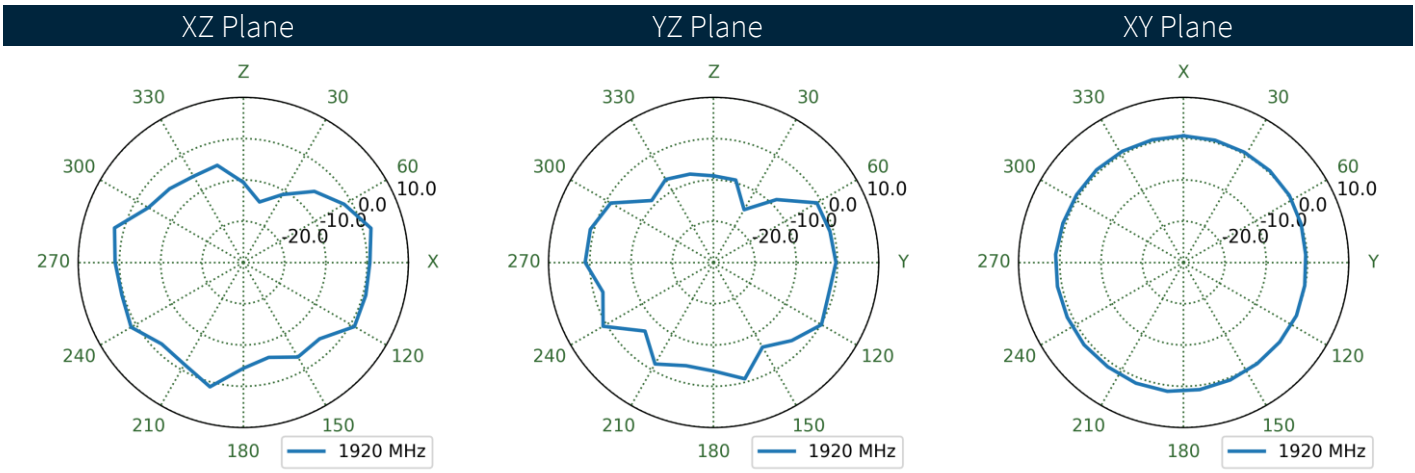
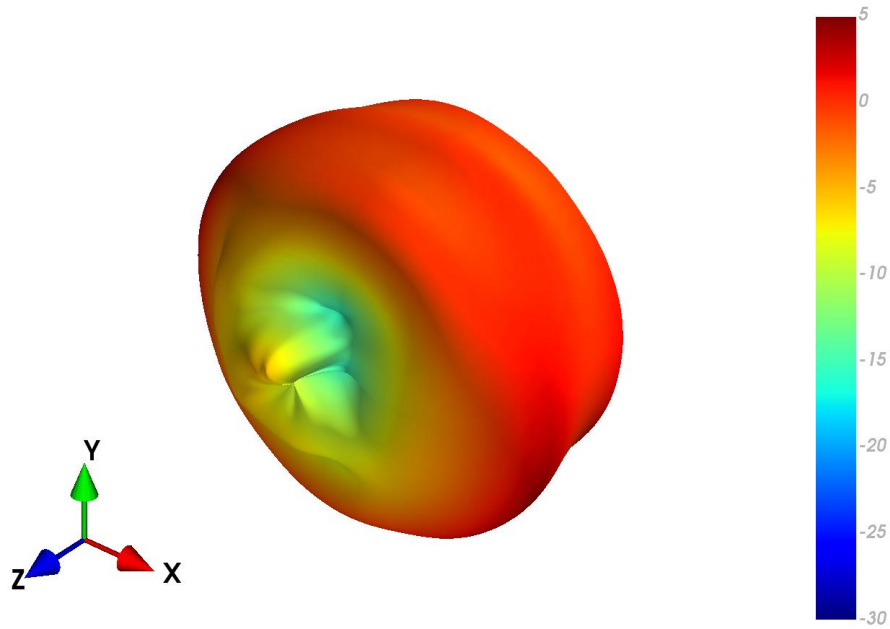

4.43 Straight (Edge) 30x30cm Ground plane - Patterns at 1920 MHz

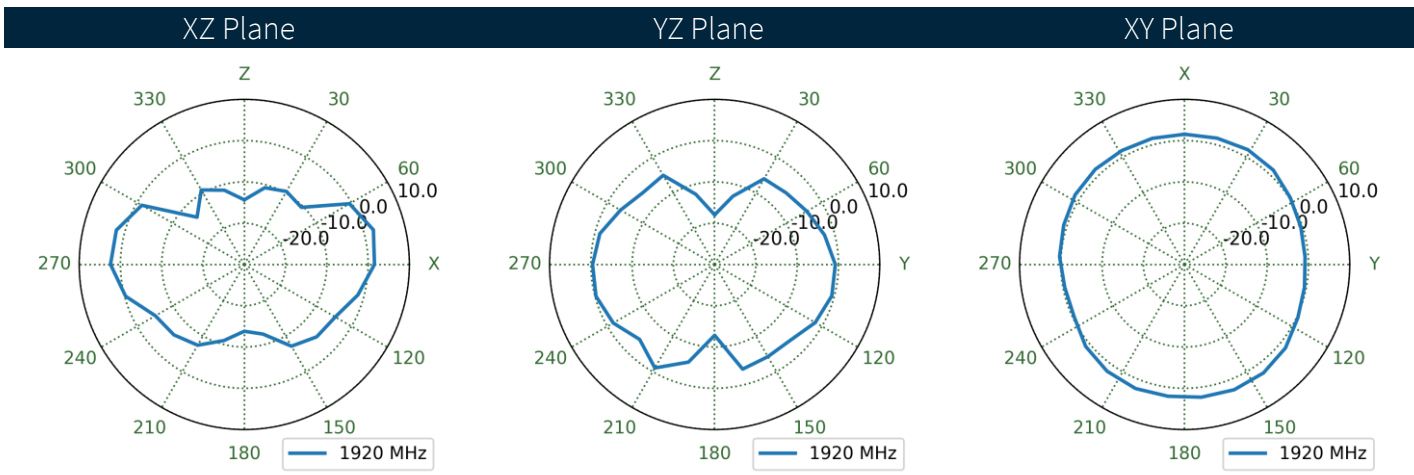
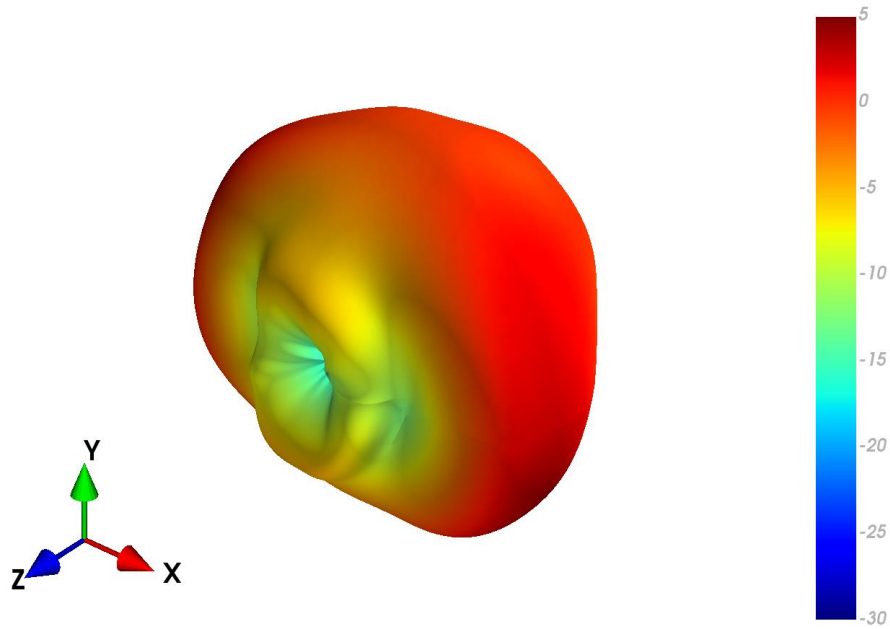

4.44 Bent (Centre) 30x30cm Ground plane - Patterns at 2595 MHz

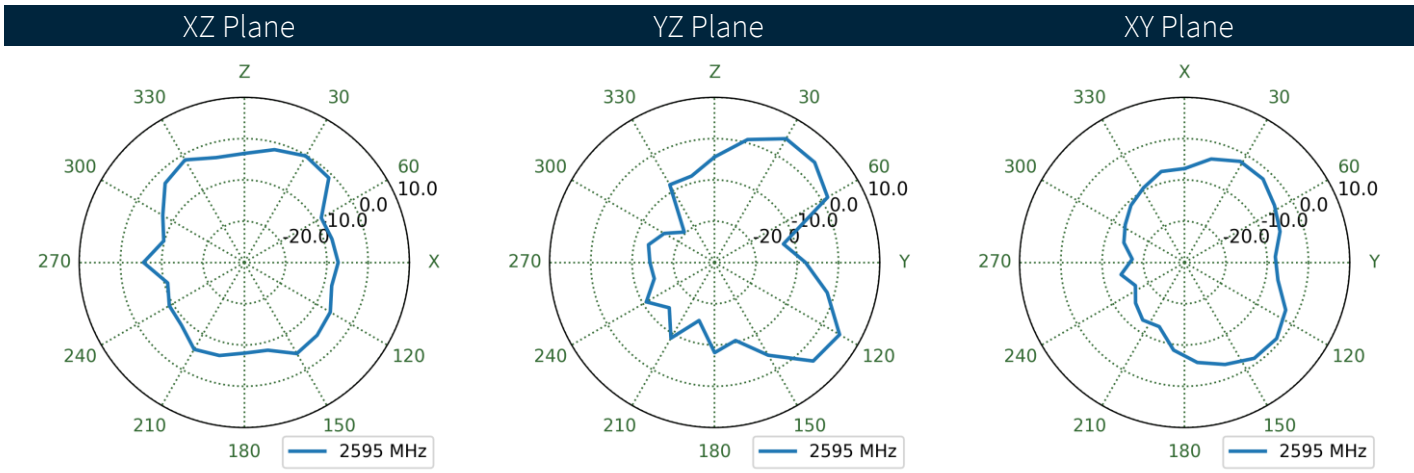
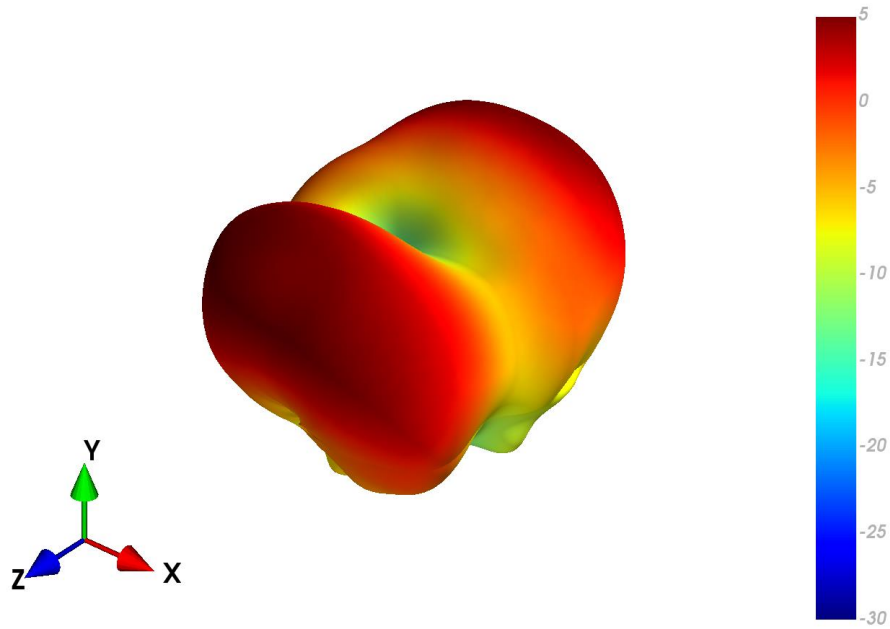

4.45 Bent in Free space - Patterns at 2595 MHz

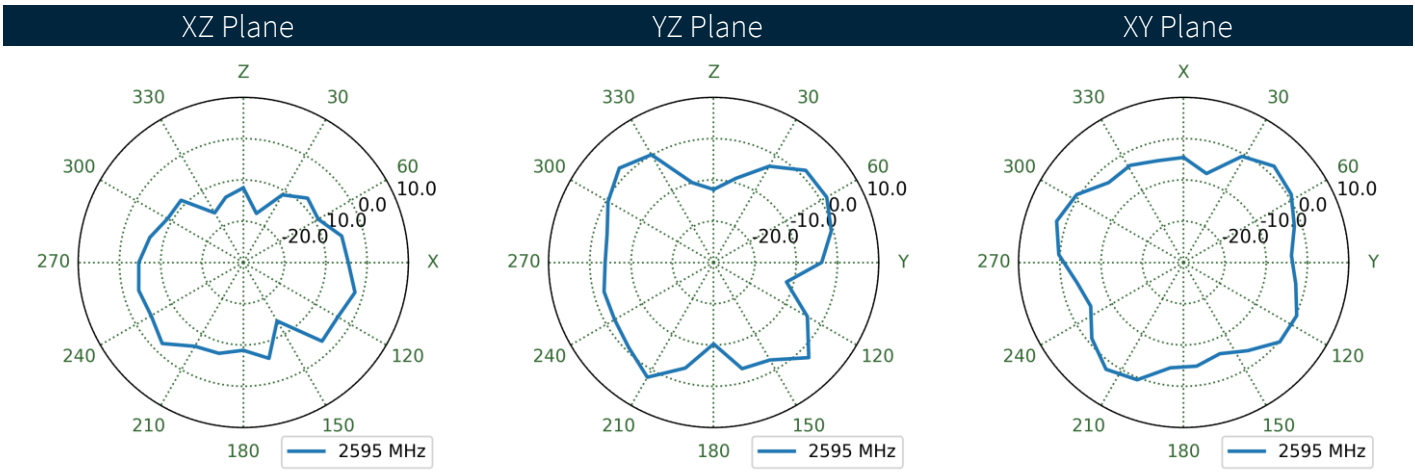
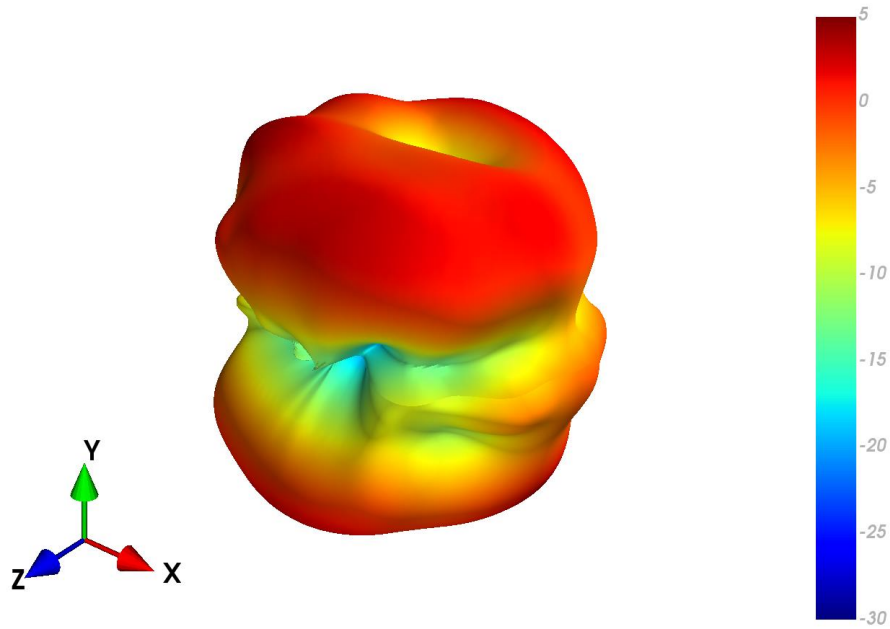

4.46 Bent (Edge) 30x30cm Ground plane - Patterns at 2595 MHz

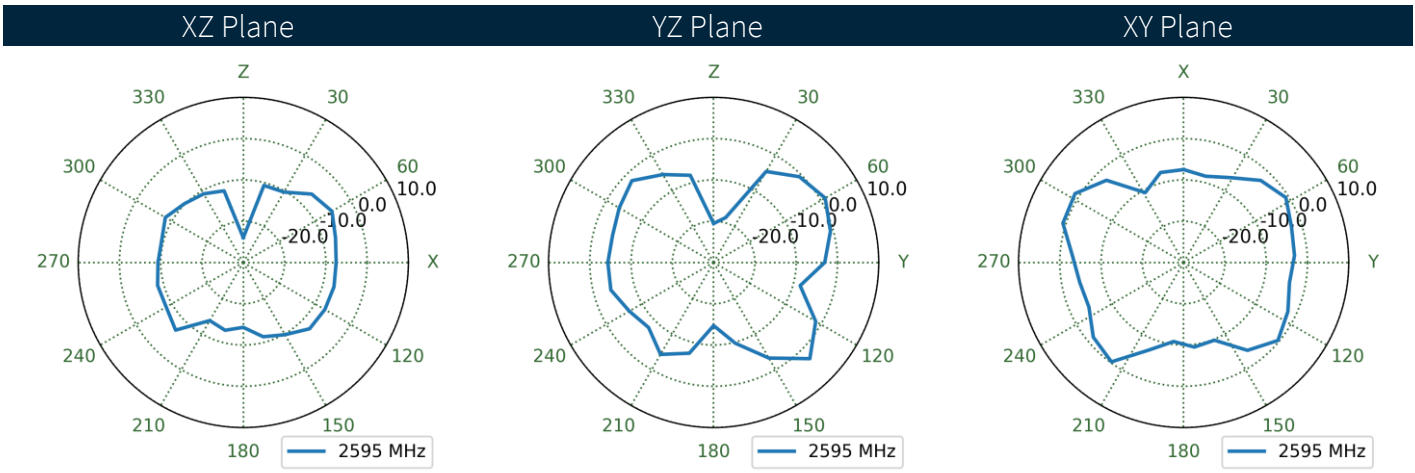
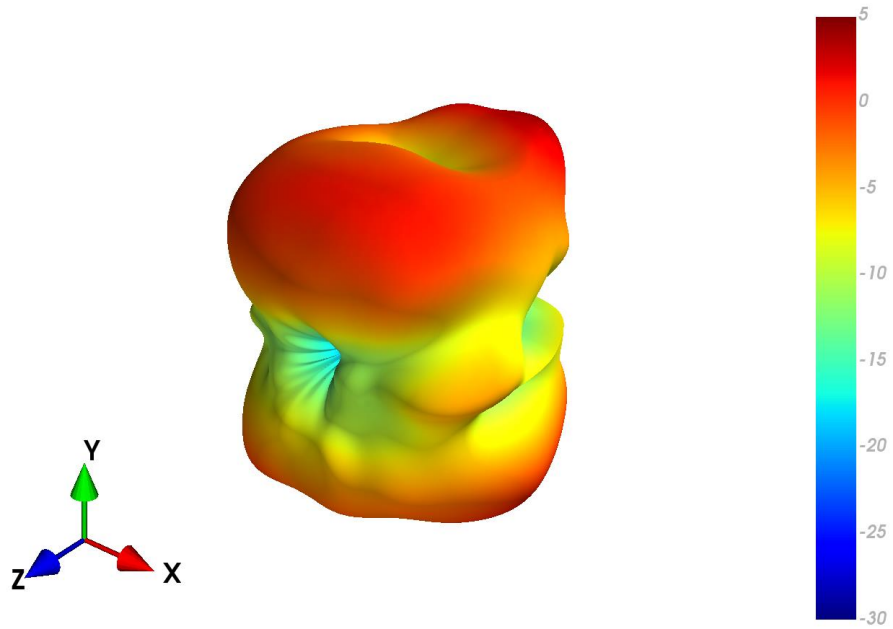

4.47 Straight (Centre) 30x30cm Ground plane - Patterns at 2595 MHz

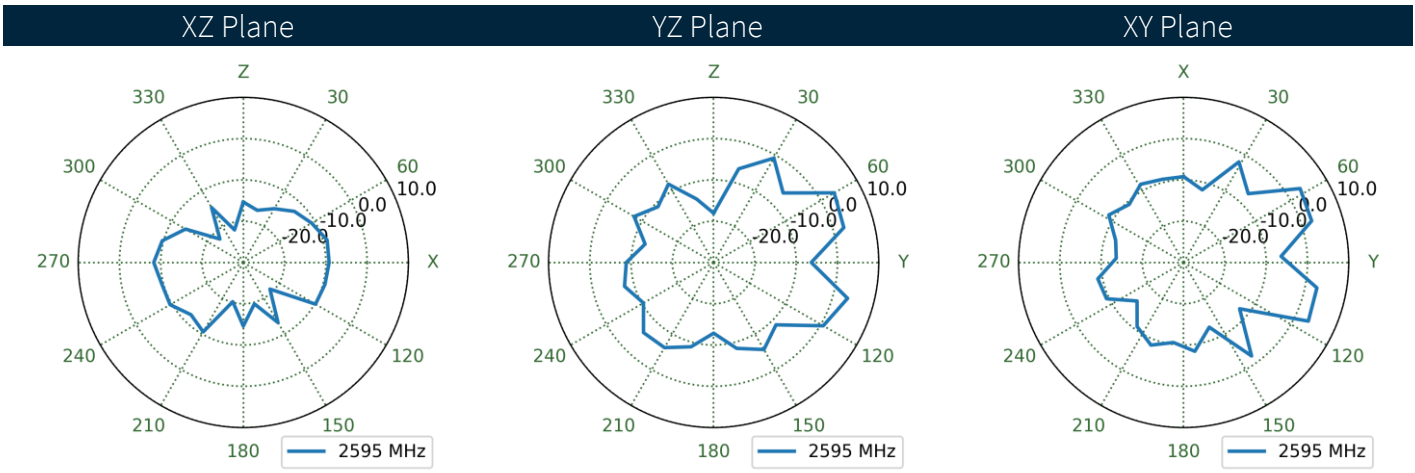
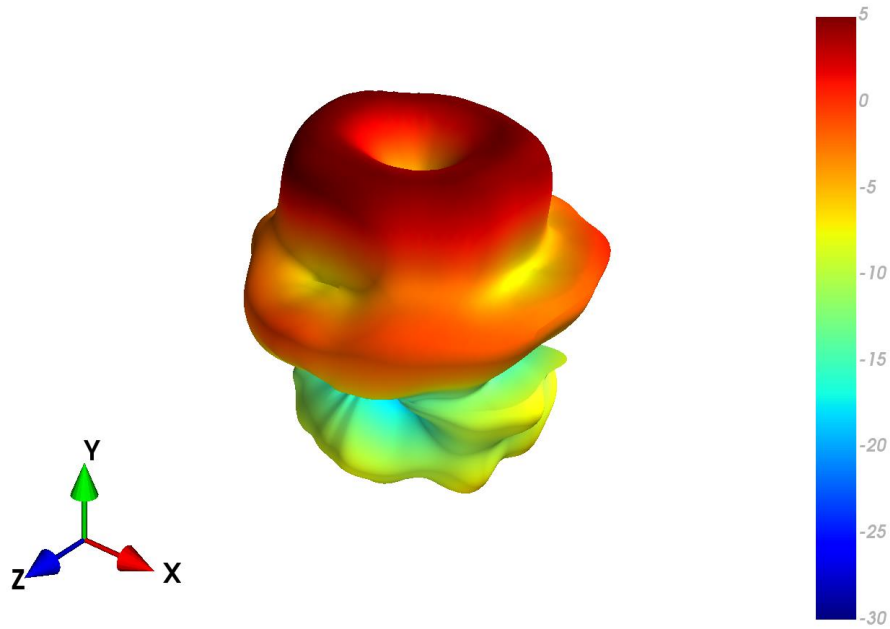

4.48 Straight in Free space - Patterns at 2595 MHz

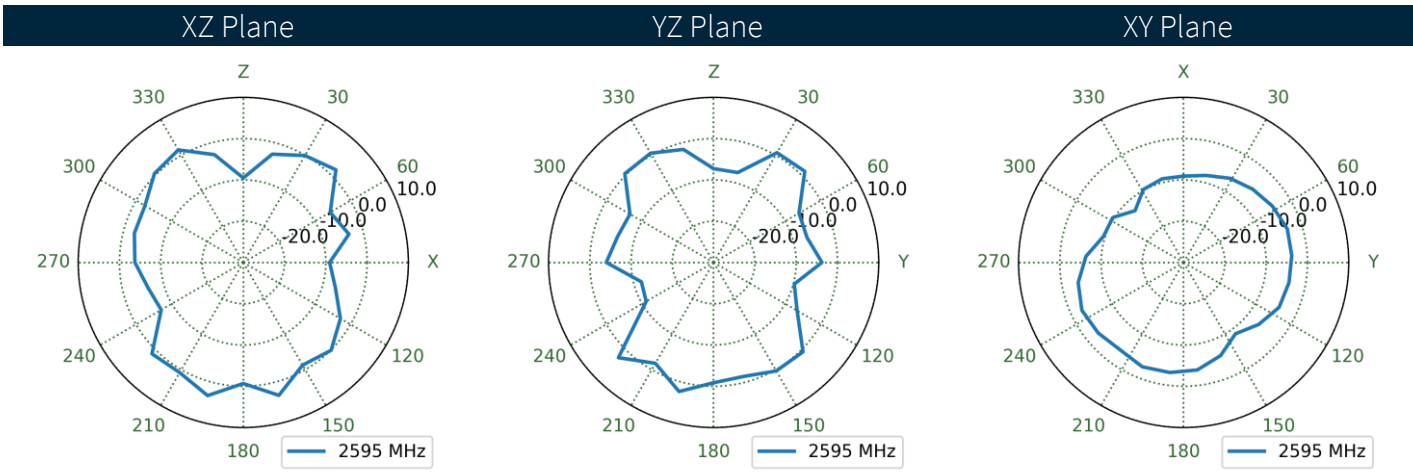
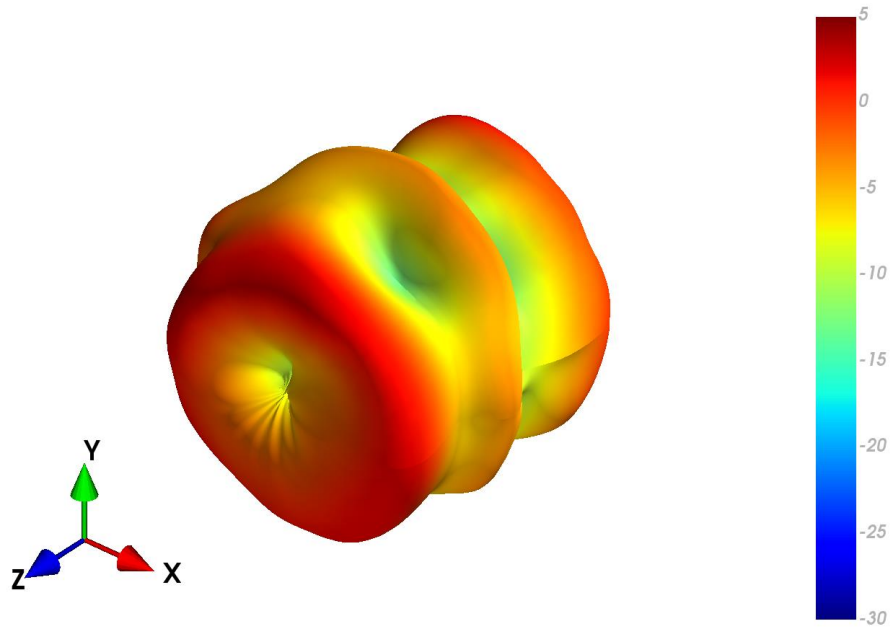

4.49 Straight (Edge) 30x30cm Ground plane - Patterns at 2595 MHz

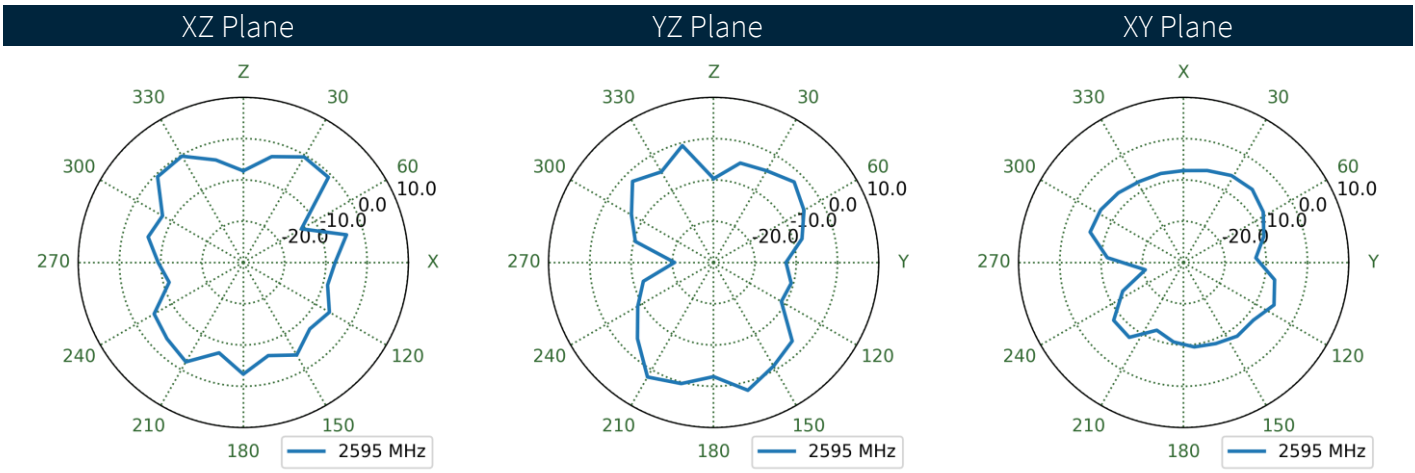
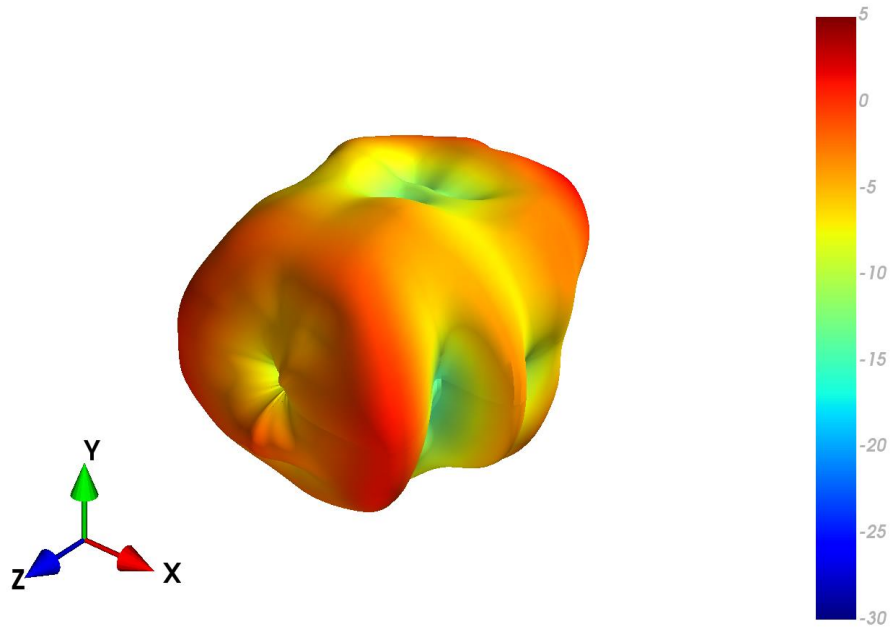

4.50 Bent (Centre) 30x30cm Ground plane - Patterns at 3500 MHz

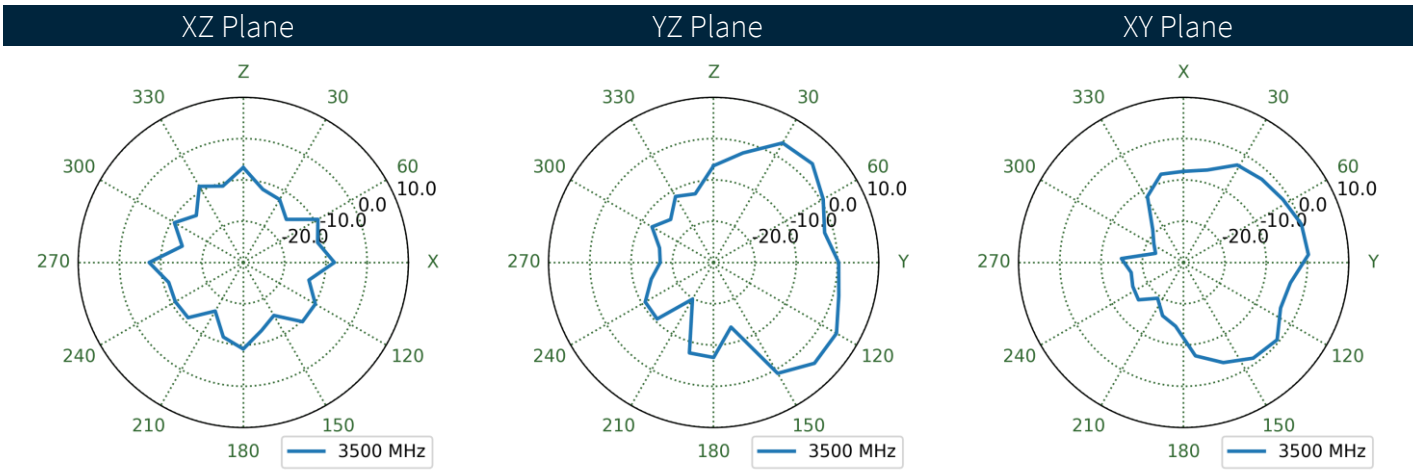
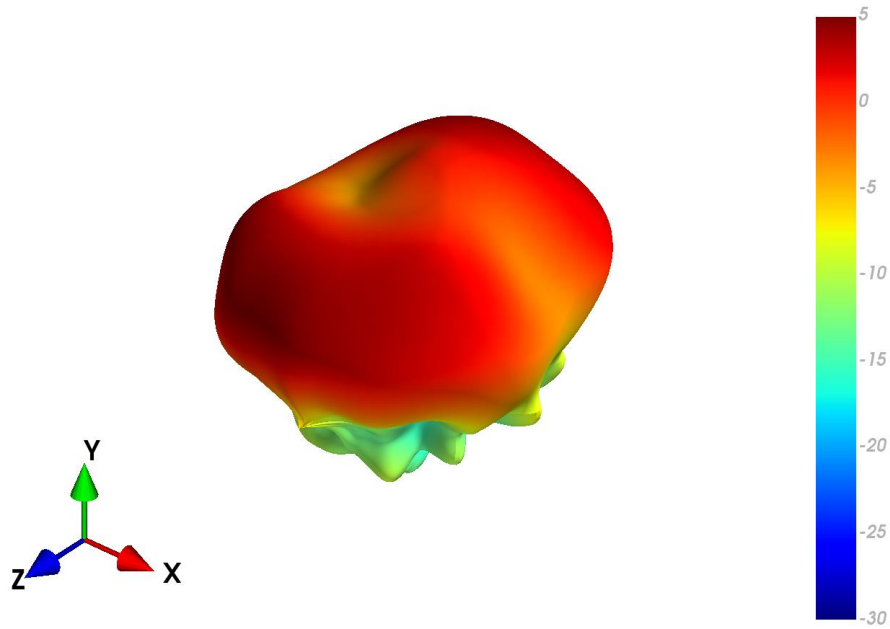

4.51 Bent in Free space - Patterns at 3500 MHz

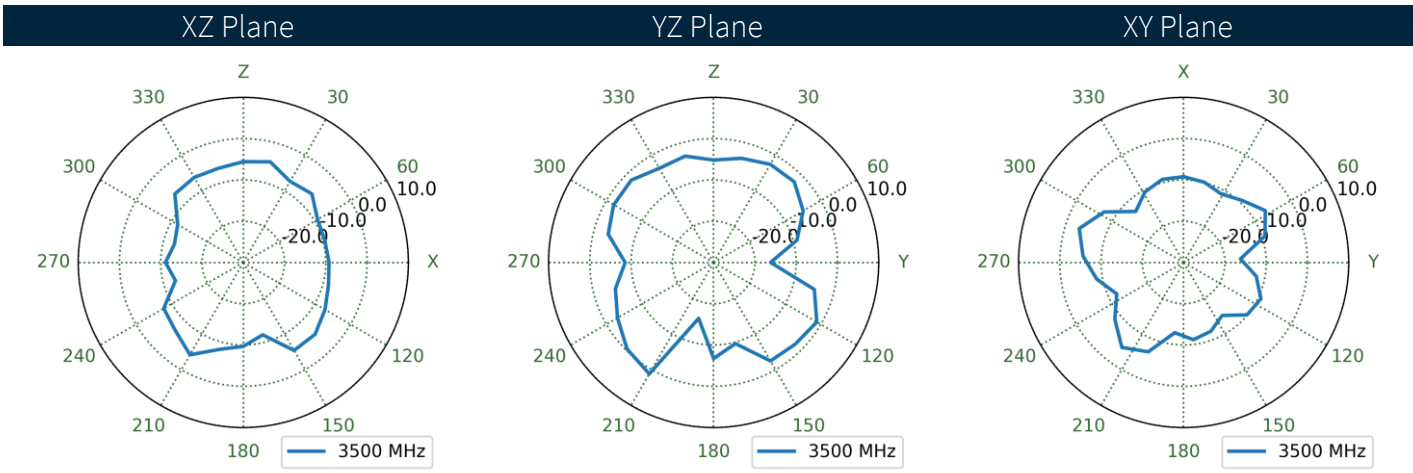
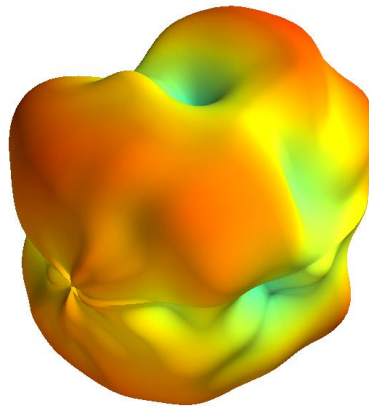
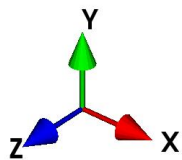

4.52 Bent (Edge) 30x30cm Ground plane - Patterns at 3500 MHz

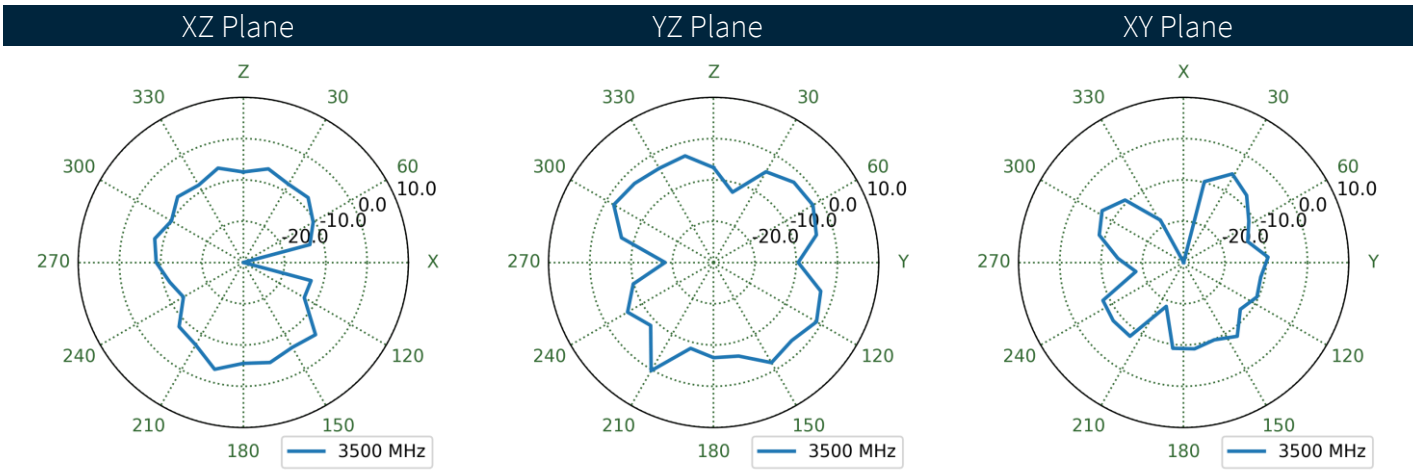
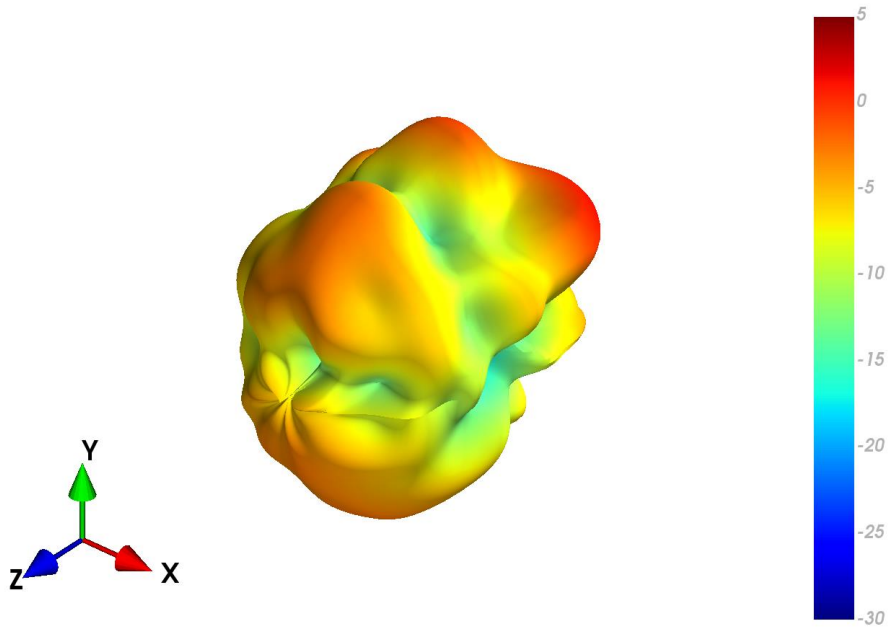

4.53 Straight (Centre) 30x30cm Ground plane - Patterns at 3500 MHz

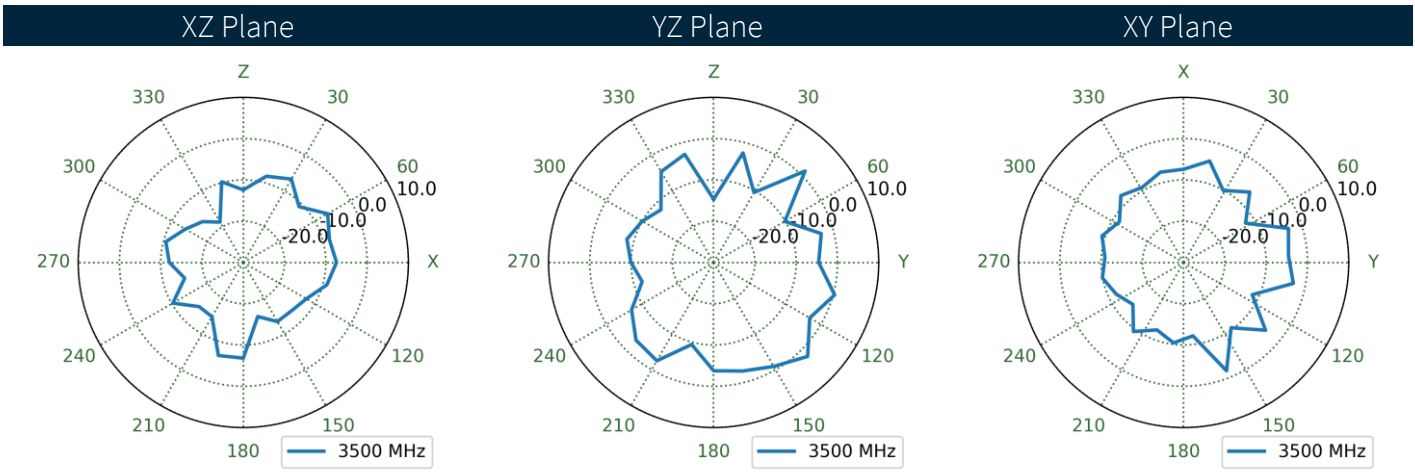
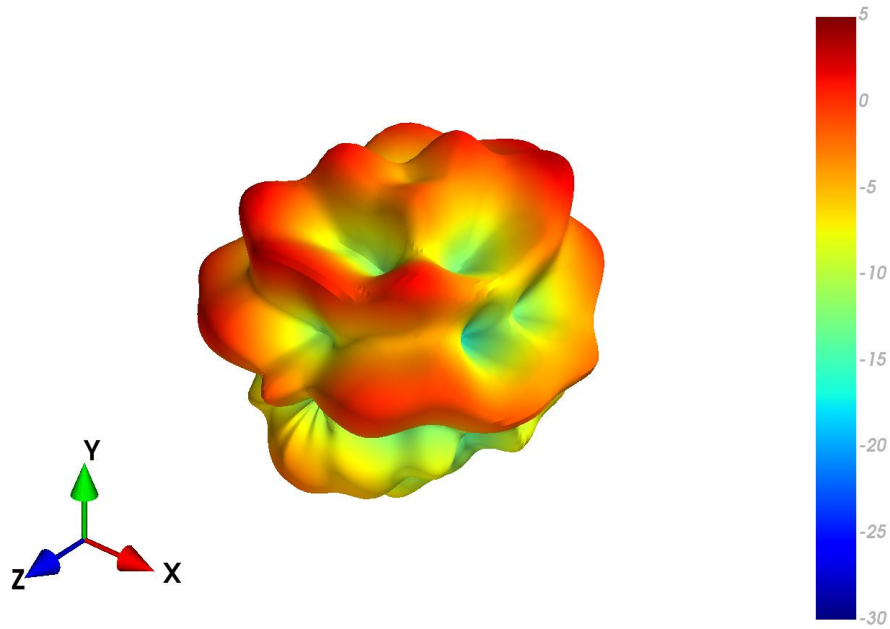

4.54 Straight in Free space - Patterns at 3500 MHz

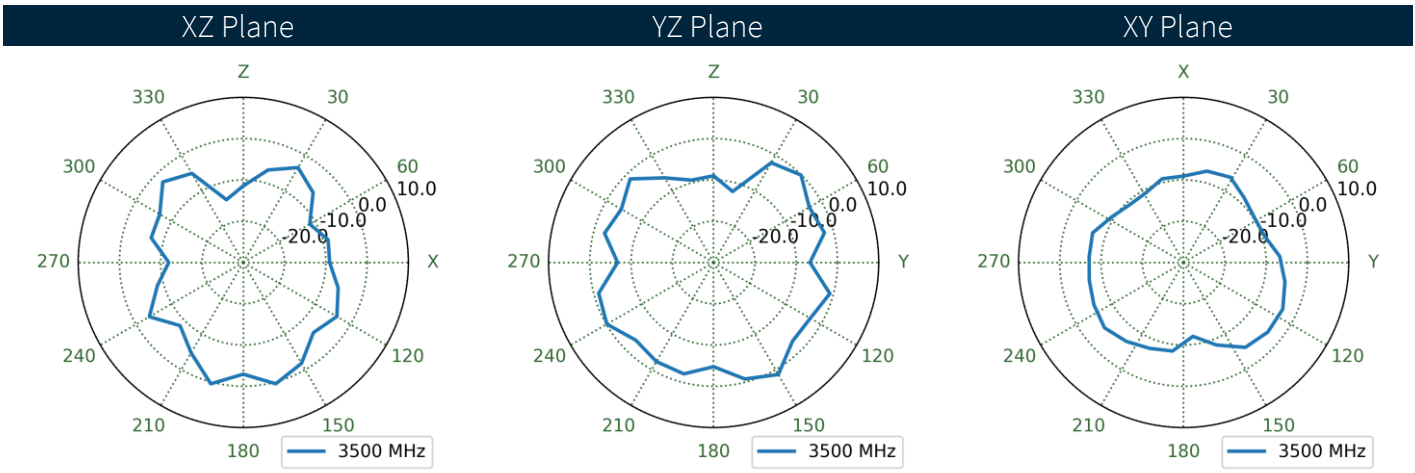
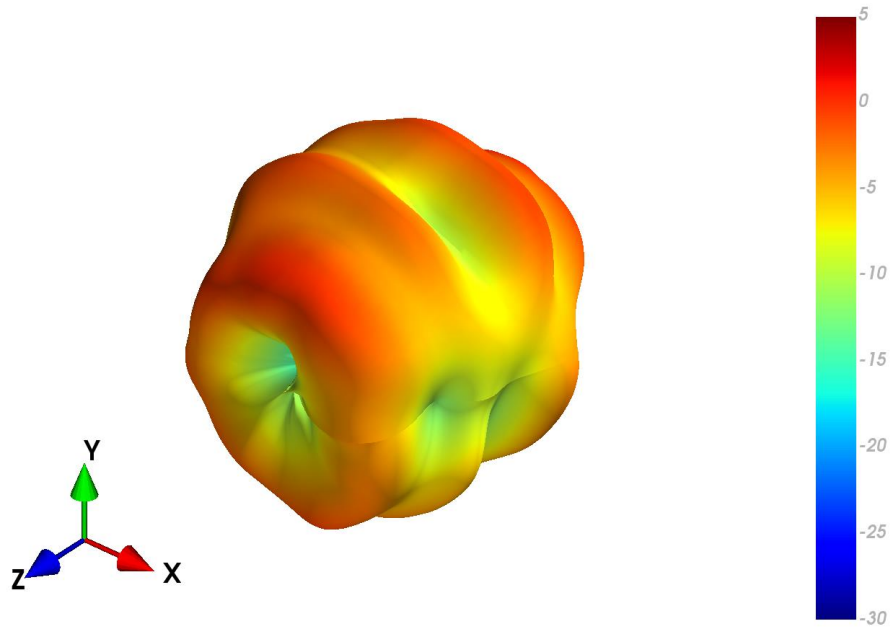

4.55 Straight (Edge) 30x30cm Ground plane - Patterns at 3500 MHz

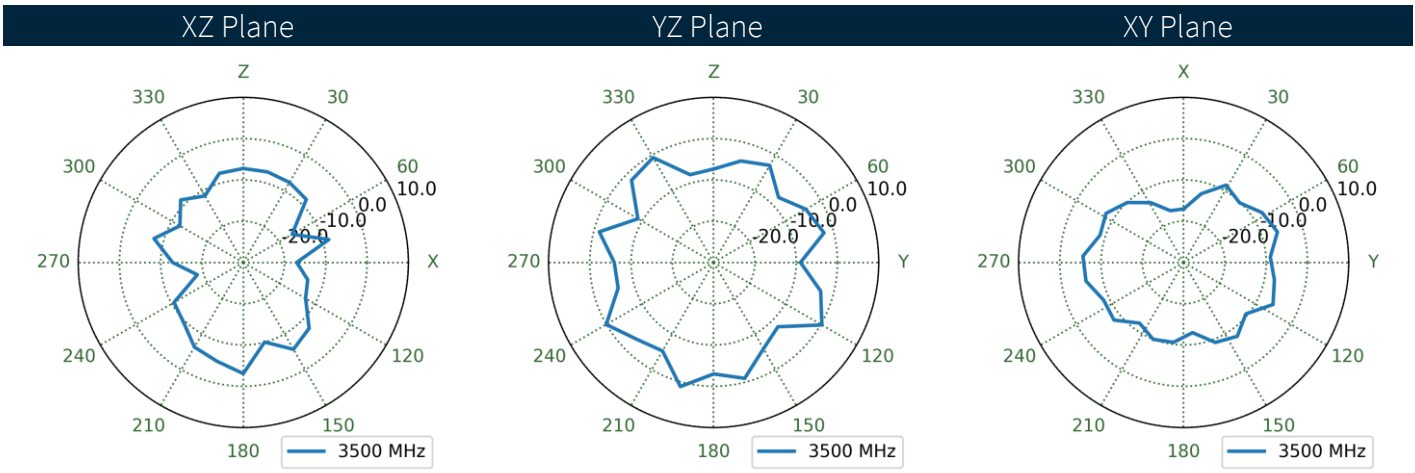
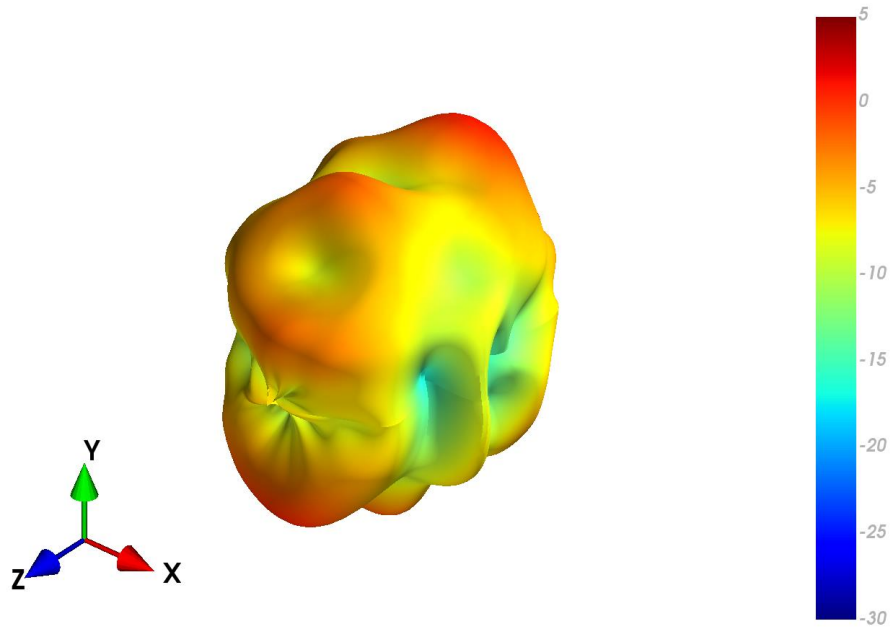

4.56 Bent (Centre) 30x30cm Ground plane - Patterns at 5150 MHz

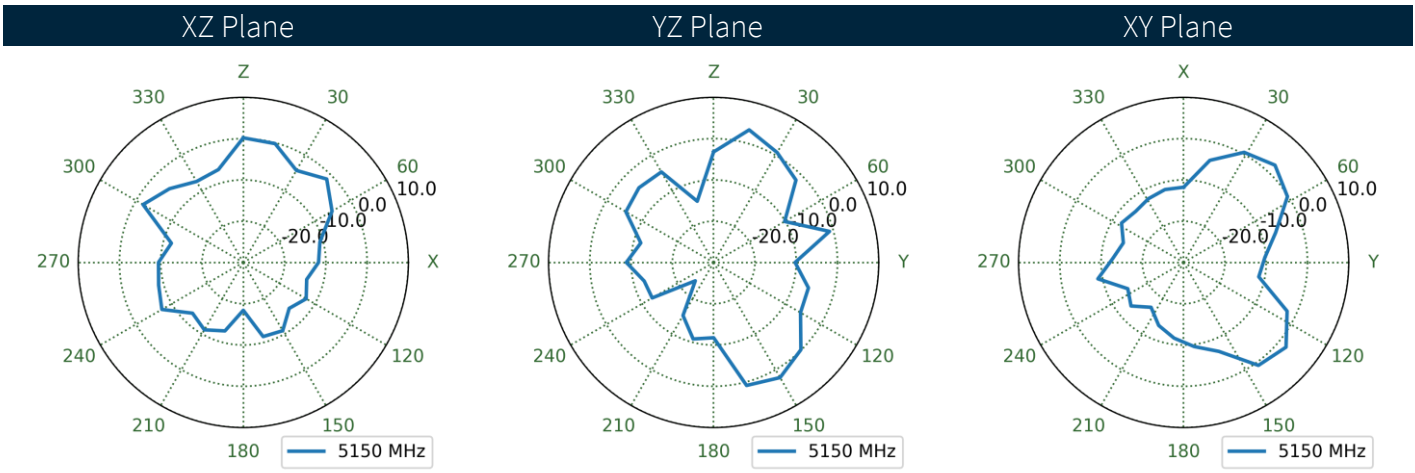
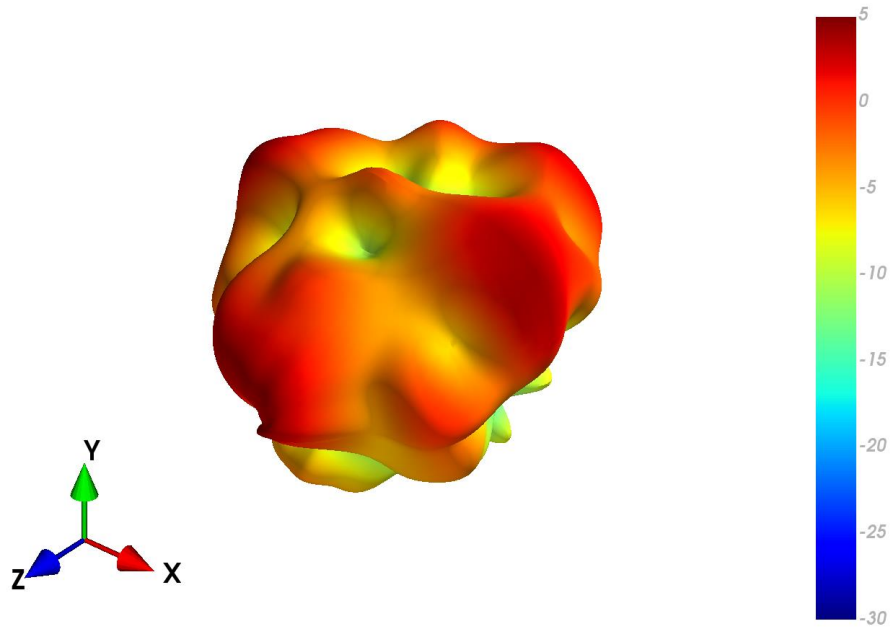

4.57 Bent in Free space - Patterns at 5150 MHz

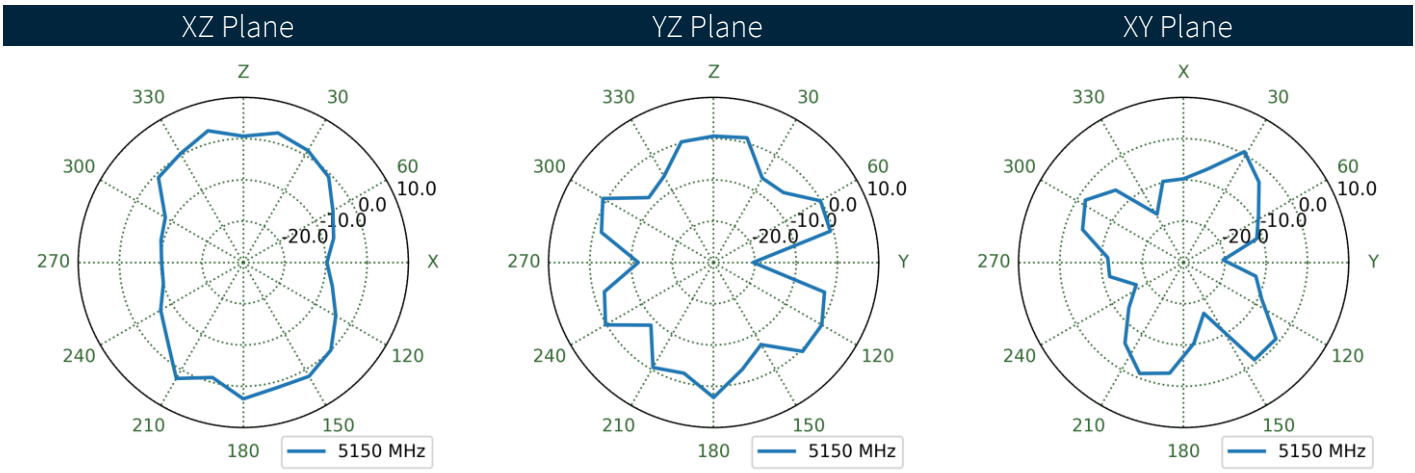
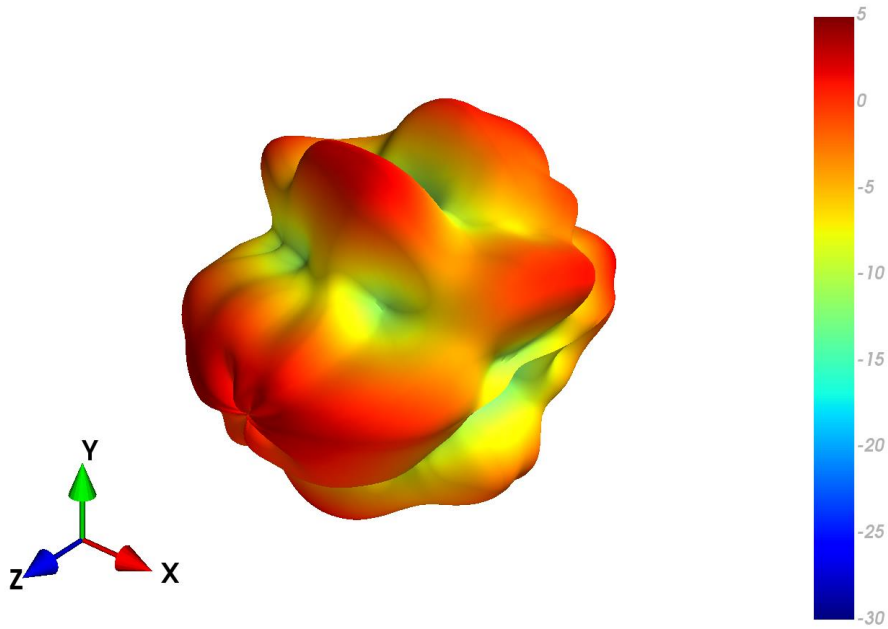

4.58 Bent (Edge) 30x30cm Ground plane - Patterns at 5150 MHz

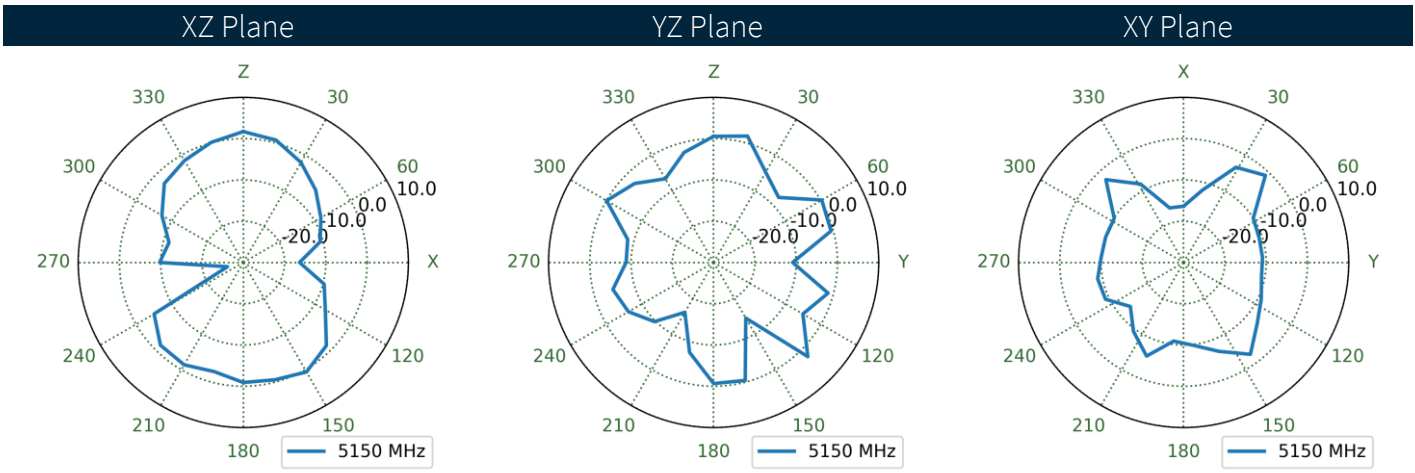
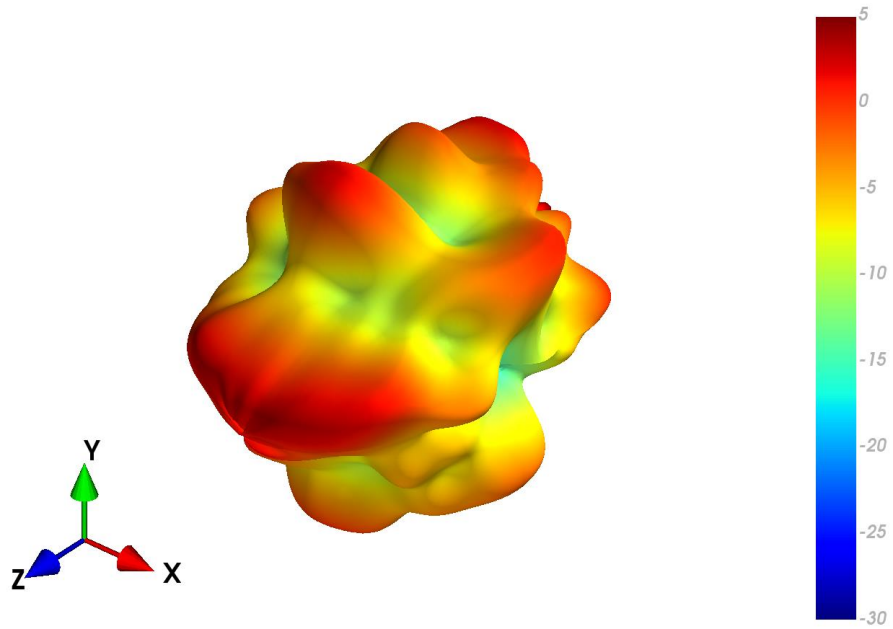

4.59 Straight (Centre) 30x30cm Ground plane - Patterns at 5150 MHz

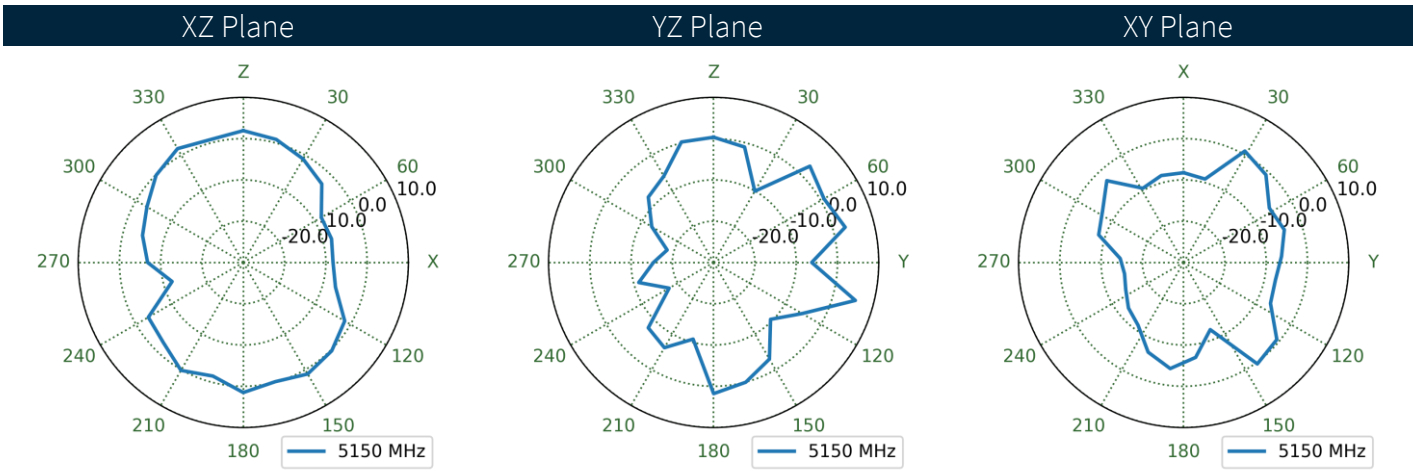
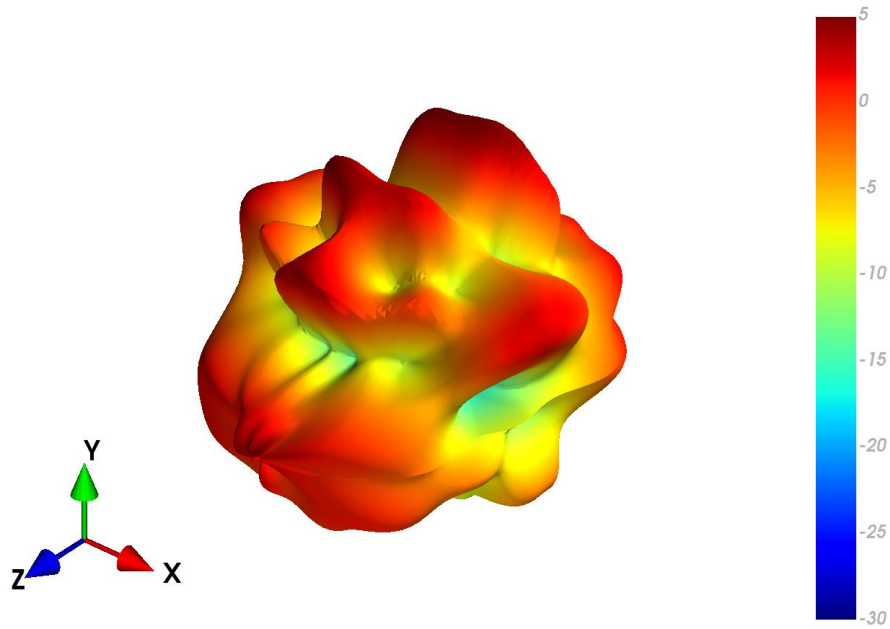

4.60 Straight in Free space - Patterns at 5150 MHz

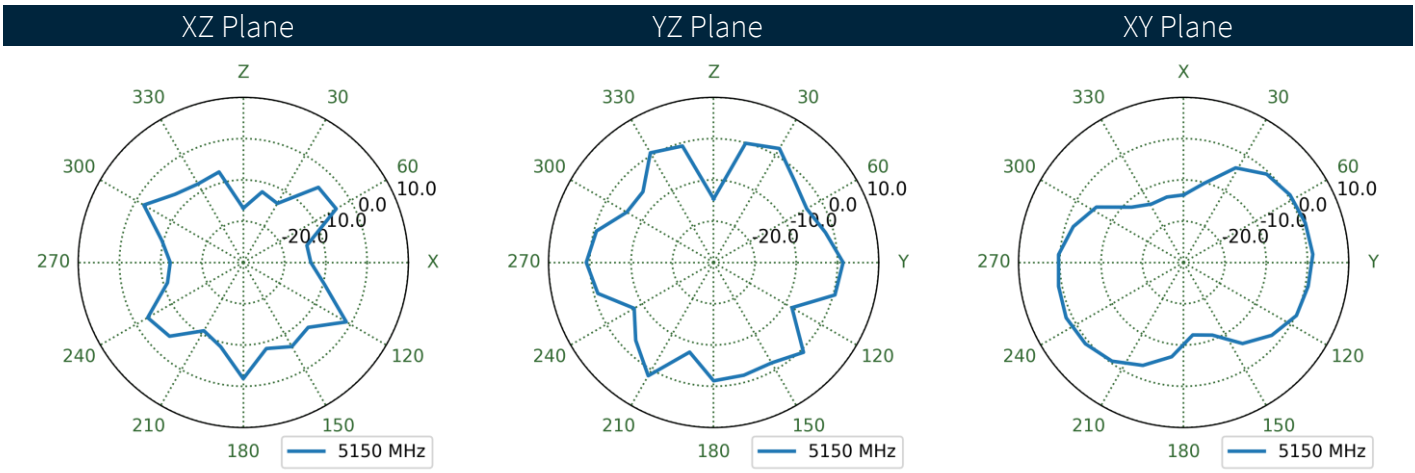
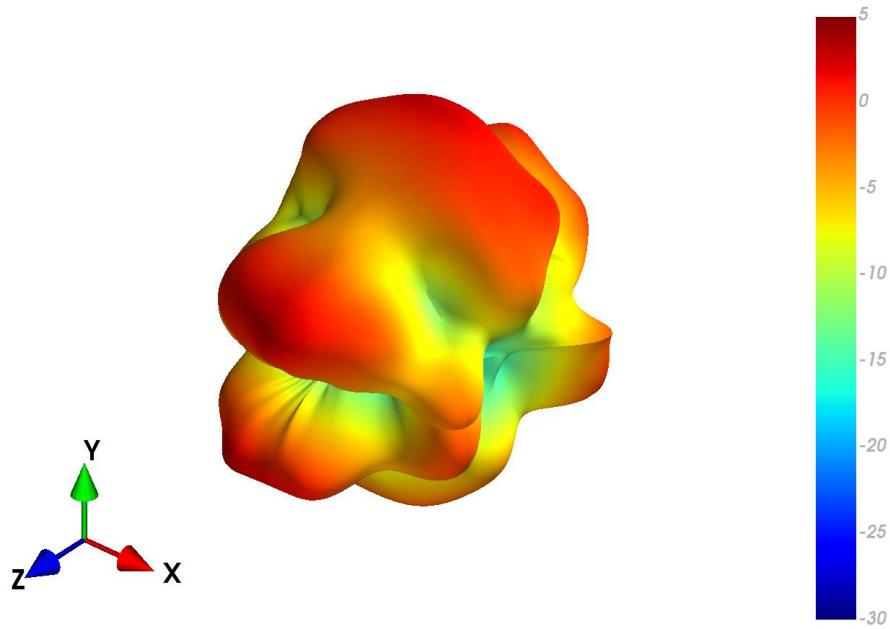

4.61 Straight (Edge) 30x30cm Ground plane - Patterns at 5150 MHz

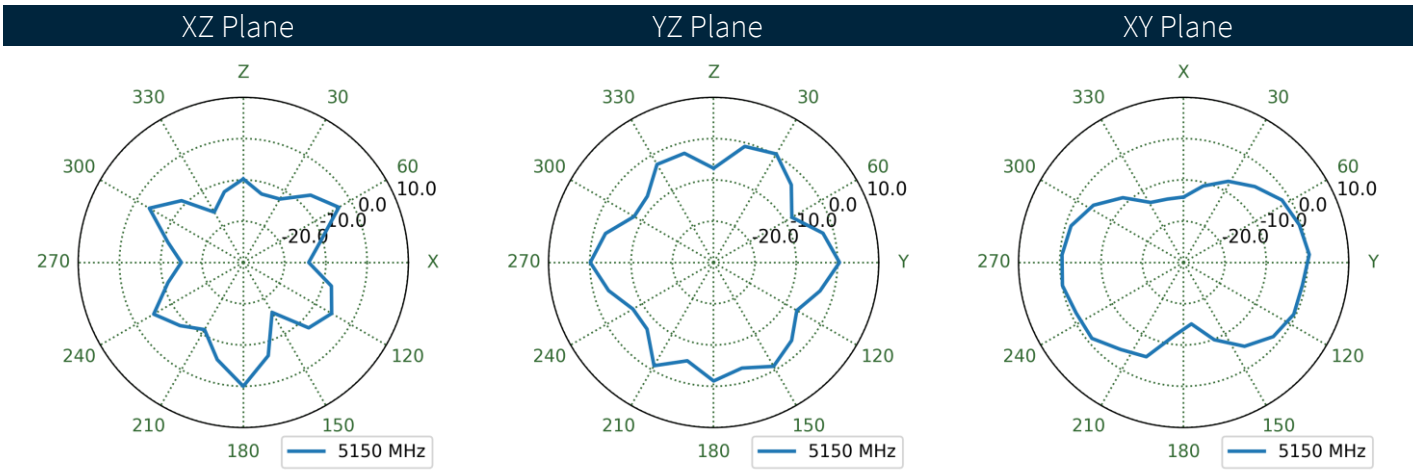
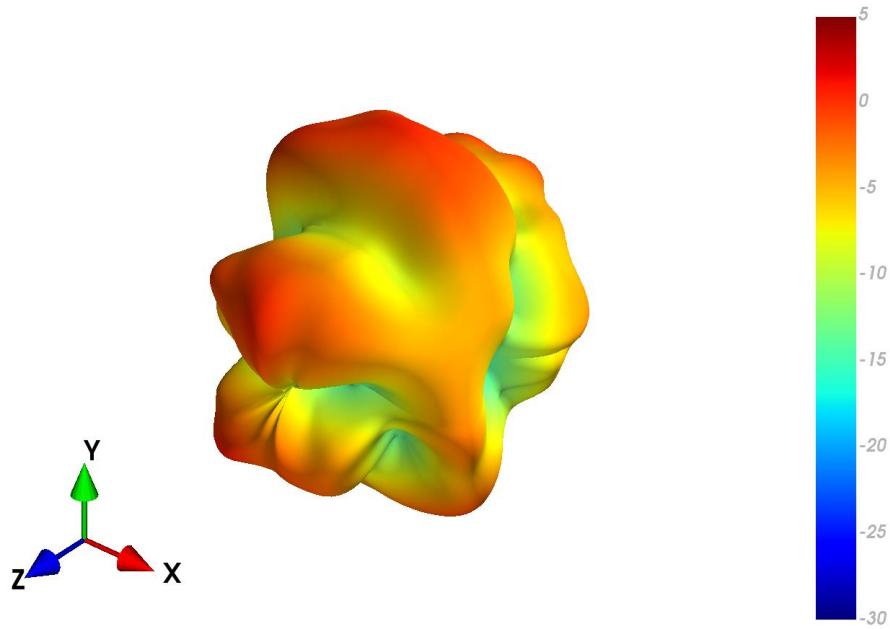

4.62 Bent (Centre) 30x30cm Ground plane - Patterns at 5550 MHz

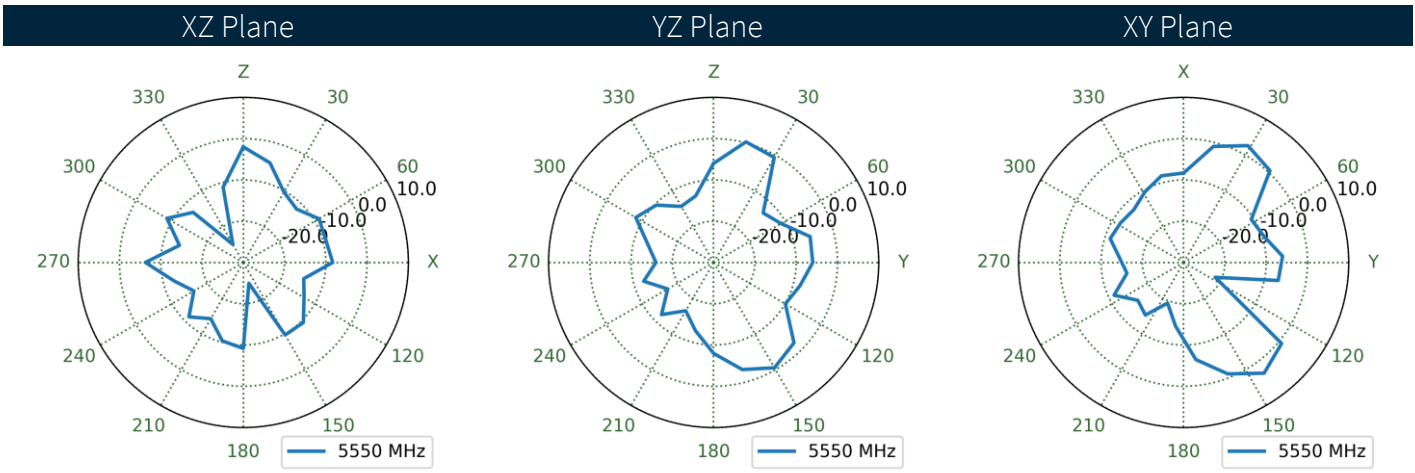
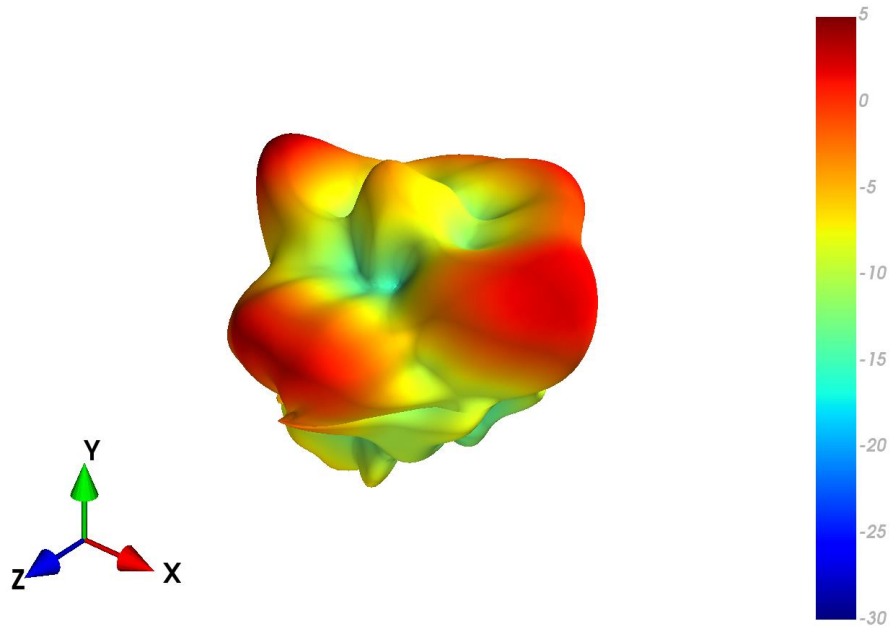

4.63 Bent in Free space - Patterns at 5550 MHz

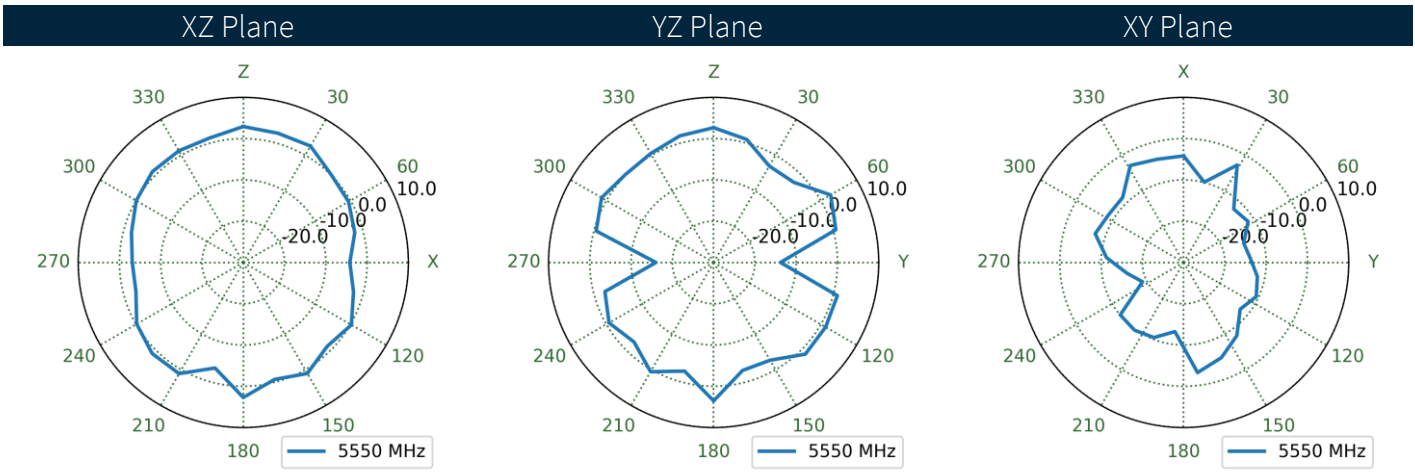
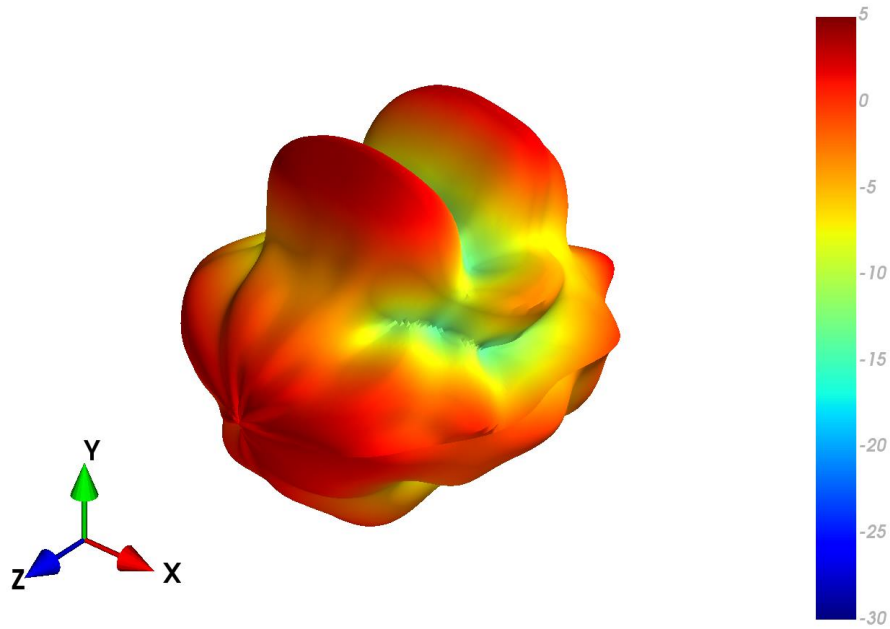

4.64 Bent (Edge) 30x30cm Ground plane - Patterns at 5550 MHz

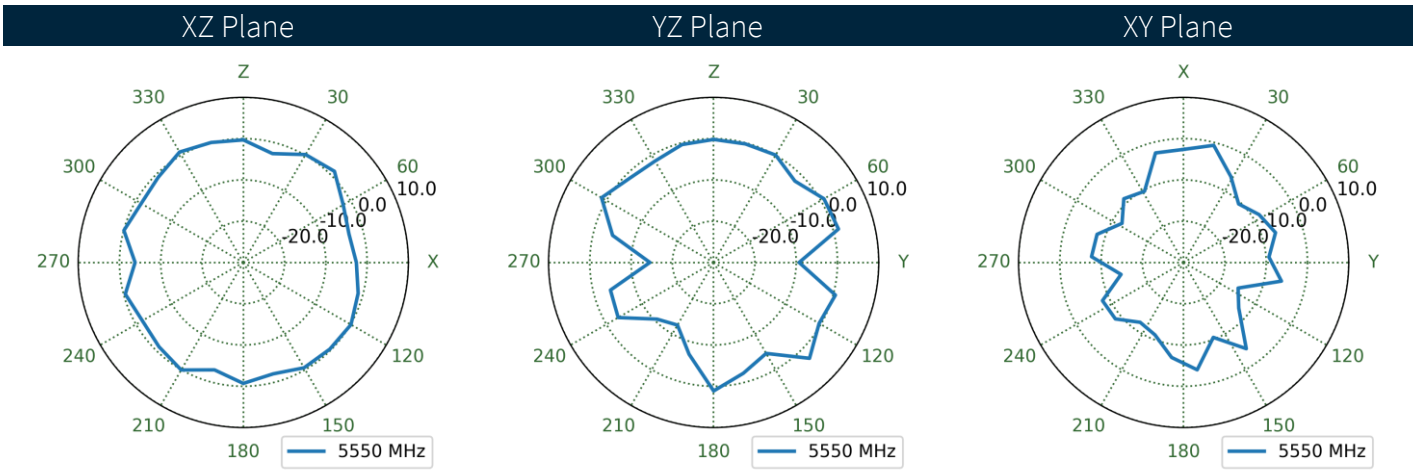
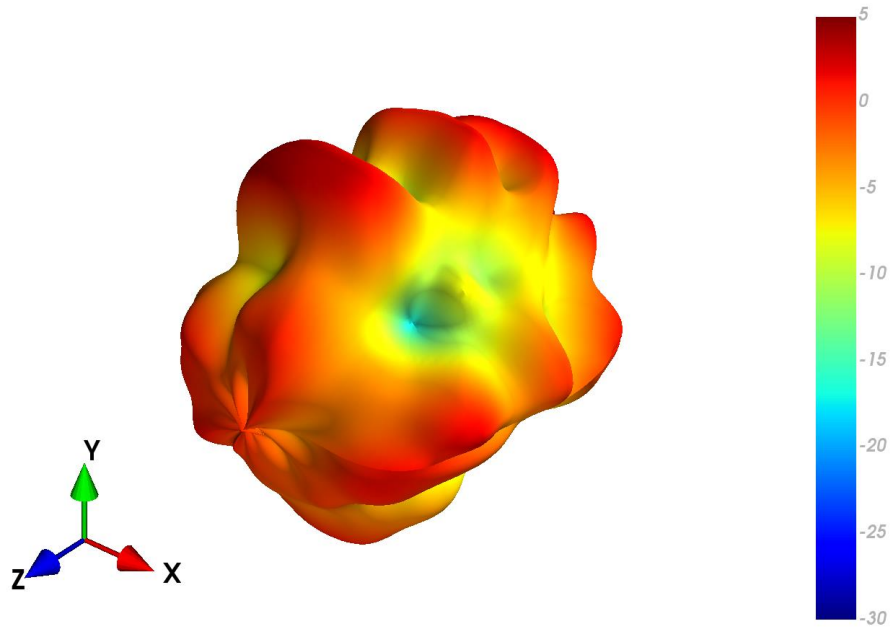

4.65 Straight (Centre) 30x30cm Ground plane - Patterns at 5550 MHz

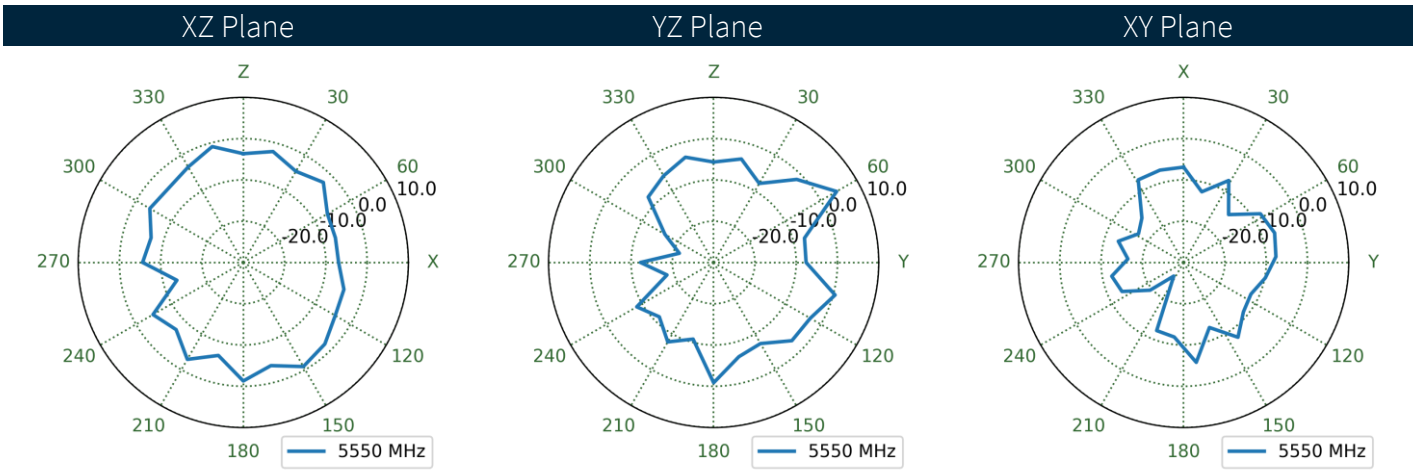
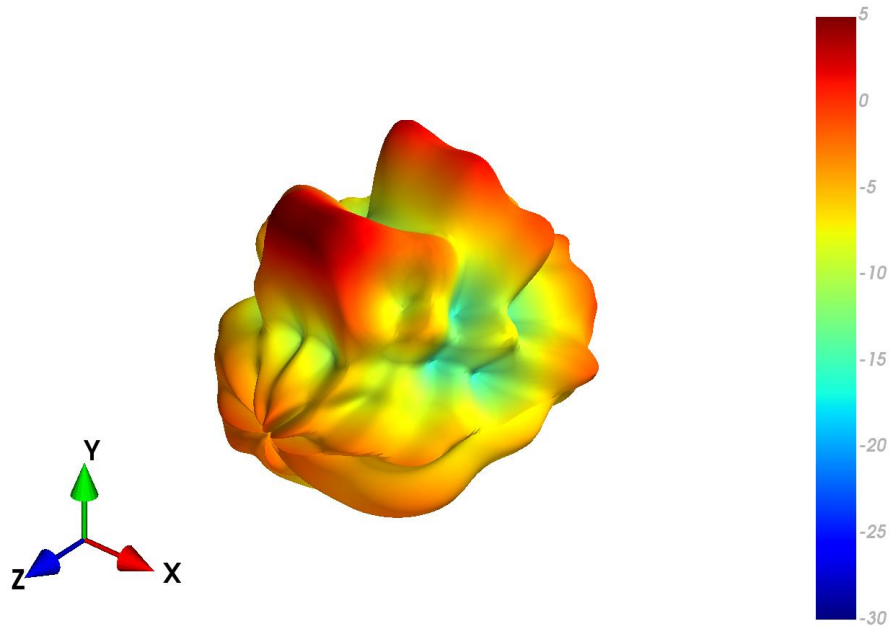

4.66 Straight in Free space - Patterns at 5550 MHz

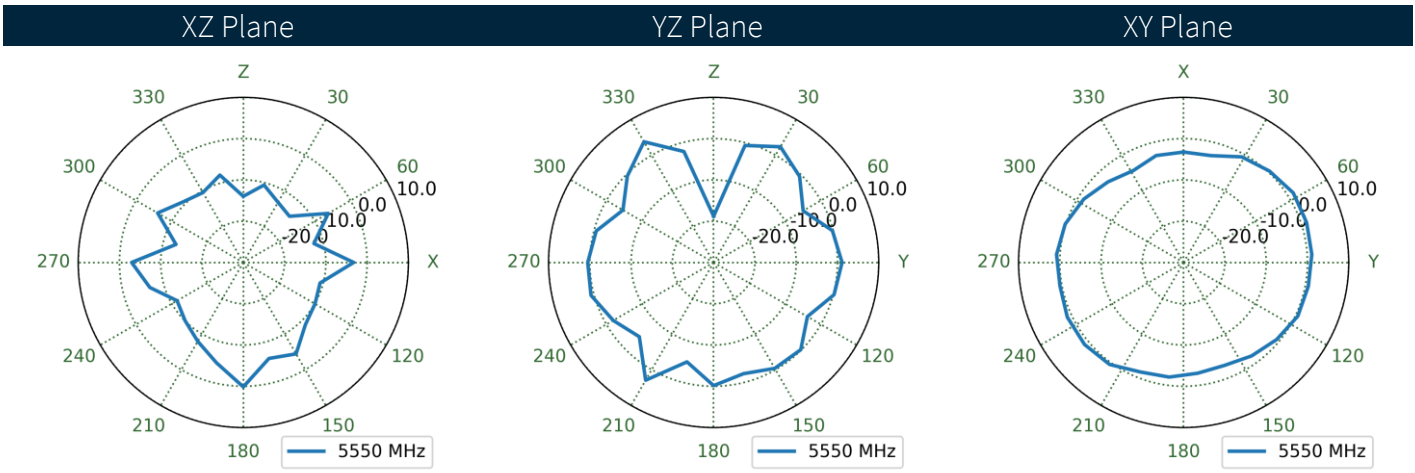
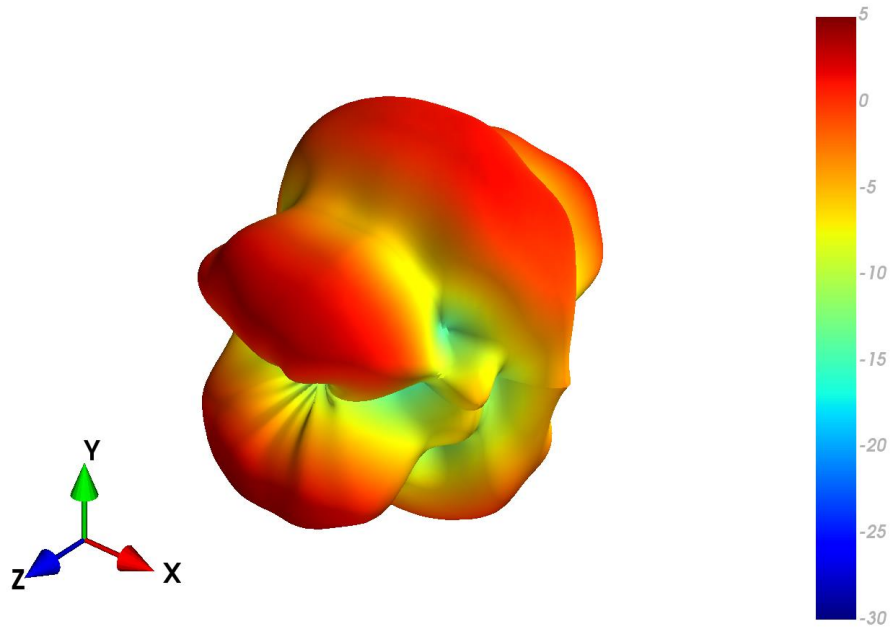

4.67 Straight (Edge) 30x30cm Ground plane - Patterns at 5550 MHz

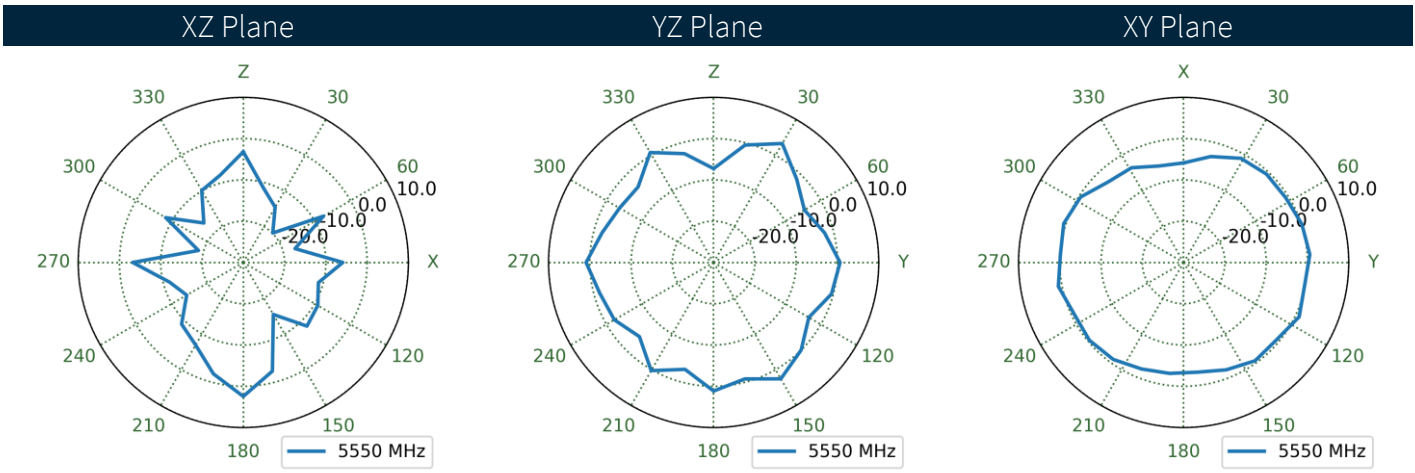
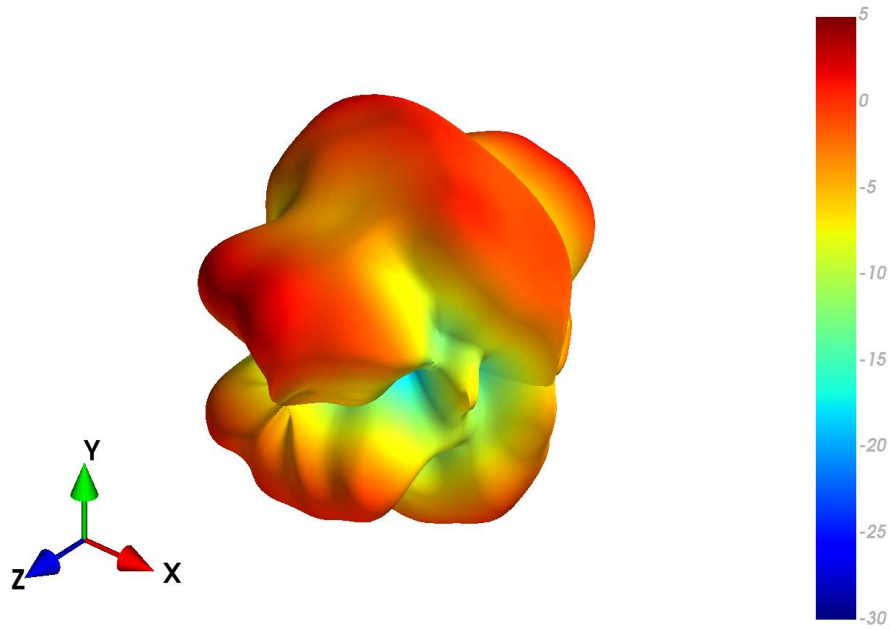

5. Mechanical Drawing

3D View

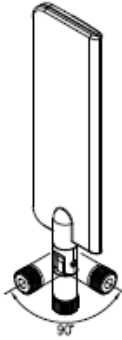

Front View

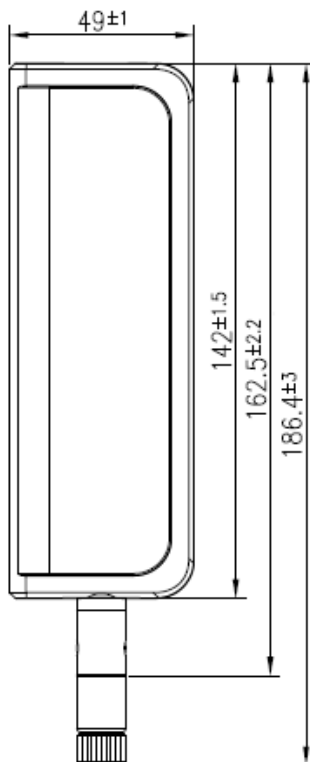

Side View

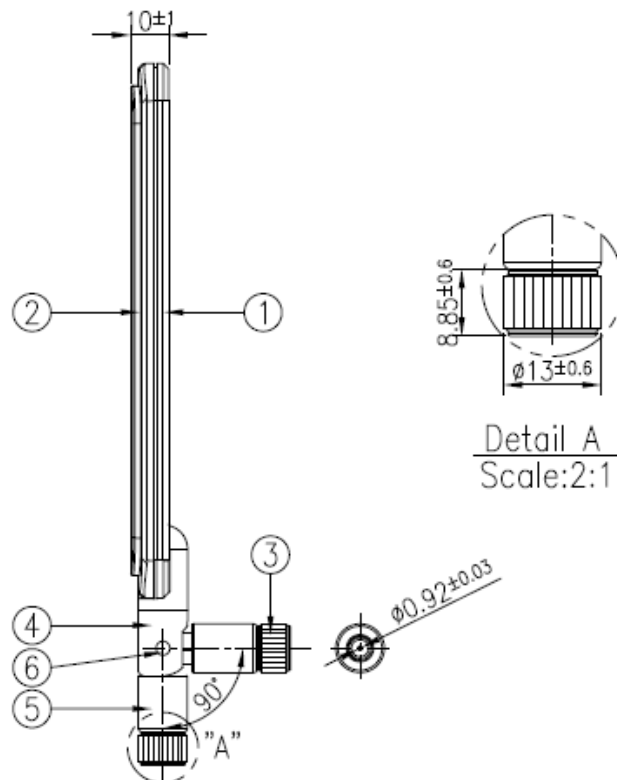

NOTES:

- 1.All material must be RoHS compliant.
- 2.Open/short, insertion loss QC required.
- 3.The connectors have a fixed orientation to each other.

	Name	P/N	Material	Finish	QTY
1	Housing_Bottom_Hinge_W	000112G020020A	ABS	White	1
2	Housing_Top_W	000112G000020A	ABS	White	1
3	SMA(M)ST	210212L020020A	Brass	White	1
4	Hinge_Top_W	000112G040020A	Nylon	White	1
5	Hinge_Bottom_W	000112G030020A	PC+PBT	White	1
6	Rotary Shaft	000612G000002A	Brass	Ni Plated	2

6. Packaging

1pc TG.30.8113W per Small PE Bag
 Small PE Bag Dimensions - 210*78mm
 Weight - 127g



50pcs TG.30.8113W per Large PE Bag
 Large PE Bag Dimensions - 450*275mm
 Weight - 6.35Kg

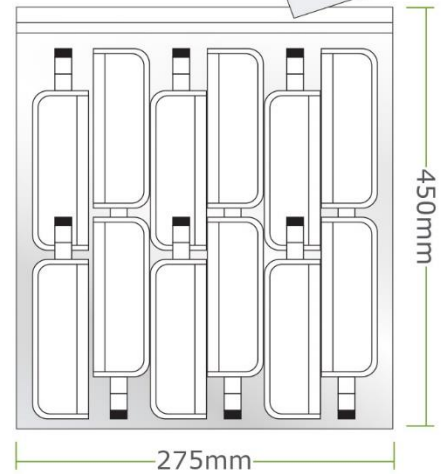

Changelog for the datasheet

SPE-12-8-125 - TG.30.8113W

Revision: M (Current Version)

Date:	2023-11-15
Changes:	Updated 5G/4G Bands table
Changes Made by:	Cesar Sousa

Previous Revisions

Revision: L

Date:	2023-01-16
Changes:	Adding band 40 to spec table (full datasheet update).
Changes Made by:	Gary West

Revision: G

Date:	2018-05-08
Changes:	Updated LTE band table - supports band 21
Changes Made by:	Technical Writer

Revision: K

Date:	2022-09-26
Changes:	Updated specifications
Changes Made by:	Cesar Sousa

Revision: F

Date:	2018-03-23
Changes:	Corrected flammability rating (UL-94 HB)
Changes Made by:	Technical Writer

Revision: J

Date:	2022-05-05
Changes:	Full datasheet template update and show data 600-6000.
Changes Made by:	Gary West

Revision: E

Date:	2018-03-13
Changes:	Adding flammability rating
Changes Made by:	Technical Writer

Revision: I

Date:	2018-08-14
Changes:	Change to IP Rating - Removed
Changes Made by:	David Connolly

Revision: D

Date:	2017-05-10
Changes:	D version appears in SVN on this date
Changes Made by:	Technical Writer

Revision: H

Date:	2018-06-14
Changes:	Re-tested "Bent on Ground Planer Edge" configuration and results are much improved and consistent with the other three test configuration results.
Changes Made by:	Technical Writer

Revision: C

Date:	2017-04-04
Changes:	Updated Spec with LTE table
Changes Made by:	Andy Mahoney

Previous Revisions

Revision: B	
Date:	2017-01-13
Changes:	
Changes Made by:	Technical Writer

Revision: A (Original First Release)	
Date:	2012-10-02
Notes:	
Author:	Technical Writer



www.taoglas.com

