

Click to  
**ORDER**  
samples

**AMES50-NZ**



Enclosed

The AMES50-NZ is an AC/DC converter that offers much greater cost effectiveness due to material normalization and production automation also leading to improved reliability and performance. Offering a commercial input voltage range of 85-264VAC and an output voltage range from 5-24V, this series will offer many benefits to your new system design.

This series offers great operating temperatures, from -30°C to 70°C and also features an isolation of 4000VAC for improved reliability and system safety. Furthermore, a high MTBF of 300,000h, output short circuit protection (OSCP), output over-current protection (OCP) and an output over-voltage protection (OVP) come standard with the series.

The AMES50-NZ is perfect for street lighting controls, grid power, instrumentation, industrial controls, communication, and civil applications.

**Features**

- Universal Input: 85 - 264VAC/120 - 373VDC
- Operating Temp: -30 °C to +70 °C
- High isolation voltage: Up to 4000VAC
- Low ripple & noise, 180mV(p-p) typ.
- Output short circuit, over-current, over-voltage protection
- Regulated Output
- Surge immunity: 300VAC for 5s

**Summary**

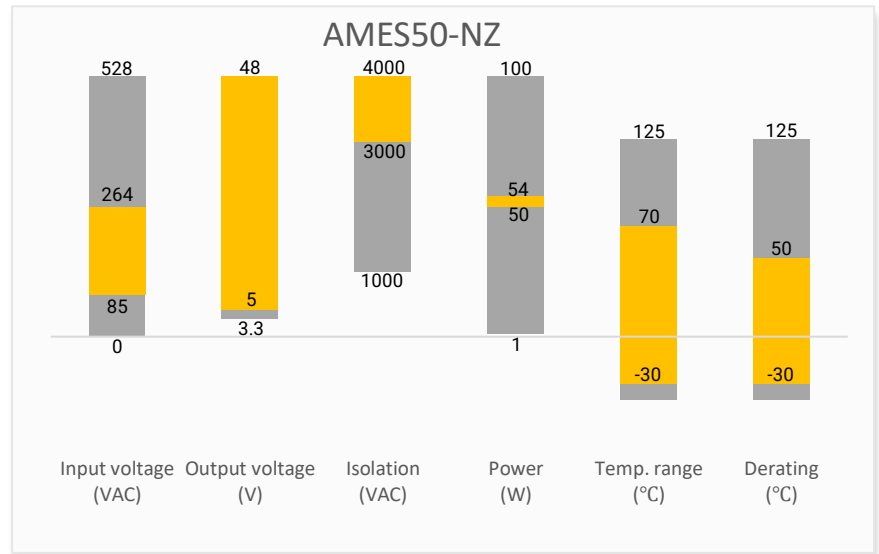

**Training**



Product Training Video  
(click to open)



Press Release

Coming Soon!

Application Notes

**Applications**



Power Grid



Industrial



Telecom



Instrumentation

## Models & Specifications

### Single Output

Model	Input Voltage (VAC/Hz)	Input Voltage (VDC)	Max Output Wattage (W)	Output Voltage (V)	Output Voltage Adjustable Range (V)	Output Current max (A)	Maximum capacitive load ( $\mu$ F)	Efficiency @230VAC Typ. (%)
AMES50-5SNZ	85-264/47-63	120-373	50	5	4.5-5.5	10	8500	83
AMES50-12SNZ	85-264/47-63	120-373	50.4	12	10.2-13.8	4.2	2000	86
AMES50-15SNZ	85-264/47-63	120-373	51	15	13.5-18	3.4	1500	88
AMES50-24SNZ	85-264/47-63	120-373	52.8	24	21.6-28.8	2.2	1000	88
AMES50-36SNZ	85-264/47-63	120-373	52.2	36	32.4-39.6	1.45	800	89
AMES50-48SNZ	85-264/47-63	120-373	52.8	48	43.2-52.8	1.1	680	90

Note: Add suffix "-P" for optional terminal protective cover (ex. AMES50-5SNZ-P is terminal with protective cover version) or suffix "-Q" for conformal coating (ex. AMES50-5SNZ-Q is conformal coating version).

### Dual Output

Model	Input Voltage (VAC/Hz)	Input Voltage (VDC)	Max Output Wattage (W)	Output Voltage (Vo1/Vo2) (V)	Working Current Range (Io1/Io2) (A)*	Output Current (Io1/Io2) (A)	Maximum capacitive load (Vo1/Vo2) ( $\mu$ F)	Efficiency @230VAC (%)
AMES50-0512DNZ	85-264/47-63	120-373	54	5/12	0.3-6/0.2-3	6/2	6000/2000	83
AMES50-0524DNZ	85-264/47-63	120-373	53.6	5/24	0.4-6/0.14-2	4/1.4	4000/1000	84

Note: Use suffix "-Q" for conformal coating (ex. AMES50-0512DNZ -Q is conformal coating version).

\*Maximum duration 3sec when any of the outputs reaches its maximum working current. Total output power cannot exceed the rated power.

### Tri Output

Model	Input Voltage (VAC/Hz)	Input Voltage (VDC)	Max Output Wattage (W)	Output Voltage (Vo1/Vo2/Vo3) (V)	Working Current Range (Io1/Io2/Io3) (A)*	Output Current (Io1/Io2/Io3) (A)	Maximum capacitive load (Vo1/Vo2/Vo3) ( $\mu$ F)	Efficiency @230VAC (%)
AMES50-051212TNZ	85-264/47-63	120-373	50	+5/+12/-12	0.4-5/0.2-2.5/0.1-1	4/2/0.5	4000/2000/470	81
AMES50-051515TNZ	85-264/47-63	120-373	50	+5/+15/-15	0.4-5/0.15-2/0.1-1	4/1.5/0.5	4000/1500/470	83
AMES50-052412TNZ	85-264/47-63	120-373	51	+5/+24/+12	0.3-5/0.1-1.5/0.1-1.5	3/1/1	3000/1000/1000	85

Note: Use suffix "-Q" for conformal coating (ex. AMES50-051212TNZ -Q is conformal coating version).

\*Maximum duration 3sec when any of the outputs reaches its maximum working current. Total output power cannot exceed the rated power.

### Input Specifications

Parameters	Conditions	Typical	Maximum	Units
Input current	Single output, 115VAC		1.2	A
	Single output, 230VAC		0.8	A
	Others, 115VAC		1.3	A
	Others, 230VAC		0.8	A
Inrush current	Single output, cold start, 115VAC	30		A
	Single output, cold start, 230VAC	50		A
	Others, cold start, 115VAC	30		A
	Others, cold start, 230VAC	50		A

Leakage current	Single output, 240VAC		0.75	mA
	others, 240VAC		2.0	mA

Output Specifications				
Parameters	Conditions	Typical	Maximum	Units
Voltage accuracy	Single output, Full load, 5V output	±2		%
	Single output, Full load, Others	±1		%
	Dual output, Full load, Output 1	±2		%
	Dual output, Full load, AMES50-0512DNZ, Output 2	±8		%
	Dual output, Full load, AMES50-0524DNZ, Output 2	≥ -4	+8	%
	Tri output, Full load, Output 1	±2		%
	Tri output, Full load, AMES50-051212TNZ, Output 2	±6		%
	Tri output, Full load, Others, Output 2	≥ -4	+8	%
	Tri output, Full load, AMES50-052412TNZ, Output 3	±6		%
Tri output, Full load, Others, Output 3	±3	±5	%	
Line regulation	Single output, Full load	±0.5		%
	Dual output, Full load, Output 1	±0.5		%
	Dual output, Full load, Output 2	±1.5		%
	Tri output, Full load, Output 1	±0.5		%
	Tri output, Full load, AMES50-052412TNZ, Output 2	±2		%
	Tri output, Full load, Others, Output 2	±1.5		%
	Tri output, Full load, AMES50-052412TNZ, Output 3	±2		%
Tri output, Full load, Others, Output 3	±0.5		%	
Load regulation**	Single output, 0-100% load, 5V output	±1		%
	Single output, 0-100% load, Others	±0.5		%
	Dual output, 10-100% load, Output 1	±0.5		%
	Dual output, 10-100% load, Output 2	±5		%
	Tri output, 10-100% load, Output 1	±1		%
	Tri output, 10-100% load, Output 2	±3	±5	%
	Tri output, 10-100%, AMES50-052412TNZ, Output 3	±4		%
	Tri output, 10-100% load, Others, Output 3	±1		%
Ripple & Noise*	Single output, 5V output	80		mV p-p
	Single output, 12V,15V output	120		mV p-p
	Single output, 24V output	150		mV p-p
	Single output, 36V,48V output	200		mV p-p
	Dual output, Output 1	80		mV p-p
	Dual output, AMES50-0512DNZ, Output 2	120		mV p-p
	Dual output, AMES50-0524DNZ, Output 2	150		mV p-p
	Tri output, Output 1	80		mV p-p
	Tri output, AMES50-052412TNZ, Output 2	150		mV p-p
	Tri output, others, Output 2	120		mV p-p
Tri output, Output 3	120		mV p-p	
Hold up time	Single output, 115VAC	≥ 8		ms
	Single output, 230VAC	≥ 30		ms
	Others, 115VAC	5		ms
	Others, 230VAC	30		ms
Voltage adjustable range	Output 1 of dual, tri output models	4.75 – 5.5		V
Start-up delay time	Dual, tri output		3	S
Rise time	Dual, Tri output, 115/230VAC		30	mS

\* Ripple and Noise are measured at 20MHz bandwidth with a 47μF electrolytic capacitor and a 0.1μF ceramic capacitor. Please refer to the application note for specific details.  
\*\* Equal-scale load for dual and tri output models.

Isolation Specifications				
Parameters	Conditions	Typical	Rated	Units
Tested I/O voltage	60 sec, leakage current < 10mA, Single output		4000	VAC
	60 sec, leakage current < 10mA, Dual, tri output		3000	VAC
Tested Input to GND voltage	60 sec, leakage current < 10mA, Single, Dual, tri output		2000	VAC
Tested Output to GND voltage	60 sec, leakage current < 10mA, Single output		1250	VAC
	60 sec, leakage current < 10mA, Dual, tri output		500	VAC
Tested Vo1 to Vo2 voltage	Dual output models only		500	VDC
Resistance (I/O, I/O to GND)	500VDC, Single output		50	MΩ
	500VDC, Dual, tri output		100	MΩ

General Specifications				
Parameters	Conditions	Typical	Maximum	Units
Safety class	Class I			
Switching Frequency	Single output	65		KHz
Over current protection	Single output, Auto recovery	≥ 110	200	% of Iout
	Dual output, equal-scale load, Auto recovery	≥ 110	230	% of Iout
	Tri output, equal-scale load, Auto recovery	≥ 110	230	% of Iout
Over voltage protection	Single output, 5V output, Voltage clamp or hiccup		6.3	VDC
	Single output, 12V output, Voltage clamp or hiccup		16.2	VDC
	Single output, 15V output, Voltage clamp or hiccup		21.75	VDC
	Single output, 24V output, Voltage clamp or hiccup		33.6	VDC
	Single output, 36V output, Voltage clamp or hiccup		48.6	VDC
	Single output, 48V output, Voltage clamp or hiccup		60	VDC
	Dual, tri output, Voltage clamp	5.75 ≤ Output 1 ≤ 6.75		VDC
Short circuit protection*	Hiccup, Continuous, Auto recovery, Recovery time < 5 sec			
Operating temperature	See derating graph	-30 to +70		°C
Storage temperature		-40 to +85		°C
Power consumption	Single output		0.3	W
Power derating	Single output, -30°C to -25°C, 85VAC - 100VAC	5		% / °C
	Single output, 40°C to 70°C, 85VAC - 165VAC, 5V output	1.33		% / °C
	Single output, 50°C to 70°C, 165VAC - 264VAC, 5V output	2		% / °C
	Single output, 50°C to 70°C, 12/15/24V output	2		% / °C
	Single output, 85VAC - 100VAC	1.33		% / VAC
	Dual output, 45°C to 70°C	2		% / °C
	Tri output, 50°C to 70°C	2.5		% / °C
	Dual, tri output, 85VAC - 115VAC	0.66		% / VAC
Ambient temperature derating	Operating altitude > 2000m	5		°C / 1000m
Temperature coefficient		±0.03		% / °C
Cooling	Free air convection			
Humidity	Non-condensing, Storage		95	% RH
	Non-condensing, Operating	≥ 20	90	% RH
Case material	Metal (1100 Aluminum, SGCC)			
Weight	Single output	180		g
	Dual output	235		g
	Tri output	240		g
Dimensions (L x W x H)	Single output	3.90 x 3.23 x 1.18inch (99.0 x 82.0 x 30.0mm)		
	Dual, tri output	3.90 x 3.82 x 1.18inch (99.0 x 97.0 x 30.0mm)		
MTBF	> 300 000 hrs (MIL-HDBK -217F, t=+25°C)			
NOTE: All specifications in this datasheet are measured at an ambient temperature of 25°C, humidity<75%, nominal input voltage and at rated output load unless otherwise specified.				
*Output 3 cannot be shorted for long period of time.				

## Safety Specifications

### Parameters

Agency approvals UL 62368-1 (Single output models only)

Design to meet EN61558, over-voltage class III (Single output models only)

Information technology Equipment

Design to meet IEC/EN/UL 62368, EN60335, GB4943

EMC - Conducted and radiated emission

CISPR32 / EN55032, class B

Harmonic current

IEC 61000-3-2 Class A

Electrostatic Discharge Immunity

IEC 61000-4-2 Contact  $\pm 6$ KV / Air  $\pm 8$ KV, Criteria A

RF, Electromagnetic Field Immunity

IEC 61000-4-3 10V/m, Criteria A

Electrical Fast Transient/Burst Immunity

IEC 61000-4-4  $\pm 2$ KV, Criteria A (Single and dual output models)  
IEC 61000-4-4  $\pm 4$ KV, Criteria A (Tri output models)

Surge Immunity

IEC 61000-4-5 L-L  $\pm 2$ KV/L-G  $\pm 4$ KV, Criteria A

RF, Conducted Disturbance Immunity

IEC 61000-4-6 10Vr.m.s, Criteria A

Voltage dips, Short Interruptions Immunity

IEC 61000-4-11 0%, 70%, Criteria B

## Single Output Models Derating

Free Air Convection

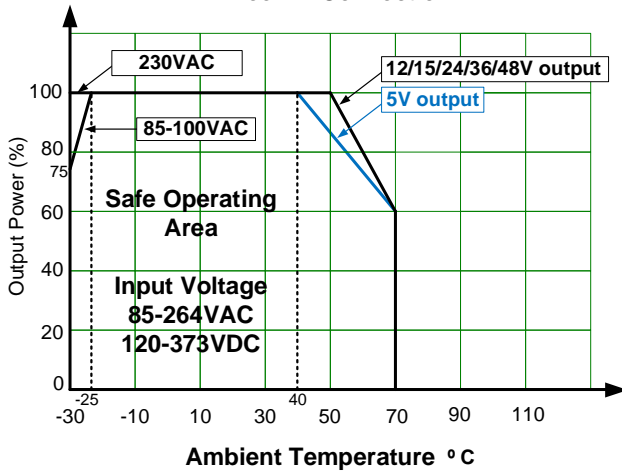

Free Air Convection at 25°C

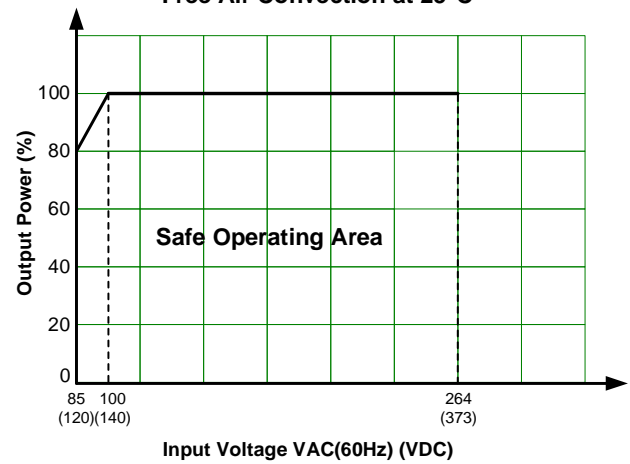

## Dual, Tri Output Models Derating

Free Air Convection

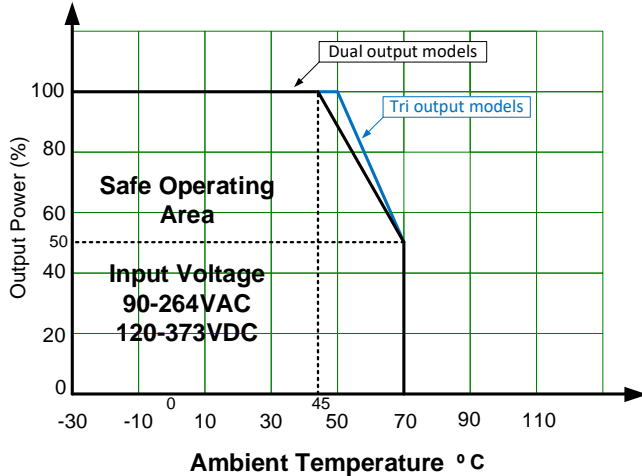

Free Air Convection at 25°C

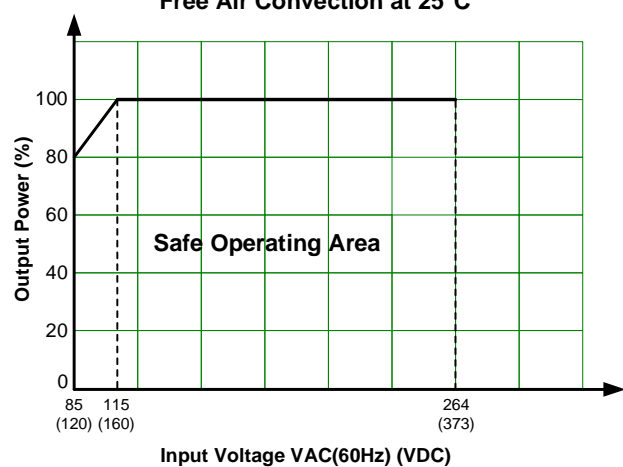

## Single Output Models Dimensions

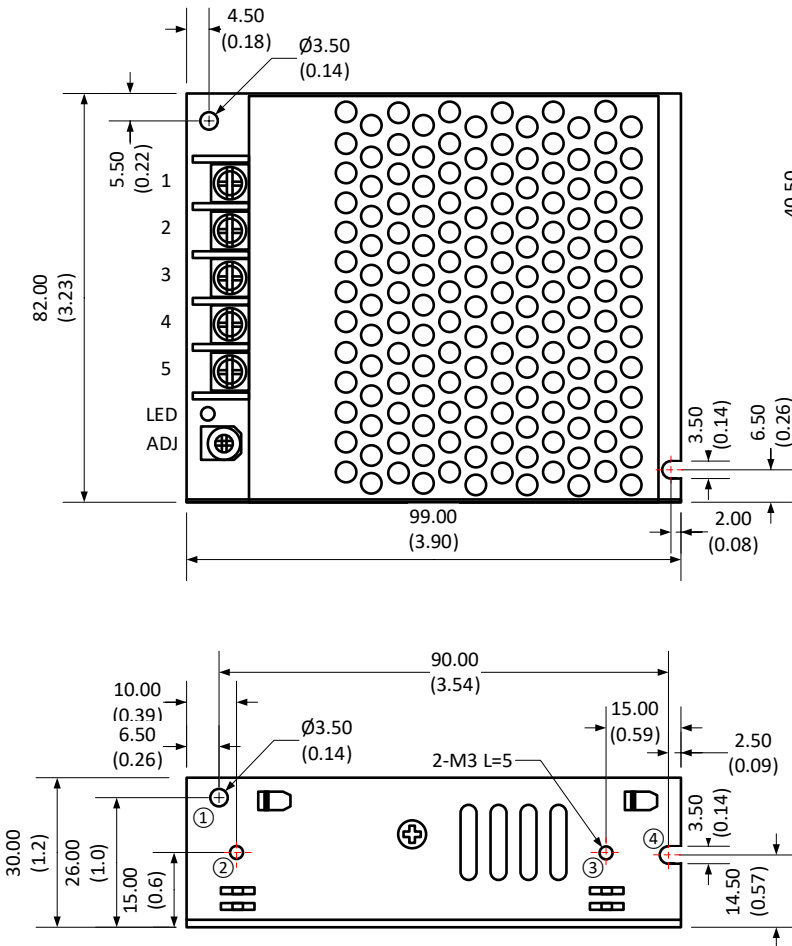

**Note:**

Unit: mm(inch)

Wire gauge: 22-12AWG

Screw terminal tightening torque: M4, 1.2N-m

Mounting screw tightening torque: M3, 0.4N-m

General tolerance:  $\pm 1.0(0.04)$

At least one of the ① - ⑧ location must be connected to PE

### Single Pin Output Specifications

Pin	Function
1	Input (L)
2	Input (N)
3	PE GND
4	-V Output
5	+V Output
ADJ	Vo1 voltage adj knob

## Dual, Tri Output Models Dimensions

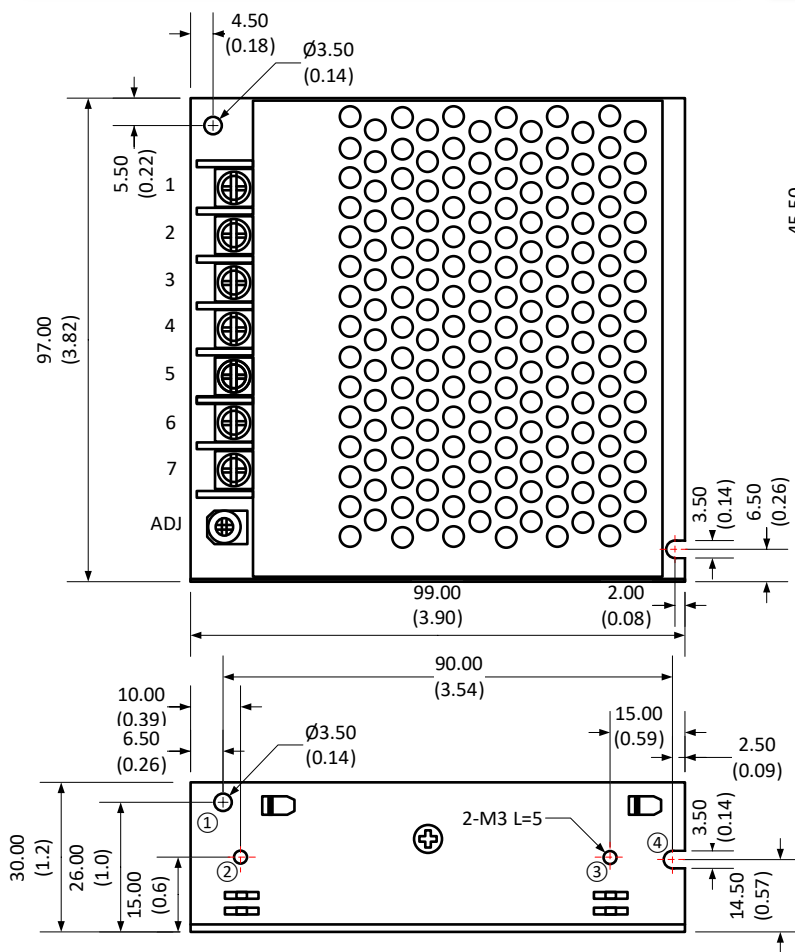

**Note:**

Unit: mm(inch)

Wire gauge: 22-12AWG

Screw terminal tightening torque: M3, 0.5N-m

Mounting screw tightening torque: M3, 0.4N-m

General tolerance:  $\pm 1.0(0.04)$

At least one of the ① - ⑧ location must be connected to PE

**Dual Pin Output Specifications**

Pin	Function
1	Input (L)
2	Input (N)
3	PE GND
4	-V Output 2
5	+V Output 2
6	-V Output 1
7	+V Output 1
ADJ	Vo1 voltage adj knob

**Triple Pin Output Specifications**

Pin	Function
1	Input (L)
2	Input (N)
3	PE GND
4	+V Output 3
5	+V Output 2
6	Common
7	+V Output 1
ADJ	Vo1 voltage adj knob

**NOTE:** 1. Datasheets are updated as needed and as such, specifications are subject to change without notice. Once printed or downloaded, datasheets are no longer controlled by Aimtec; refer to [www.aimtec.com](http://www.aimtec.com) for the most current product specifications. 2. Product labels shown, including safety agency certifications on labels, may vary based on the date manufactured. 3. Mechanical drawings and specifications are for reference only. 4. All specifications are measured at an ambient temperature of 25°C, humidity<75%, nominal input voltage and at rated output load unless otherwise specified. 5. Aimtec may not have conducted destructive testing or chemical analysis on all internal components and chemicals at the time of publishing this document. CAS numbers and other limited information are considered proprietary and may not be available for release. 6. This product is not designed for use in critical life support systems, equipment used in hazardous environments, nuclear control systems or other such applications which necessitate specific safety and regulatory standards other the ones listed in this datasheet. 7. Warranty is in accordance with Aimtec's standard Terms of Sale available at [www.aimtec.com](http://www.aimtec.com).