

REV.	Q'TY	ECN. NO.	APR.	DATE

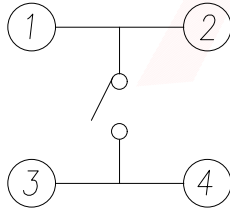

CIRCUIT DIAGRAM

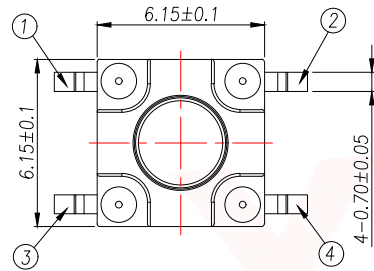
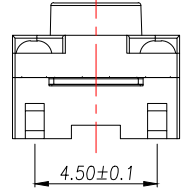
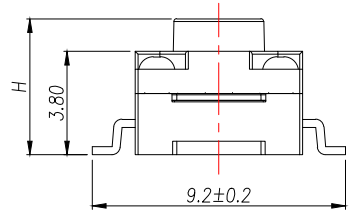
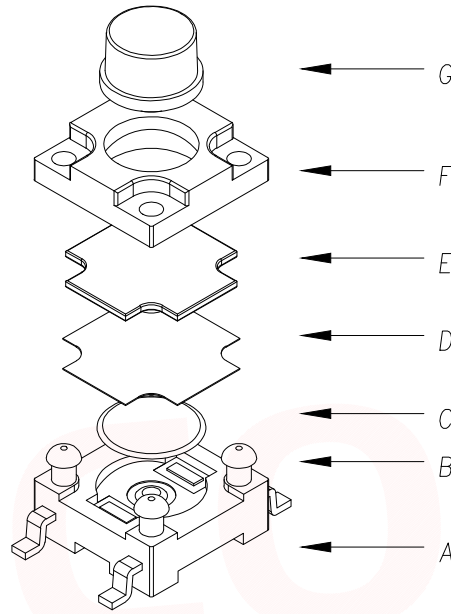
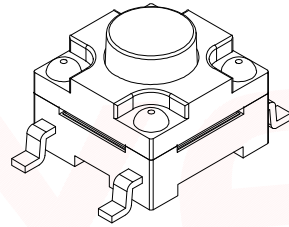

The Main Thchnology Performance

Rate voltage,current	50mA DC12V
Contact resistance	<100mΩ
Operating force	±30gf
Travel	0.30±0.10mm
Insulated resistance	>100MΩ
Dielectric strength	>250VAC/1min
IP rating	IP67

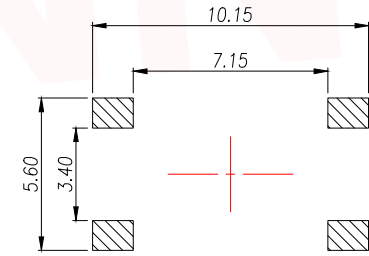

PCB.WELDING DRAWING

G	按钮	PPA	1	黑色
F	盖板	PPA	1	黑色
E	防尘膜	硅胶	1	黑色
D	防水层	聚酰亚胺	1	橙黄色
C	弹片	不锈钢	1	镀银
B	本体	PPA	1	黑色
A	卡件	黄铜	1	镀银
ITEM	DESCRIPTION	MATERIAL	QTY	FINISH/COLOR

T S O 1 7 A - T B Y 1

力度: F: 250G E: 180G
 高度: H4.3 H4.5

H	H	H
4.3	6.5	9.5
4.5	7.0	10.0
4.8	7.5	10.5
5.0	8.0	11.0
5.5	8.5	
6.0	9.0	

DIMENSION IN mm	
TOLERANCE UNLESS OTHERWISE SPECIFIED	
.X±0.35	X.*± 5°
.XX±0.25	.X.*± 3°
.XXX±0.15	.XX.*± 1°

厦门市辛译精密电子有限公司
 Xiamen XinYi Xyeconn Electronics Co.,Ltd

APR. Alex TITLE: 6x6 SMD TACT SWITCH

CHK. Jack DWG NO. TS017A-TBY1FHX

DRA. Can PROJ. CUSTOMER DRAWING

SIZE A4 SCALE 1:1 SHEET 1/1 REV. A