

102387-5 ✓ ACTIVE

AMPMODU | AMPMODU IV/V

TE Internal #: 102387-5

Housing, Receptacle, Wire-to-Board, 24 Position, .1 in [2.54 mm]

Centerline, Crimp, 2 Row, Black, Wire & Cable, Signal, AMPMODU IV/V

[View on TE.com >](#)



Connectors > PCB Connectors > Wire-to-Board Connectors > Wire-to-Board Connector Assemblies & Housings

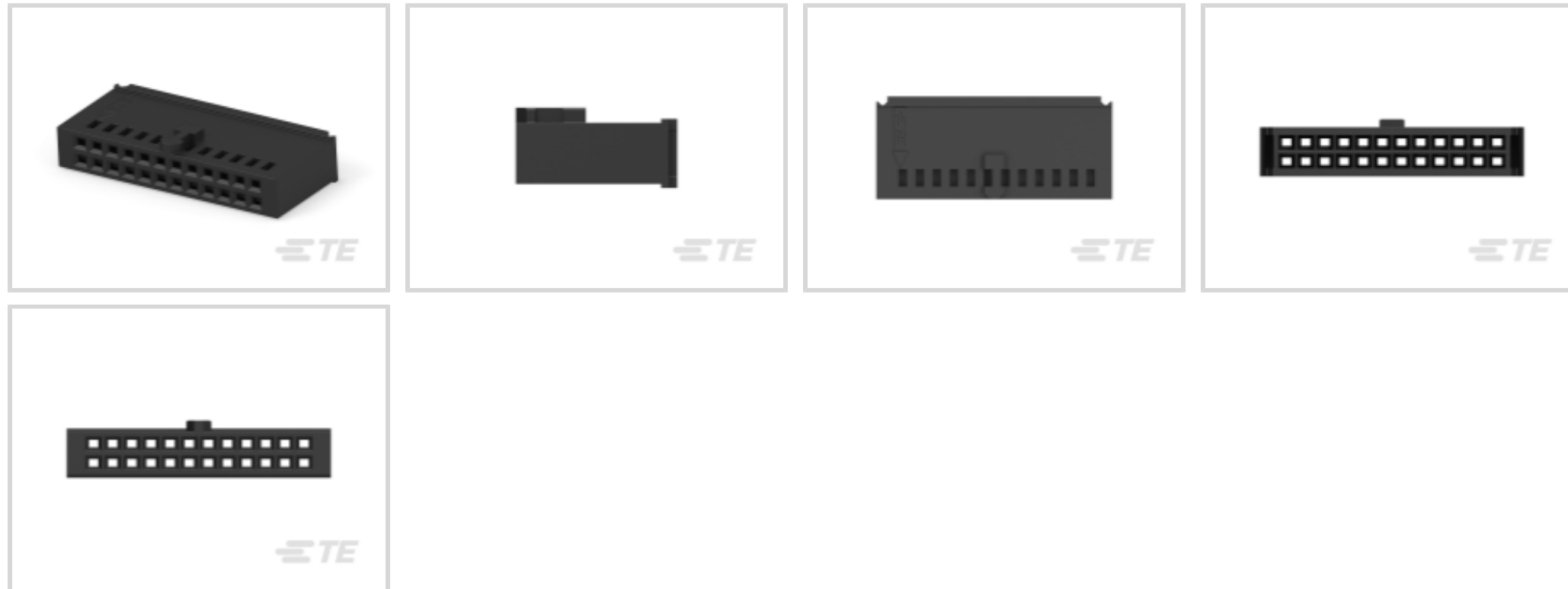

Connector Product Type: **Housing**

Connector & Housing Type: **Receptacle**

Connector System: **Wire-to-Board**

Number of Positions: **24**

Centerline (Pitch): **2.54 mm [.1 in]**

Features

Product Type Features

Connector Product Type	Housing
Connector & Housing Type	Receptacle
Connector System	Wire-to-Board
Connector & Contact Terminates To	Wire & Cable

Configuration Features

Number of Positions	24
Number of Rows	2

Electrical Characteristics

Termination Resistance	12 mΩ
Insulation Resistance	5000 MΩ
Dielectric Withstanding Voltage (Max)	750 V
Operating Voltage	250 VAC

Body Features

Primary Product Color	Black
-----------------------	-------



Contact Features

Contact Type	Socket
Contact Base Material	Beryllium Copper
Contact Current Rating (Max)	3 A

Termination Features

Termination Method to Wire & Cable	Crimp
------------------------------------	-------

Mechanical Attachment

Strain Relief	Without
Mating Retention	Without

Housing Features

Housing Entry Configuration	Both Ends Closed
Housing Material	Thermoplastic
Centerline (Pitch)	2.54 mm[.1 in]

Dimensions

Connector Length	35.05 mm[1.38 in]
Connector Height	7.23 mm[.285 in]
Row-to-Row Spacing	2.54 mm[.1 in]

Usage Conditions

Operating Temperature Range	-65 – 105 °C[-85 – 221 °F]
-----------------------------	----------------------------

Operation/Application

Circuit Application	Signal
---------------------	--------

Industry Standards

Glow Wire Rating	Standard Part - Not Glow Wire
Compatible With Approved Standards Products	CSA LR7189, UL E28476
UL Flammability Rating	UL 94V-0

Packaging Features

Packaging Quantity	1
Packaging Method	Package

Product Compliance

[For compliance documentation, visit the product page on TE.com>](#)



EU RoHS Directive 2011/65/EU	Compliant
EU ELV Directive 2000/53/EC	Compliant
China RoHS 2 Directive MIIT Order No 32, 2016	No Restricted Materials Above Threshold
EU REACH Regulation (EC) No. 1907/2006	Current ECHA Candidate List: JUNE 2023 (235) Candidate List Declared Against: JUNE 2023 (235) Does not contain REACH SVHC
Halogen Content	BFR/CFR/PVC Free, but Br/Cl >900 ppm in other sources.
Solder Process Capability	Not applicable for solder process capability

Product Compliance Disclaimer

This information is provided based on reasonable inquiry of our suppliers and represents our current actual knowledge based on the information they provided. This information is subject to change. The part numbers that TE has identified as EU RoHS compliant have a maximum concentration of 0.1% by weight in homogenous materials for lead, hexavalent chromium, mercury, PBB, PBDE, DBP, BBP, DEHP, DIBP, and 0.01% for cadmium, or qualify for an exemption to these limits as defined in the Annexes of Directive 2011/65/EU (RoHS2). Finished electrical and electronic equipment products will be CE marked as required by Directive 2011/65/EU. Components may not be CE marked. Additionally, the part numbers that TE has identified as EU ELV compliant have a maximum concentration of 0.1% by weight in homogenous materials for lead, hexavalent chromium, and mercury, and 0.01% for cadmium, or qualify for an exemption to these limits as defined in the Annexes of Directive 2000/53/EC (ELV). Regarding the REACH Regulation, the information TE provides on SVHC in articles for this part number is based on the latest European Chemicals Agency (ECHA) 'Guidance on requirements for substances in articles' posted at this URL: <https://echa.europa.eu/guidance-documents/guidance-on-reach>

Compatible Parts



TE Part # CAT-AM74-UN384H
AMP-LATCH UNIVERSAL HEADERS



TE Part # 1-5103308-3
A/L LOW PRO HDR 24P VERT BLACK



TE Part # 87666-2
MOD IV RECP PLTD 30 SEL



TE Part # 87756-6
MOD IV RECP PLTD SN



TE Part # 2-87195-4
MOD IV RECP PLTE 15 DPLX



TE Part # 87809-1
MOD V RECP PLTD 30 AU



TE Part # 6-87756-2
MOD IV RECP PLTD 15 DPLX LF



TE Part # 87309-9
MOD V RECP PLTD 30 AU

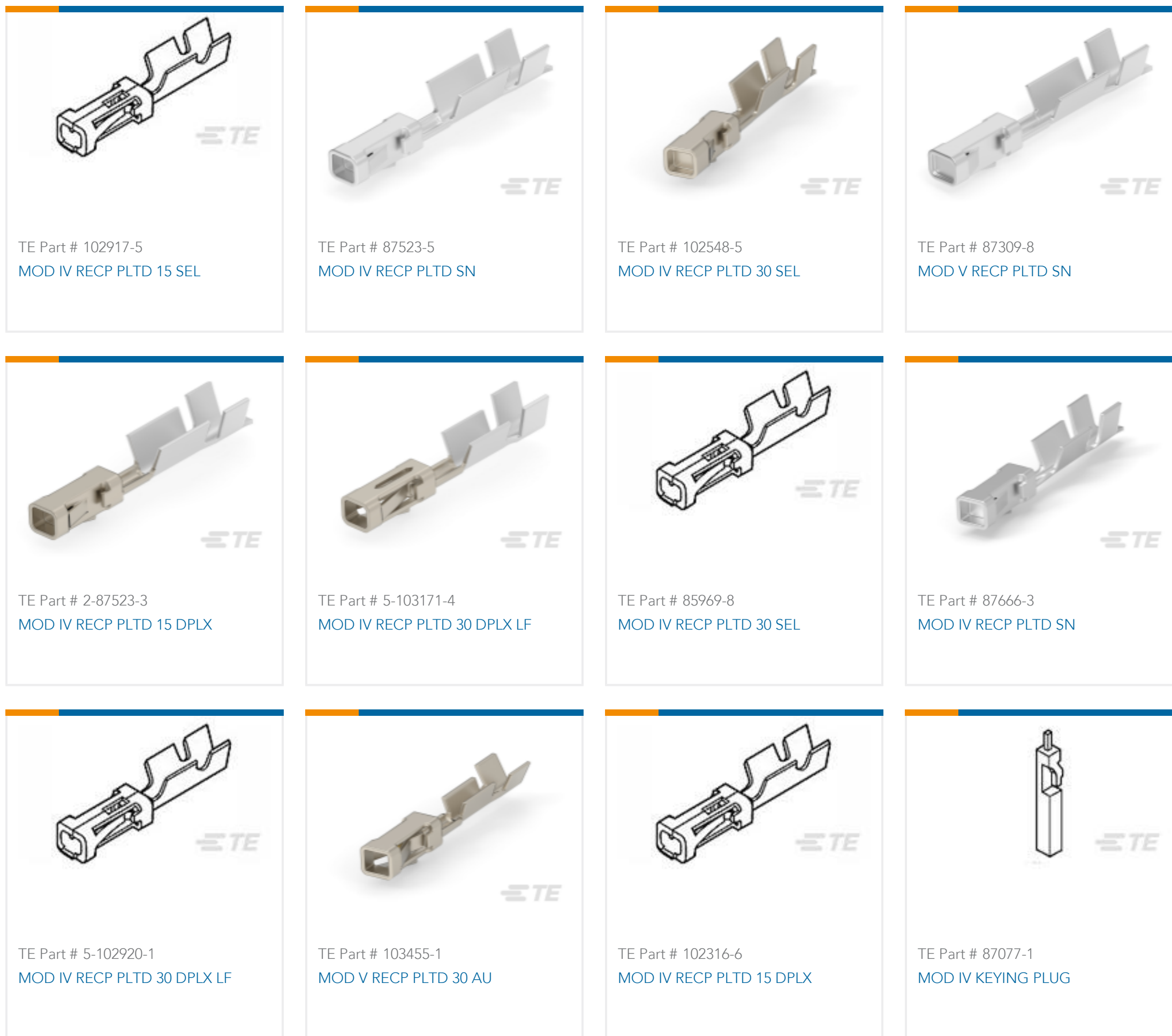

Also in the Series | AMPMODU IV/V

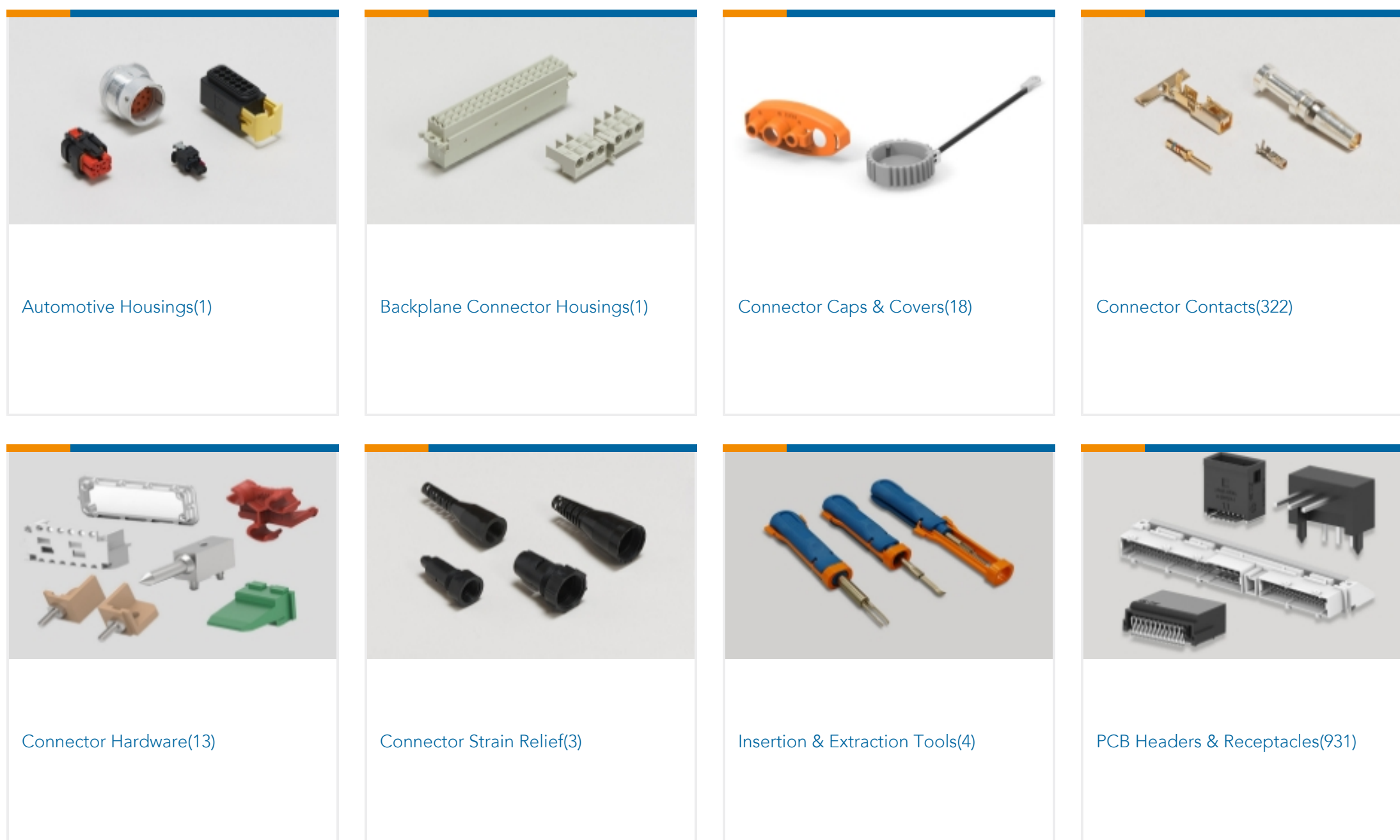



Rectangular Connector Housings(5)

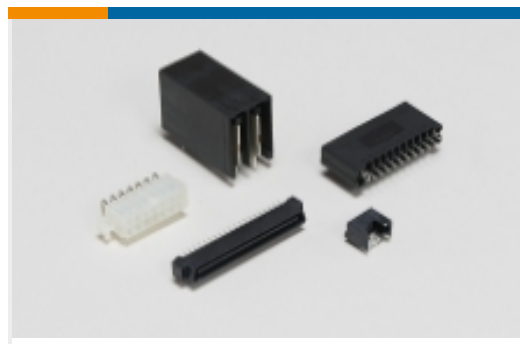

Standard Rectangular Connectors(8)

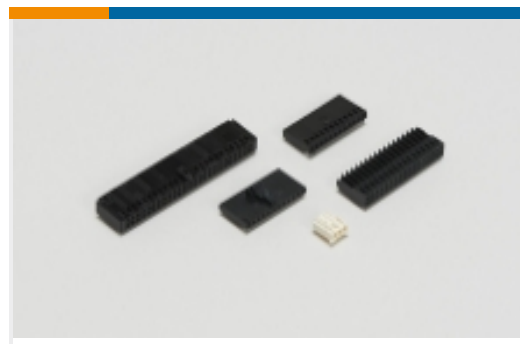

Wire-to-Board Connector Assemblies & Housings(444)

Customers Also Bought



TE Part #745254-2
20DF PIN CONTACT,PLATED



TE Part #102387-7
30 MODIV HSG COMP DR .100 POL

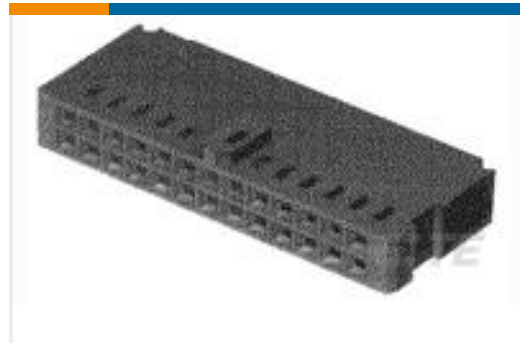

TE Part #102387-4
20 MODIV HSG COMP DR .100 POL



TE Part #2-2316102-0
20P,2MM,REC,HSG,SR,CRIMP,PLAIN, BOX



TE Part #1-2176337-2
CRGCQ 0402 82R 1%



TE Part #7-2176391-7
RQ 1206 76K8 0.1% 10PPM 5K RL

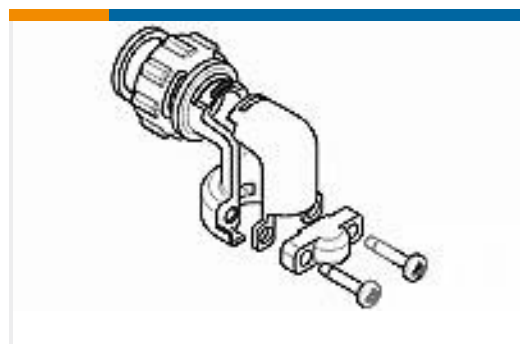

TE Part #1546347-2
R/A CABLE CLAMP KIT,SZ 11,CPC



TE Part #1735447-9
HPI 2.0 RECEPTACLE HOUSING, 9P

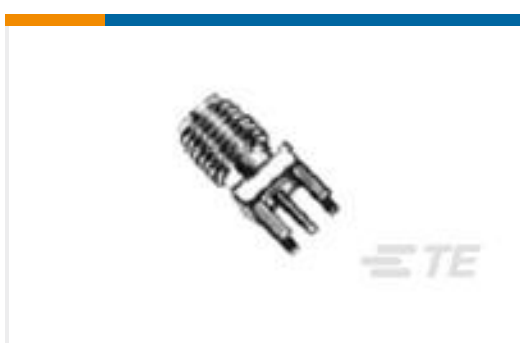

TE Part #1045672-1
1062 0000 00



TE Part #61-0108-011-000
CONTACT PIN 2 MM

Documents

CAD Files

Customer View Model

[ENG_CVM_CVM_102387-5_AC.2d_dxf.zip](#)

English

3D PDF

3D

Customer View Model

[ENG_CVM_CVM_102387-5_AC.3d_igs.zip](#)



English

Customer View Model

[ENG_CVM_CVM_102387-5_AC.3d_stp.zip](#)

English

By downloading the CAD file I accept and agree to the [Terms and Conditions](#) of use.

Datasheets & Catalog Pages

[AMPMODU_INTERCONNECTION_SYSTEM_SECTION5_CONT](#)

English

Product Specifications

[Product Specification](#)

English

Agency Approvals

[UL](#)

English