

1393365-2 ✓ ACTIVE

AMP | [Get .64 Connector System](#)

TE Internal #: 1393365-2

Automotive Terminals, Receptacle, Mating Tab Width 1 mm [.039 in], Tab Thickness .64 mm [.025 in], 20 – 18 AWG Wire Size, Get .64 Connector System

[View on TE.com >](#)



Terminals & Splices > Automotive Terminals > GET .64 CONNECTOR SYSTEM, RECEPT AND TAB



Terminal Type: **Receptacle**

Mating Tab Width: **1 mm [.039 in]**

Mating Tab Thickness: **.64 mm [.025 in]**

Terminal Transmits: **0 – 24 A (Low Power)**

Wire Size: **20 – 18 AWG**

[All GET .64 CONNECTOR SYSTEM, RECEPT AND TAB \(28\)](#)

Features

Product Type Features

Receptacle Style	180°
Sealable	No
Primary Locking Feature	Clean Body

Contact Features

Contact Size	.64mm
Contact Fabrication	Stamped & Formed
Wire Contact Termination Area Plating Material	Tin
Typical Current Rating	1 A
Crimp Type	F-Crimp
Terminal Type	Receptacle
Mating Tab Width	1 mm [.039 in]
Mating Tab Thickness	.64 mm [.025 in]
Interface Plating	Tin (Sn)

Termination Features

Termination Method to Wire & Cable	Crimp
Product Terminates To	Wire



Dimensions

Compatible Insulation Diameter Range	1.6 – 1.9 mm [.055 – .081 in]
Wire Size	.5 – .75 mm ²
Wire Size Search	18 AWG, 19 AWG, 20 AWG

Usage Conditions

Insulation Option	Uninsulated
Operating Temperature (Max)	80 °C, 85 °C, 90 °C, 100 °C, 105 °C, 110 °C, 120 °C, 125 °C, 130 °C, 140 °C, 145 °C, 150 °C [176 °F][185 °F][194 °F][212 °F][221 °F][230 °F][248 °F][257 °F][266 °F][284 °F][293 °F][302 °F]
Operating Temperature Range	-40 – 150 °C [-40 – 302 °F]

Operation/Application

Compatible With Wire Base Material	Copper
------------------------------------	--------

Packaging Features

Packaging Quantity	10000
Packaging Method	Reel

Other

Terminal Transmits	0 – 24 A (Low Power)
--------------------	----------------------

Product Compliance

[For compliance documentation, visit the product page on TE.com>](#)

EU RoHS Directive 2011/65/EU	Compliant
EU ELV Directive 2000/53/EC	Compliant
China RoHS 2 Directive MIIT Order No 32, 2016	No Restricted Materials Above Threshold
EU REACH Regulation (EC) No. 1907/2006	Current ECHA Candidate List: JUNE 2023 (235) Candidate List Declared Against: JUNE 2023 (235) Does not contain REACH SVHC
Halogen Content	Low Halogen - Br, Cl, F, I < 900 ppm per homogenous material. Also BFR/CFR/PVC Free
Solder Process Capability	Not applicable for solder process capability

Product Compliance Disclaimer



This information is provided based on reasonable inquiry of our suppliers and represents our current actual knowledge based on the information they provided. This information is subject to change. The part numbers that TE has identified as EU RoHS compliant have a maximum concentration of 0.1% by weight in homogenous materials for lead, hexavalent chromium, mercury, PBB, PBDE, DBP, BBP, DEHP, DIBP, and 0.01% for cadmium, or qualify for an exemption to these limits as defined in the Annexes of Directive 2011/65/EU (RoHS2). Finished electrical and electronic equipment products will be CE marked as required by Directive 2011/65/EU. Components may not be CE marked. Additionally, the part numbers that TE has identified as EU ELV compliant have a maximum concentration of 0.1% by weight in homogenous materials for lead, hexavalent chromium, and mercury, and 0.01% for cadmium, or qualify for an exemption to these limits as defined in the Annexes of Directive 2000/53/EC (ELV). Regarding the REACH Regulation, the information TE provides on SVHC in articles for this part number is based on the latest European Chemicals Agency (ECHA) 'Guidance on requirements for substances in articles' posted at this URL: <https://echa.europa.eu/guidance-documents/guidance-on-reach>

Compatible Parts



TE Part # CAT-G3353-CH8172
GET .64 CONNECTOR SYSTEM,
CONNECTOR HSG



TE Part # 1438299-3
GET MALE TERM, B, AU, REREEL



TE Part # 2278398-1
3WAY GET 0.64 SEAL PLUG



TE Part # 2151539-1
OCEAN-2.0-APPLICATOR-S-
070F068SP



TE Part # 1411001-6
SEALED HARN ASSY W CPA KEY B



TE Part # 2203663-6
2X9 SEALED PLUG ASSY KEY B



TE Part # 1924639-2
1X8 FEMALE ASSY KEY D, LP LATC



TE Part # 1411001-7
2x4 SEALED HARN ASSY W/O CPA



TE Part # 2151539-2
OCEAN-2.0-APPLICATOR-S-
070F068SP



TE Part # 2272431-4
1X6 GET UNSLD SIDE LATCH PLUG,
KEY D



TE Part # 2305570-1
Strip Terminal Cutter-Side Feed-No
Crimp



TE Part # 7-2151539-1
OCEAN-2.0-APPLICATOR-S-
070F068SP



TE Part # 7-2151539-2
OCEAN-2.0-APPLICATOR-S-
070F068SP



KIT
TE Part # 7-2151539-7
OCEAN_2.0_SPARE_PART_KIT-
070F068SP

TE Part # 1-1411001-6
8POS,GET 0.64,REC HSG ASSY,SLD

TE Part # 1-1411001-7
8POS,GET 0.64,REC HSG ASSY,SLD



TE Part # 1-1411001-8
8POS,GET 0.64,REC HSG ASSY,SLD



TE Part # 1438734-6
GET FEMALE, BLANK, PLT AU/AU B CRIMP



TE Part # 1897132-3
MULTI SPRING(M) AS STAMP



TE Part # 1897132-4
MULTI SPRING(M) FOR ACU 66P

Also in the Series | Get .64 Connector System



Automotive Connector Caps & Covers (3)



Automotive Housings(88)



Automotive Terminals(29)



Insertion & Extraction Tools(1)



PCB Headers & Receptacles(1)

Customers Also Bought



TE Part #1438136-1
70 WAY HARNESS ASSY KEYA(PROD)



TE Part #1241408-1
AMP MCP, RECEPTACLE AND TAB



TE Part #967542-1
AMP MCP, SFC, RECEPTACLE



TE Part #5-968220-5
MQS, RECEPTACLE AND TAB

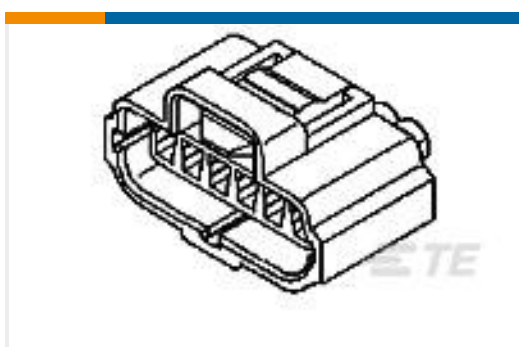

TE Part #184060-1
6 POS./6 CIRC PLUG ASSY, KEY A



TE Part #1-2236269-1
24POS, MIXED,REC HSG, 20GENYMCP,ASSY,CODA



TE Part #2236269-2
24POS, MIXED,REC HSG, 20GENYMCP,ASSY,CODB



Documents

Product Drawings

[V23540X7000Y 22=GET-FEM TERM A](#)

English

CAD Files

3D PDF

3D

Customer View Model

[ENG_CVM_CVM_1393365-2_A.2d_dxf.zip](#)

English

Customer View Model

[ENG_CVM_CVM_1393365-2_A.3d_igs.zip](#)

English

Customer View Model

[ENG_CVM_CVM_1393365-2_A.3d_stp.zip](#)

English

By downloading the CAD file I accept and agree to the [Terms and Conditions](#) of use.

Datasheets & Catalog Pages

[GET 0.64 Interconnection System](#)

English

Product Specifications

[Application Specification](#)

English

[Application Specification](#)

English