



MATE-N-LOK | Commercial MATE-N-LOK

TE Internal #: 163302-6

Socket Contact, Tin, Locking Lance Contact Retention, 17 – 13 AWG Wire Size, 1 – 2.5 mm² Wire Size, Crimp, Brass, Power, Commercial MATE-N-LOK

[View on TE.com >](#)

Connectors > Contacts > Connector Contacts



Contact Type: **Socket**

Contact Mating Area Plating Material: **Tin**

Wire Contact Termination Area Plating Material: **Tin-Lead**

Contact Retention Within Housing: **With**

Contact Retention Type Within Housing: **Locking Lance**

Features

Product Type Features

Discrete Wire Type	Stranded
--------------------	----------

Contact Features

Mating Pin Diameter	2.1 mm[.082 in]
Wire Contact Termination Area Plating Material Finish	Bright
Contact Orientation	Straight
Contact Type	Socket
Contact Mating Area Plating Material	Tin
Wire Contact Termination Area Plating Material	Tin-Lead
Contact Retention Within Housing	With
Contact Base Material	Brass

Termination Features

Termination Method to Wire & Cable	Crimp
Product Terminates To	Wire & Cable

Mechanical Attachment



Wire Insulation Support	Without
Contact Retention Type Within Housing	Locking Lance

Dimensions

Compatible Insulation Diameter Range	2.5 – 3.8 mm [.098 – .15 in]
Wire Size	1 – 2.5 mm ²

Operation/Application

Circuit Application	Power
---------------------	-------

Packaging Features

Packaging Quantity	3500
Packaging Method	Reel

Product Compliance

For compliance documentation, visit the product page on [TE.com](https://www.te.com)>

EU RoHS Directive 2011/65/EU	Compliant
EU ELV Directive 2000/53/EC	Compliant
China RoHS 2 Directive MIIT Order No 32, 2016	No Restricted Materials Above Threshold
EU REACH Regulation (EC) No. 1907/2006	Current ECHA Candidate List: JUNE 2023 (235) Candidate List Declared Against: JUNE 2023 (235) Does not contain REACH SVHC
Halogen Content	Low Halogen - Br, Cl, F, I < 900 ppm per homogenous material. Also BFR/CFR/PVC Free
Solder Process Capability	Not applicable for solder process capability

Product Compliance Disclaimer

This information is provided based on reasonable inquiry of our suppliers and represents our current actual knowledge based on the information they provided. This information is subject to change. The part numbers that TE has identified as EU RoHS compliant have a maximum concentration of 0.1% by weight in homogenous materials for lead, hexavalent chromium, mercury, PBB, PBDE, DBP, BBP, DEHP, DIBP, and 0.01% for cadmium, or qualify for an exemption to these limits as defined in the Annexes of Directive 2011/65/EU (RoHS2). Finished electrical and electronic equipment products will be CE marked as required by Directive 2011/65/EU. Components may not be CE marked. Additionally, the part numbers that TE has identified as EU ELV compliant have a maximum concentration of 0.1% by weight in homogenous materials for lead, hexavalent chromium, and mercury, and 0.01% for cadmium, or qualify for an exemption to these limits as defined in the Annexes of Directive 2000/53/EC (ELV). Regarding the REACH Regulation, the information TE provides on SVHC in articles for this part number is based on the latest European Chemicals Agency (ECHA) 'Guidance on requirements for substances in articles' posted at this URL: <https://echa.europa.eu/guidance-documents/guidance-on-reach>



Compatible Parts



TE Part # 91504-1
CCII CMNL MNL PIN SKT 20-14 ASSY



TE Part # 465644-1
EXTRACTION TOOL



TE Part # 1-171196-0
6 POS MATE-N-LOK S



TE Part # 1-480274-0
09P CMNL PLUG HSG P/M NATL



TE Part # 1-480284-0
08P CMNL CAP HSG M/M NATL



TE Part # 1-480438-0
16P CMNL PLUG HSG M/M NATL



TE Part # 1-480683-0
02P CMNL PLUG HSG F/H NATL



TE Part # 1-480277-0
09P CMNL CAP HSG P/M NATL



TE Part # 1-480304-0
03P CMNL PLUG HSG P/M NATL



TE Part # 1-480722-0
04P CMNL PLUG HSG W/LCK NATL



TE Part # 1-480276-0
06P CMNL CAP HSG P/M NATL



TE Part # 1-480285-0
10P CMNL PLUG HSG M/M NATL



TE Part # 1-480439-0
16P CMNL CAP HSG M/M NATL



TE Part # 1-480393-1
02P CMNL PLUG HSG F/H BLK



TE Part # 1-480345-0
08P CMNL CAP HSG F/H NATL



TE Part # 1-480340-0
06P CMNL CAP HSG F/H NATL



TE Part # 1-480278-0
12P CMNL CAP HSG P/M NATL



TE Part # 1-480324-0
15P CMNL CAP HSG P/M NATL



TE Part # 1-480721-0
03P CMNL PLUG HSG W/LOK NATL



TE Part # 1-480323-0
15P CMNL PLUG HSG P/M NATL

Also in the Series | Commercial MATE-N-LOK

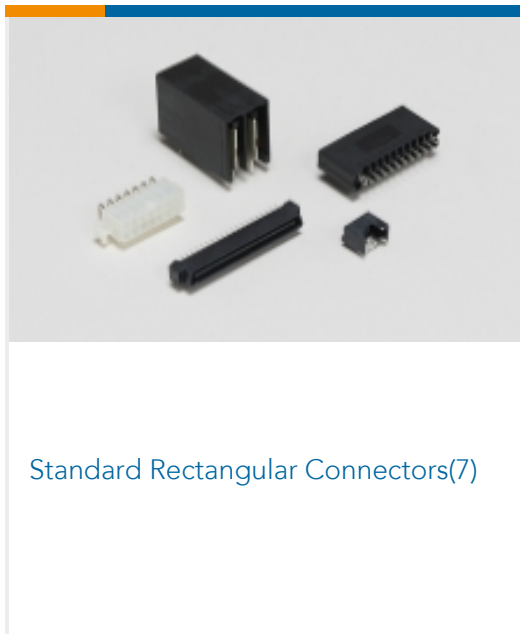
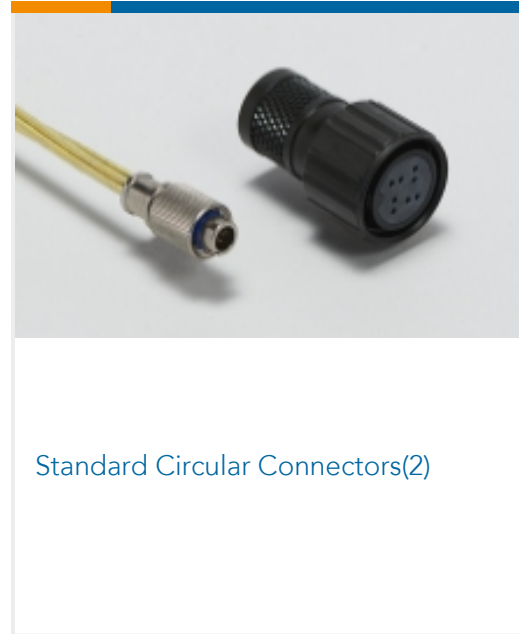
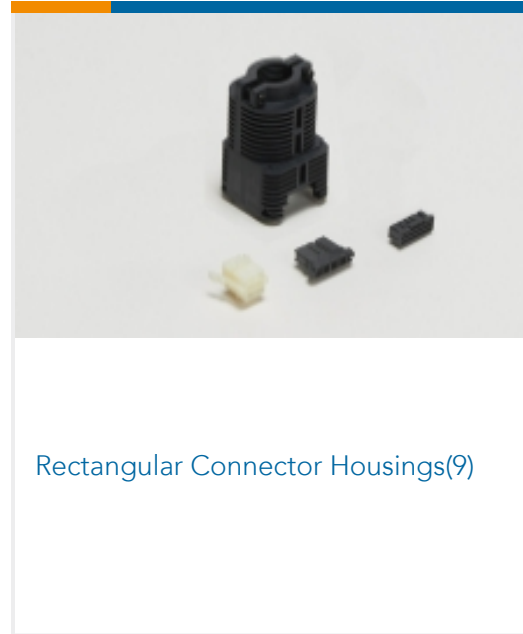
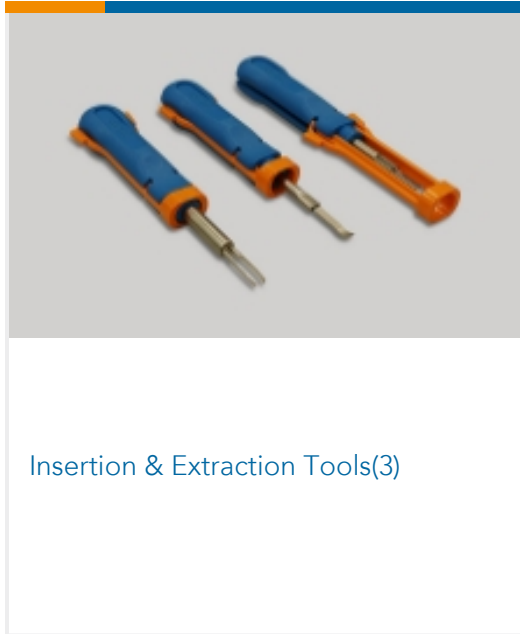
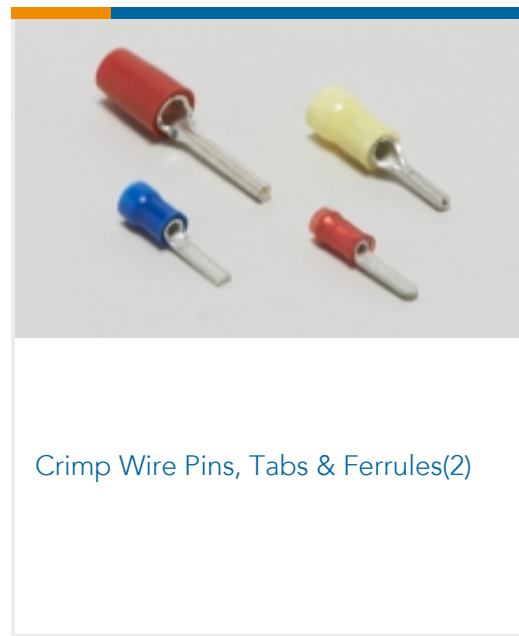
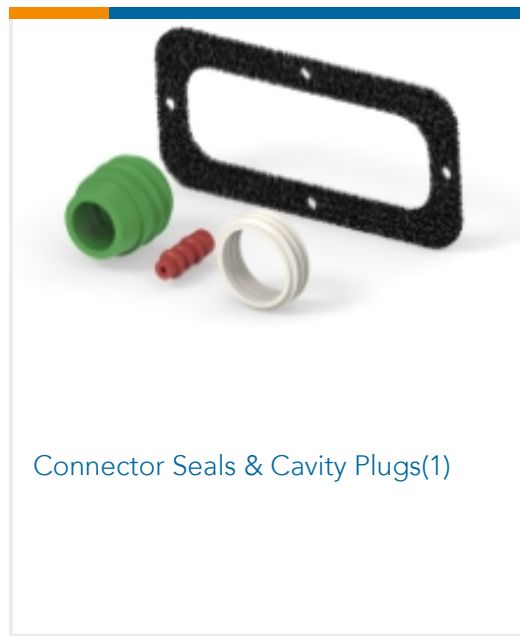
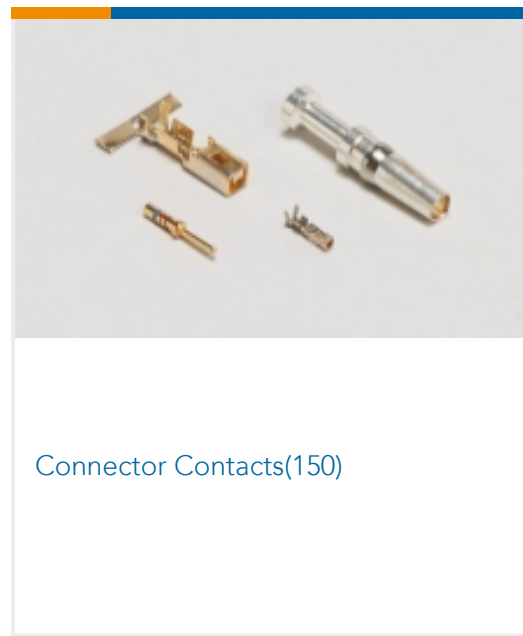

Customers Also Bought

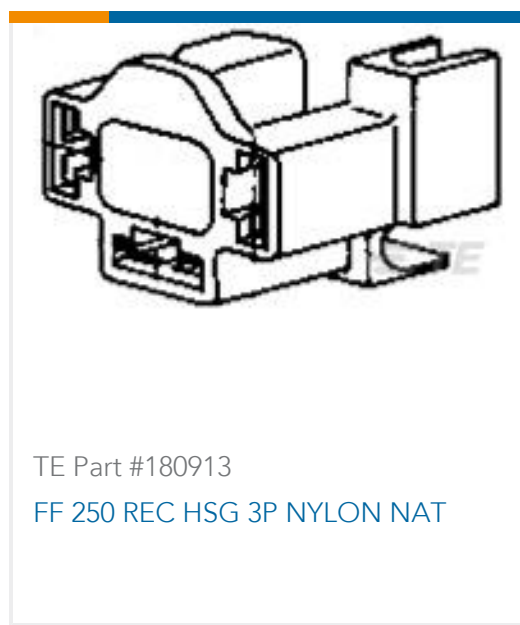



Documents

Product Drawings

MATENLOK SIDE WAY

English

CAD Files

3D PDF

3D

Customer View Model

[ENG_CVM_CVM_163302-6_W.2d_dxf.zip](#)

English

Customer View Model

[ENG_CVM_CVM_163302-6_W.3d_igs.zip](#)

English

Customer View Model

[ENG_CVM_CVM_163302-6_W.3d_stp.zip](#)

English

3D PDF

English

Customer View Model

[ENG_CVM_163302-6_E.3d_igs.zip](#)

English

Customer View Model

[ENG_CVM_163302-6_E.3d_stp.zip](#)

English

Customer View Model

[ENG_CVM_163302-6_E.2d_dxf.zip](#)

English

By downloading the CAD file I accept and agree to the [Terms and Conditions](#) of use.

Product Specifications

Application Specification

English