

213847-1 ✓ ACTIVE

AMP | AMP POWERBAND

TE Internal #: 213847-1

Socket Contact, Silver, 600 VAC, 600 VDC, Snap-In Contact

Retention, Size 8 Contact Size, 14 – 12 AWG Wire Size, 2 – 3 mm²

Wire Size, AMP POWERBAND

[View on TE.com >](#)



Connectors > Contacts > Connector Contacts > POWERBAND Contacts



Contact Type: **Socket**

Contact Mating Area Plating Material: **Silver**

Wire Contact Termination Area Plating Material: **Silver**

Operating Voltage: **600 VDC**

[All POWERBAND Contacts \(20\)](#)

Features

Product Type Features

Discrete Wire Type	Stranded
Sealable	No

Electrical Characteristics

Operating Voltage	600 VDC
-------------------	---------

Contact Features

Mating Pin Diameter	3.18 mm[.125 in]
Contact Underplating Material Thickness	2 – 3 μm[50 μin]
Wire Contact Termination Area Plating Thickness	1.27 μm[50 μin]
Wire Contact Termination Area Plating Material Finish	Semi-Bright
Contact Mating Area Plating Material Thickness	2 – 3 μm[2 – 3 μin]
Contact Mating Area Plating Material Finish	Semi-Bright
Contact Orientation	Straight
Contact Underplating Material	Nickel



Contact Type	Socket
Contact Mating Area Plating Material	Silver
Wire Contact Termination Area Plating Material	Silver
Contact Retention Within Housing	With
Contact Size	Size 8
Contact Base Material	Copper
Contact Current Rating (Max)	50 A

Termination Features

Termination Method to Wire & Cable	Crimp
Product Terminates To	Wire & Cable

Mechanical Attachment

Wire Insulation Support	Without
Contact Retention Type Within Housing	Snap-In

Dimensions

Wire Size	2 – 3 mm ²
-----------	-----------------------

Usage Conditions

Operating Temperature Range	-55 – 105 °C[-67 – 221 °F]
-----------------------------	----------------------------

Operation/Application

Circuit Application	Power
---------------------	-------

Packaging Features

Packaging Quantity	1500
Packaging Method	Reel

Product Compliance

[For compliance documentation, visit the product page on TE.com>](#)

EU RoHS Directive 2011/65/EU	Compliant
EU ELV Directive 2000/53/EC	Compliant
China RoHS 2 Directive MIIT Order No 32, 2016	No Restricted Materials Above Threshold
EU REACH Regulation (EC) No. 1907/2006	Current ECHA Candidate List: JUNE 2023 (235) Candidate List Declared Against: JUNE 2023 (235) Does not contain REACH SVHC













Halogen Content	Low Halogen - Br, Cl, F, I < 900 ppm per homogenous material. Also BFR/CFR/PVC Free
Solder Process Capability	Not applicable for solder process capability

Product Compliance Disclaimer

This information is provided based on reasonable inquiry of our suppliers and represents our current actual knowledge based on the information they provided. This information is subject to change. The part numbers that TE has identified as EU RoHS compliant have a maximum concentration of 0.1% by weight in homogenous materials for lead, hexavalent chromium, mercury, PBB, PBDE, DBP, BBP, DEHP, DIBP, and 0.01% for cadmium, or qualify for an exemption to these limits as defined in the Annexes of Directive 2011/65/EU (RoHS2). Finished electrical and electronic equipment products will be CE marked as required by Directive 2011/65/EU. Components may not be CE marked. Additionally, the part numbers that TE has identified as EU ELV compliant have a maximum concentration of 0.1% by weight in homogenous materials for lead, hexavalent chromium, and mercury, and 0.01% for cadmium, or qualify for an exemption to these limits as defined in the Annexes of Directive 2000/53/EC (ELV). Regarding the REACH Regulation, the information TE provides on SVHC in articles for this part number is based on the latest European Chemicals Agency (ECHA) 'Guidance on requirements for substances in articles' posted at this URL: <https://echa.europa.eu/guidance-documents/guidance-on-reach>

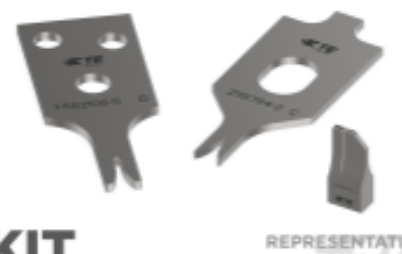
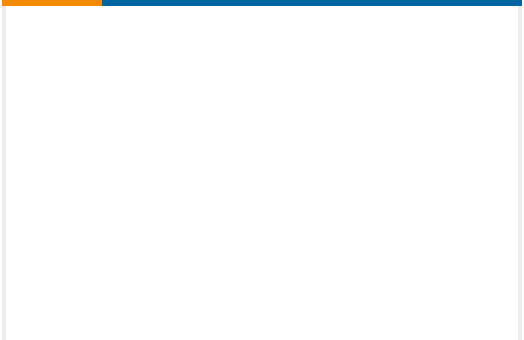
Compatible Parts

 <p>TE Part # CAT-AM71-C83998U Environmentally Sealed Circular Connector, CPC Series 5</p>	 <p>TE Part # CAT-AM71-C83998K Circular Connector, Environmentally Sealed, CPC Series 6</p>	 <p>TE Part # 213906-1 CPC PLUG ASSY,SRS 6,SZ 17-10</p>	 <p>TE Part # 213900-1 CPC SEAL ASSY KIT,SRS 6,17-10</p>
 <p>TE Part # 318813-1 EXTRACTION TOOL ASSY</p>	 <p>TE Part # 213899-1 CPC SEAL ASSY KIT,SRS 5,17-3</p>	 <p>TE Part # 2836120-2 OCEAN-2.0-APPLICATOR-S-130F</p>	 <p>TE Part # 7-2836120-2 OCEAN-2.0-APPLICATOR-S-130F</p>
 <p>KIT TE Part # 7-2836120-7 OCEAN_2.0_SPARE_PART_KIT-130F</p>	 <p>TE Part # 197889-1 ANVIL HOLDER</p>	 <p>TE Part # 680195-3 HDM 55MPR130F G</p>	

Also in the Series | **AMP POWERBAND**



Connector Contacts(20)

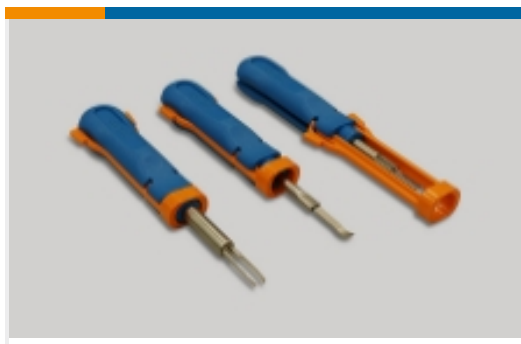

Insertion & Extraction Tools(1)

Customers Also Bought



TE Part #213905-1
Environmentally Sealed Circular Connector, CPC Series 5

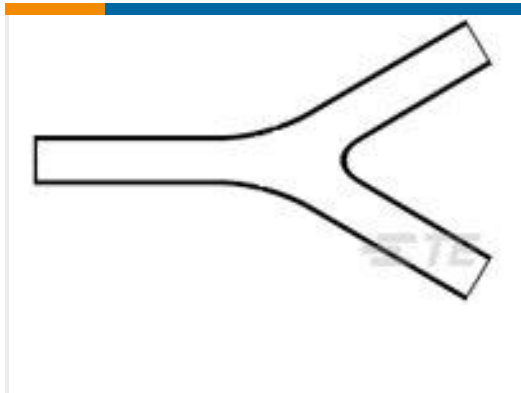

TE Part #820182-000
381A301-71-0



TE Part #745508-4
FERRULE SPLIT RING, HD



TE Part #170262-4
EIS CONNECTOR FORMING



TE Part #213890-2
CPC RECPT SEALED SIZE 17-3

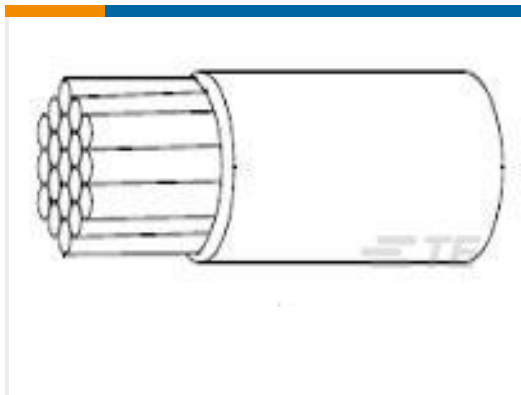

TE Part #216252-002
55A0111-12-5



TE Part #NB12724001
RNF-100-1/2-BK-FSP



TE Part #130519
TERM, SOLIS, SPADE, 22-16, M4(8)

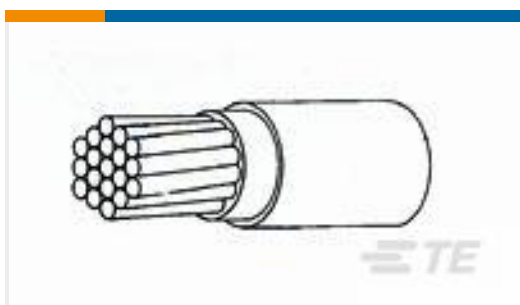

TE Part #282431-008
44A0111-12-5

Documents

Product Drawings

[POWERBAND CONT ASSY,SILVER PLT](#)

English

CAD Files

[3D PDF](#)

English

Customer View Model

[ENG_CVM_213847-1_B.3d_igs.zip](#)



English

Customer View Model

[ENG_CVM_213847-1_B.3d_stp.zip](#)

English

Customer View Model

[ENG_CVM_213847-1_B.2d_dxf.zip](#)

English

3D PDF

3D

Customer View Model

[ENG_CVM_CVM_213847-1_G.2d_dxf.zip](#)

English

Customer View Model

[ENG_CVM_CVM_213847-1_G.3d_igs.zip](#)

English

Customer View Model

[ENG_CVM_CVM_213847-1_G.3d_stp.zip](#)

English

By downloading the CAD file I accept and agree to the [Terms and Conditions](#) of use.

Datasheets & Catalog Pages

[AMP Circular Connectors for Commercial Signal & Power Applications](#)

English

[Power Contacts](#)

English

[METRIMATE_PIN_SOCKET_CATALOG](#)

English

Product Specifications

[Application Specification](#)

English

Agency Approvals

[Agency Approval Document](#)

English