

1241416-3 ✓ ACTIVE

AMP | AMP MCP Connector System

TE Internal #: 1241416-3

Automotive Terminals, Receptacle, Mating Tab Width 6.3 mm / 4.8 mm / 5.8 mm [.248 in / .189 in / .228 in], AMP MCP Connector System

[View on TE.com >](#)



Terminals & Splices > Automotive Terminals > AMP MCP, RECEPTACLE AND TAB



Terminal Type: **Receptacle**

Mating Tab Width: 4.8 mm, 5.8 mm, 6.3 mm [.189 in, .228 in, .248 in]

Mating Tab Thickness: .8 mm [.031 in]

Terminal Transmits: 25 – 40 A (Power)

Wire Size: 12 – 11 AWG

[All AMP MCP, RECEPTACLE AND TAB \(124\)](#)

### Features

#### Product Type Features

Receptacle Style	180°
Sealable	Yes
Primary Locking Feature	Locking Lance

#### Body Features

Terminal Seal Type	Single Wire Seal (SWS)
--------------------	------------------------

#### Contact Features

Contact Size	4.8mm, 6.3mm
Contact Fabrication	Stamped & Formed
Wire Contact Termination Area Plating Material	Tin
Typical Current Rating	30 A
Crimp Type	F-Crimp
Terminal Type	Receptacle



Mating Tab Width	4.8 mm, 5.8 mm, 6.3 mm [.189 in][.228 in][.248 in]
Mating Tab Thickness	.8 mm [.031 in]
Interface Plating	Silver (Ag)

### Termination Features

Termination Method to Wire & Cable	Crimp
Product Terminates To	Wire

### Dimensions

Compatible Insulation Diameter Range	3.4 – 4.4 mm [.132 – .172 in]
Wire Size	3 – 4 mm <sup>2</sup>
Wire Size Search	11 AWG, 12 AWG

### Usage Conditions

Insulation Option	Uninsulated
Operating Temperature (Max)	80 °C, 85 °C, 90 °C, 100 °C, 105 °C, 110 °C, 120 °C, 125 °C, 130 °C, 140 °C [176 °F][185 °F][194 °F][212 °F][221 °F][230 °F][248 °F][257 °F][266 °F][284 °F]
Operating Temperature Range	-40 – 140 °C [-40 – 284 °F]

### Operation/Application

Conforms to KOMAX Automatic Component Insertion Guideline	Yes, per Version 5.0 (March 2018)
Compatible With Wire Base Material	Copper

### Industry Standards

Compatible With Agency/Standards Products	LV214
---	-------

### Packaging Features

Packaging Quantity	1500
Packaging Method	Reel

### Other

Terminal Transmits	25 – 40 A (Power)
--------------------	-------------------

### Product Compliance

[For compliance documentation, visit the product page on TE.com>](#)

EU RoHS Directive 2011/65/EU	Compliant
EU ELV Directive 2000/53/EC	Compliant



China RoHS 2 Directive MIIT Order No 32, 2016	No Restricted Materials Above Threshold
EU REACH Regulation (EC) No. 1907/2006	Current ECHA Candidate List: JUNE 2023 (235) Candidate List Declared Against: JUNE 2023 (235) Does not contain REACH SVHC
Halogen Content	Low Halogen - Br, Cl, F, I < 900 ppm per homogenous material. Also BFR/CFR/PVC Free
Solder Process Capability	Not applicable for solder process capability

Product Compliance Disclaimer

This information is provided based on reasonable inquiry of our suppliers and represents our current actual knowledge based on the information they provided. This information is subject to change. The part numbers that TE has identified as EU RoHS compliant have a maximum concentration of 0.1% by weight in homogenous materials for lead, hexavalent chromium, mercury, PBB, PBDE, DBP, BBP, DEHP, DIBP, and 0.01% for cadmium, or qualify for an exemption to these limits as defined in the Annexes of Directive 2011/65/EU (RoHS2). Finished electrical and electronic equipment products will be CE marked as required by Directive 2011/65/EU. Components may not be CE marked. Additionally, the part numbers that TE has identified as EU ELV compliant have a maximum concentration of 0.1% by weight in homogenous materials for lead, hexavalent chromium, and mercury, and 0.01% for cadmium, or qualify for an exemption to these limits as defined in the Annexes of Directive 2000/53/EC (ELV). Regarding the REACH Regulation, the information TE provides on SVHC in articles for this part number is based on the latest European Chemicals Agency (ECHA) 'Guidance on requirements for substances in articles' posted at this URL: <https://echa.europa.eu/guidance-documents/guidance-on-reach>

## Compatible Parts

 <p>TE Part # CAT-L489-CH8172 LEAVYSEAL Housings</p>	 <p>TE Part # CAT-H3399-CH8172 Heavy Duty Sealed Connector Series Housings</p>	 <p>TE Part # 1-1579007-3 EXTRACTION TOOL</p>	 <p>TE Part # 1719043-1 SINGLE WIRE SEAL, GREEN</p>
 <p>TE Part # CAT-M8793-CH8172 MQS, CONNECTOR HOUSING</p>	 <p>TE Part # 1897210-1 MCP HYB 4P PLUG ASSY</p>	 <p>TE Part # CAT-AM705-CH8173 AMP MCP Unsealed Connector Housings</p>	 <p>TE Part # 2151151-2 OCEAN_2.0_APPLICATOR-S-130F270OV</p>



TE Part # 1394512-1  
EINZELLEITDICHTG,BL



TE Part # 1-2278915-4  
EPB4 30WAY ASSEMBLY PARTS



TE Part # 1-2344950-1  
95POS, HYBRID, REC HSG, ASSY, COD A



TE Part # 2-2344950-1  
95POS, HYBRID, REC HSG, ASSY, COD B



TE Part # 2305570-1  
Strip Terminal Cutter-Side Feed-No Crimp



TE Part # 2837453-2  
APPLICATOR TO MAKE LOOSE PIECE TERMINALS



TE Part # 7-2151151-2  
OCEAN\_2.0\_APPLICATOR-S-130F270OV



TE Part # 7-2151151-7  
OCEAN\_2.0\_SPARE\_PART\_KIT-130F270OV



TE Part # 7-2837453-7  
TOOLING KIT TO MAKE LOOSE PIECE TERMINAL



TE Part # 2394300-1  
EXTRACTION TOOL



TE Part # 1241417-3  
MCP6.3/4.8K

Also in the Series | AMP MCP Connector System



Automotive Connector Caps & Covers (22)

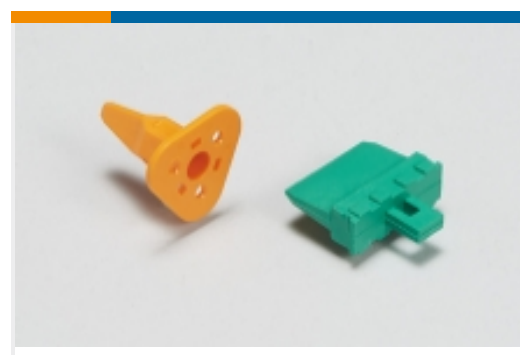

Automotive Connector Locks & Position Assurance(6)



Automotive Housings(332)



Automotive Terminals(130)



Connector Seals & Cavity Plugs(7)



Insertion & Extraction Tools(13)

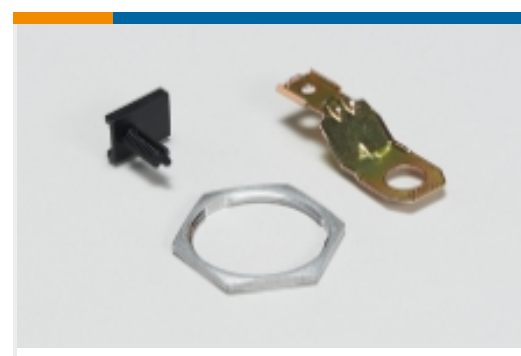

Other Automotive Connector Accessories(2)



PCB Headers & Receptacles(28)

Customers Also Bought



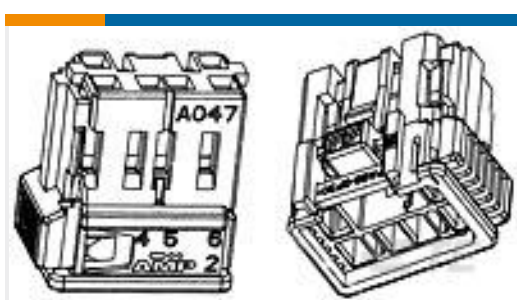

TE Part #282991-2  
CONN.NEW GEN.F. TRUCK



TE Part #965914-1  
TIMER, RECEPTACLE AND TAB



TE Part #2141861-1  
MCON 1.2 LL REC SRC SN



TE Part #NB11716001  
ATUM-8/2-0-35MM



TE Part #1394512-1  
EINZELLEITDICHTG,BL



TE Part #2151853-2  
OCEAN\_2.0\_Applicator-E-160F240OV



TE Part #2151927-2  
OCEAN\_2.0\_APPPLICATOR-S-165F244OV



TE Part #7-2151853-7  
OCEAN\_2.0\_SPARE\_PART\_KIT-160F240OV

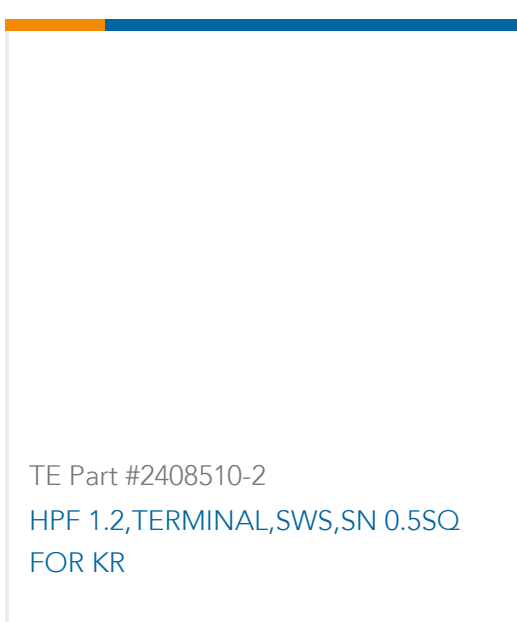

TE Part #2408510-2  
HPF 1.2,TERMINAL,SWS,SN 0.5SQ  
FOR KR

## Documents

### Product Drawings

[AMP MCP 6.3/4.8K, CONTACT, SWS](#)

English

[AMP MCP 6.3/4.8K, CONTACT, SWS](#)

English

### CAD Files

[3D PDF](#)

3D

Customer View Model

[ENG\\_CVM\\_CVM\\_1241416-3\\_A.2d\\_dxf.zip](#)

English

Customer View Model

[ENG\\_CVM\\_CVM\\_1241416-3\\_A.3d\\_igs.zip](#)

English

Customer View Model

[ENG\\_CVM\\_CVM\\_1241416-3\\_A.3d\\_stp.zip](#)

English

By downloading the CAD file I accept and agree to the [Terms and Conditions](#) of use.



---

**Datasheets & Catalog Pages**

[HDSCS Catalog](#)

English

[CONNECTOR SELECTOR](#)

English

---

**Product Specifications**

[Application Specification](#)

German

[Application Specification](#)

English