



TAOGLAS®



Datasheet

Part No:
SDDCP.5900.25.10.A.08

Description:
Stacked SDARS & C-V2X Patch Antenna for OEM Automotive Applications

Features:
High Efficiency/ High Peak Gain
SDARS & C-V2X Stacked patch antenna
Dual Feed Patch Assembly
Through-Hole Mounting Pin Type
Dimensions: 25*25*10mm
RoHS & Reach Compliant

1. Introduction	3
2. Specifications	4
3. Antenna Characteristics	5
4. Radiation Patterns	9
5. Mechanical Drawing	11
6. Recommended Pin Feed Pad Layout	12
7. Antenna Integration Guide	13
8. Mechanical Drawing Evaluation Board	18
9. Packaging	19
Changelog	20

Taoglas makes no warranties based on the accuracy or completeness of the contents of this document and reserves the right to make changes to specifications and product descriptions at any time without notice. Taoglas reserves all rights to this document and the information contained herein. Reproduction, use or disclosure to third parties without express permission is strictly prohibited.



1. Introduction



The SDDCP.5900.25.10.A.08 is a passive embedded ceramic stacked patch antenna with both SDARS and C-V2X capabilities. Using a stacked dual patch assembly for both bands results in the most economical and space-efficient solution for demanding applications requiring both SDARS and C-V2X. The patch assembly is easy to integrate with an overall footprint size of just 25x25mm and sits at 10.15mm in height.

The SDARS patch at 25mm*25mm is designed for use with Satellite Digital Audio Radio Services (SDARS). It features left-hand circular polarization, low in-band axial ratio, and excellent gain characteristics in the 2320 to 2345 MHz band, making it compatible with the most popular satellite radio services available in many new vehicles. It is extremely efficient with up to 80% efficiency at 2332.5MHz.

The C-V2X patch at 12mm*12mm is used as the communications medium of choice for active safety V2V/C-V2X (Vehicle-to-Vehicle and Vehicle-to-Other) or DSRC (Dedicated Short Range Communications) systems. Primarily allocated for vehicle safety applications, C-V2X supports high-speed, low-latency, DSRC, V2V/C-V2X wireless communications. The C-V2X patch also has left hand circular polarization and nearly 70% efficiency at 5900MHz.

A typical use case would include utilizing the stacked patch in shark fin style external automotive roof mounted antennas.

This antenna has been tuned and tested on a 70 x 70 mm ground plane. Custom tuning services can be provided for further optimization to customer-specific device environments. Note that certification of your device and/or the antenna may be required by certain Satellite Radio providers. Further engineering may be needed to meet their requirements. Contact your regional Taoglas sales office for support.

For further information, please contact your regional Taoglas customer support team.

2. Specifications

Wi-Fi Electrical						
Band	Frequency (MHz)	Efficiency (%)	Return Loss (dB)	Peak Gain (dBi)	Impedance	Polarization
SDARS	2320~2345	80.3	-10	5.4	50 Ω	LHCP
C-V2X	5850~5925	68.5	-10	3.5		R.H.C.P

Mechanical	
Dimensions	25 x 25 x 10.15mm SDARS: 25 x 25 x 6 mm C-V2X: 12 x 12 x 4 mm
Material	Ceramic
Pin Diameter	0.8mm
Pin Length	2.0mm
Weight	13.9g
Environmental	
Operation Temperature	-40°C to +85°C
Humidity	Non-condensing 65°C 95% RH
Moisture Sensitivity Level (MSL)	3 (168 Hours)

3. Antenna Characteristics

3.1 Return Loss

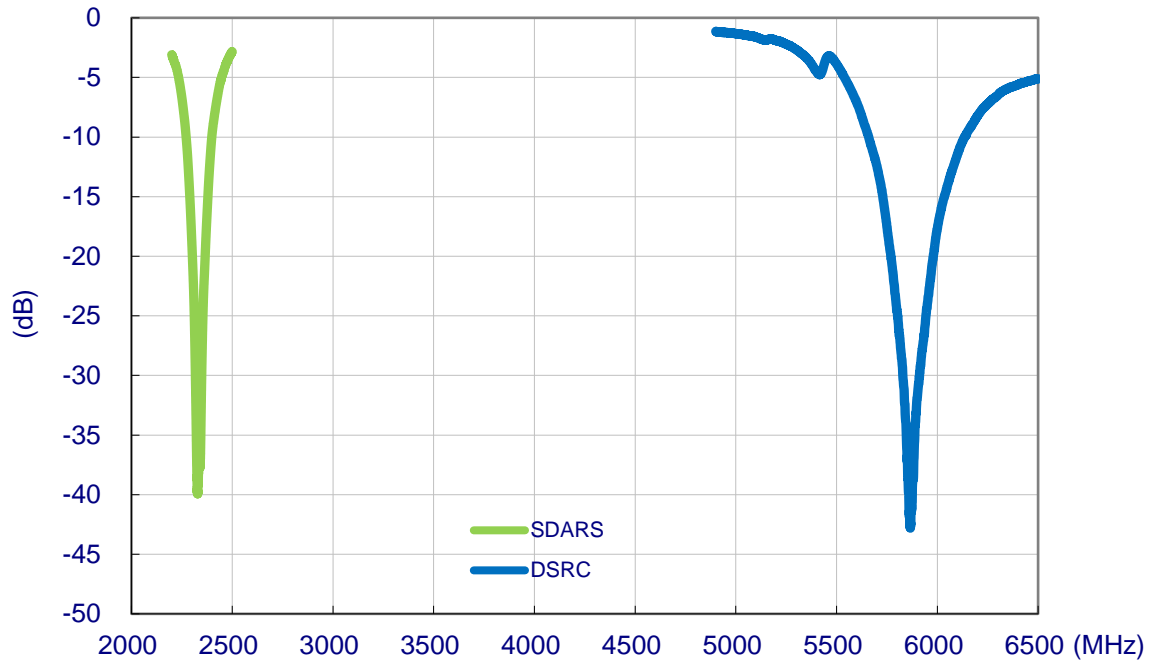

3.2 Efficiency

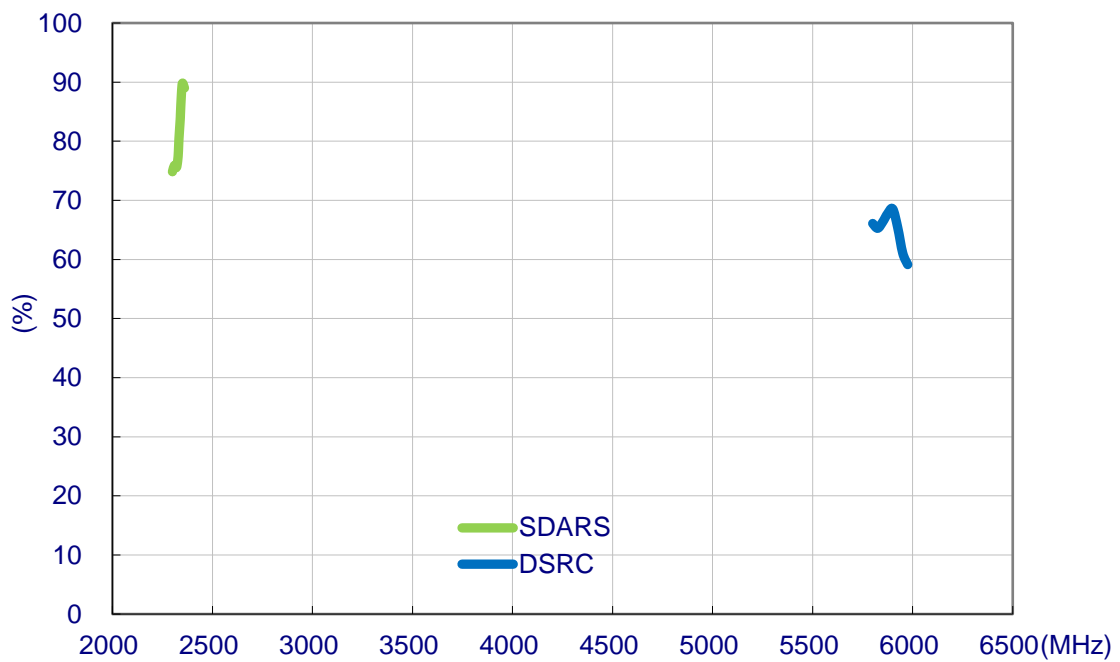

3.3 Average Gain

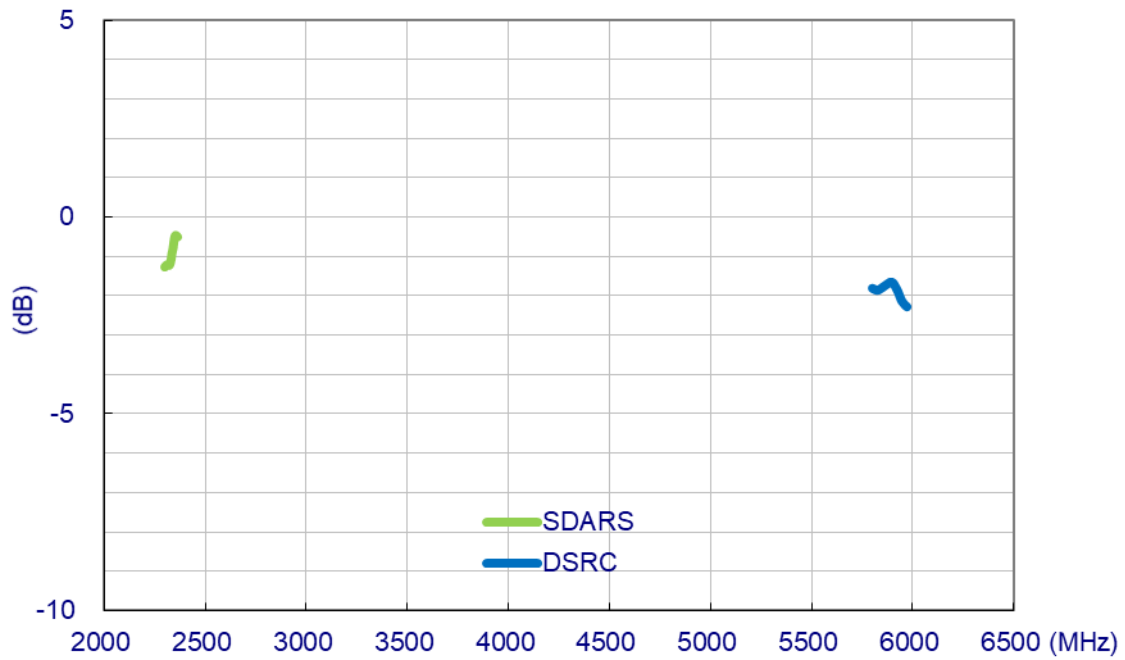

3.4 Peak Gain

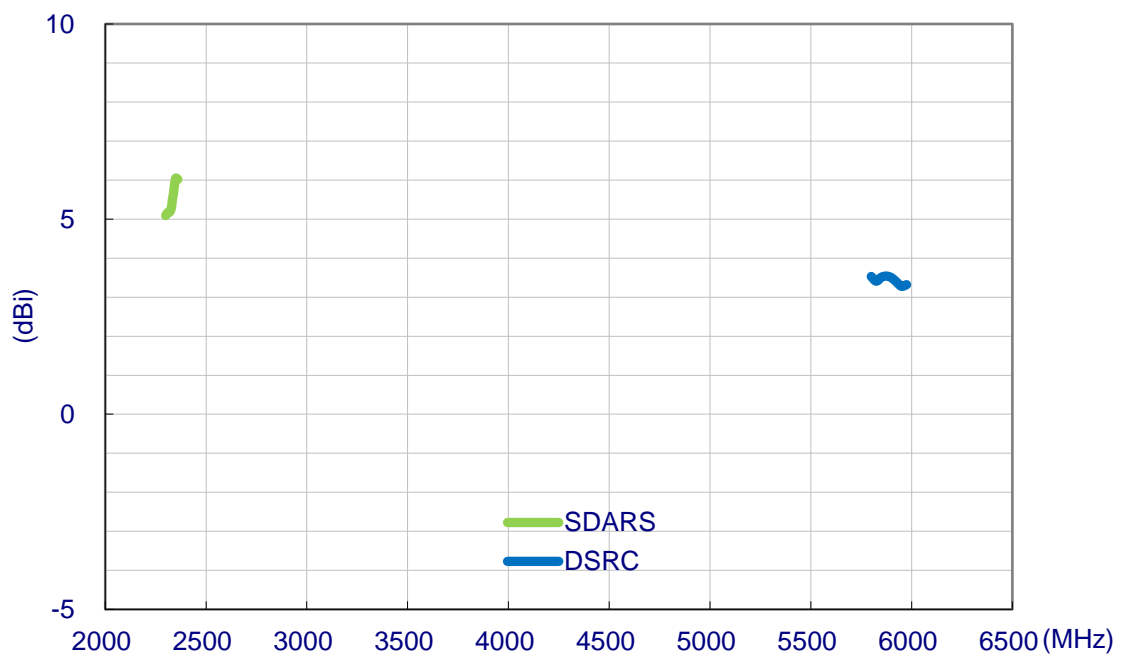

3.5 Axial Ratio (Zenith is at 0°)

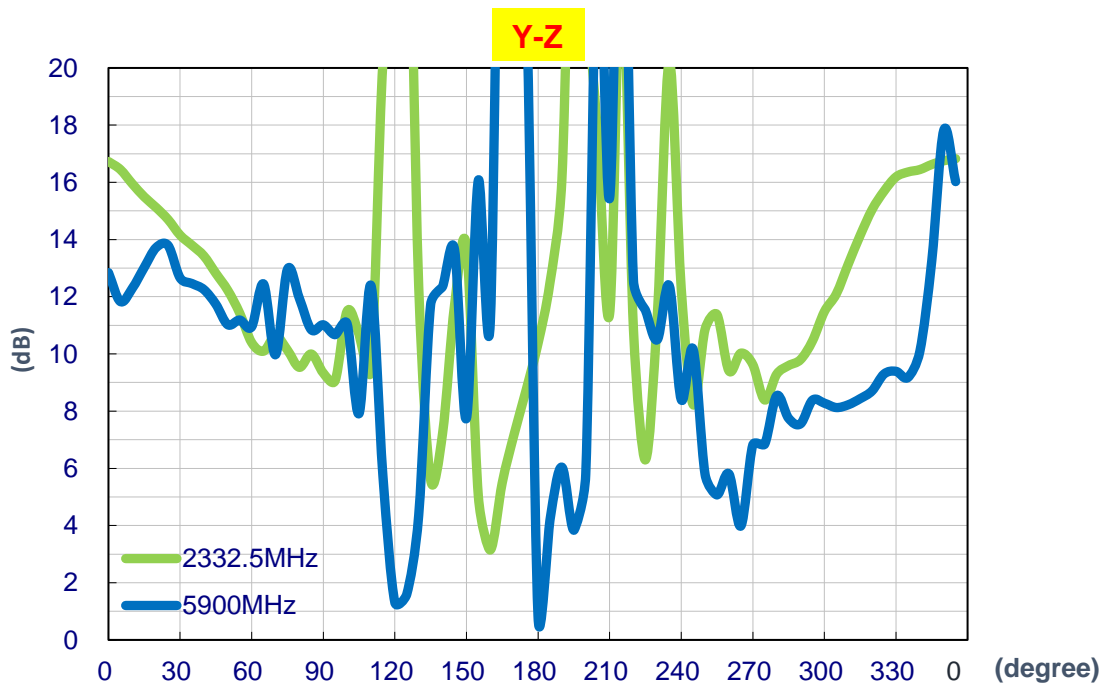
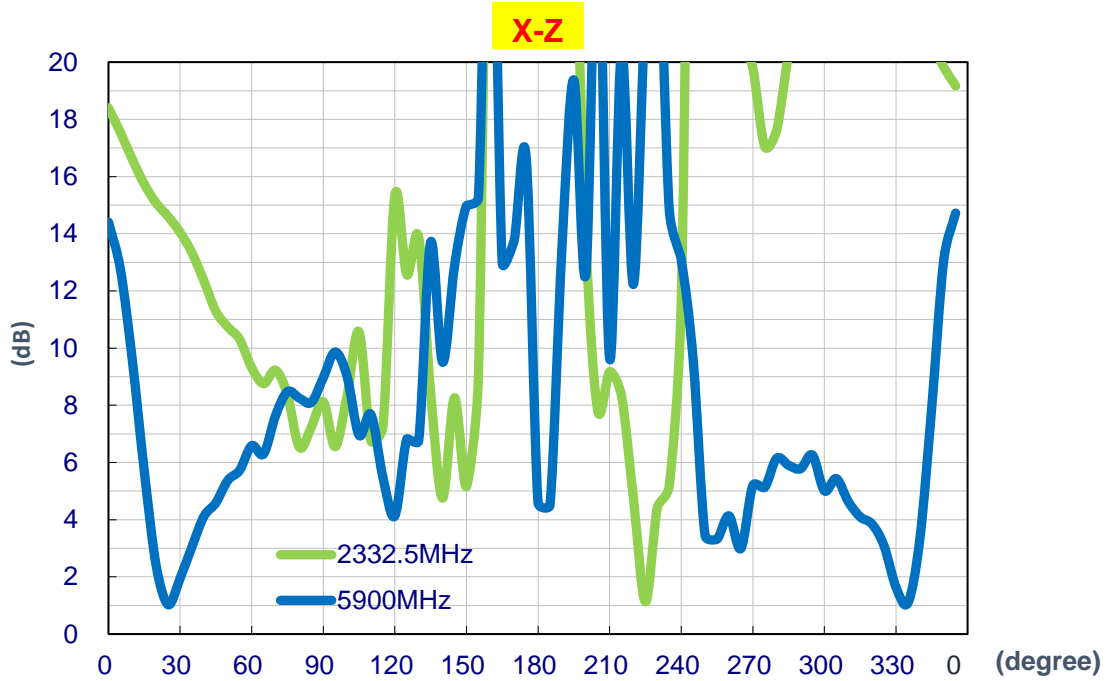

3.6 Isolation

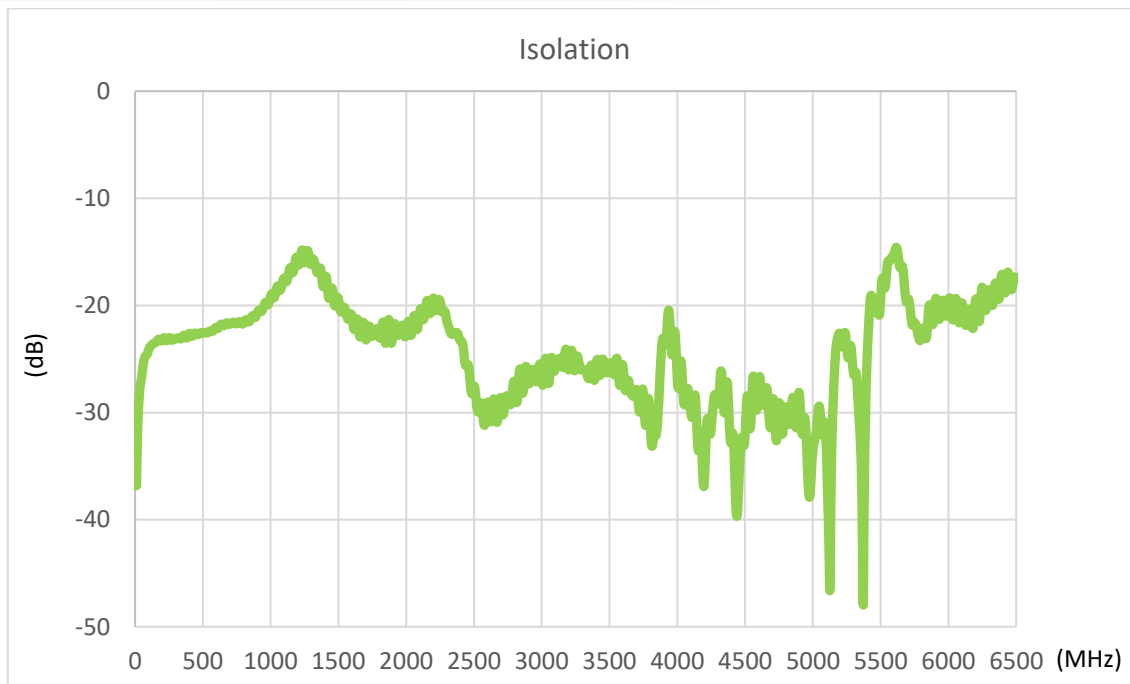

3.7 XM Gain Requirements (Satellite) – Ground Plane

AUT Location	Elevation Angle(degrees)	Linear Average Gain(dBic)
Passive Ground Plane	$20 \leq \phi \leq 25$	-1.1
	$25 \leq \phi \leq 30$	-0.5
	$30 \leq \phi \leq 50$	1.1
	$50 \leq \phi \leq 70$	3.2
	$70 \leq \phi \leq 90$	4.2

3.8 XM Gain Requirements (Terrestrial) – Ground Plane

AUT Location	Elevation Angle(degrees)	Antenna Mean Passive VP Gain Over Solid Angle (dBi)	Antenna P/P Gain variation (dB)
Passive Ground Plane	$0^\circ \leq \phi \leq 10^\circ$	-7.0	-
	$\Phi = 5^\circ$	-	6.1

4. 2D Radiation Patterns

4.1 Test Setup

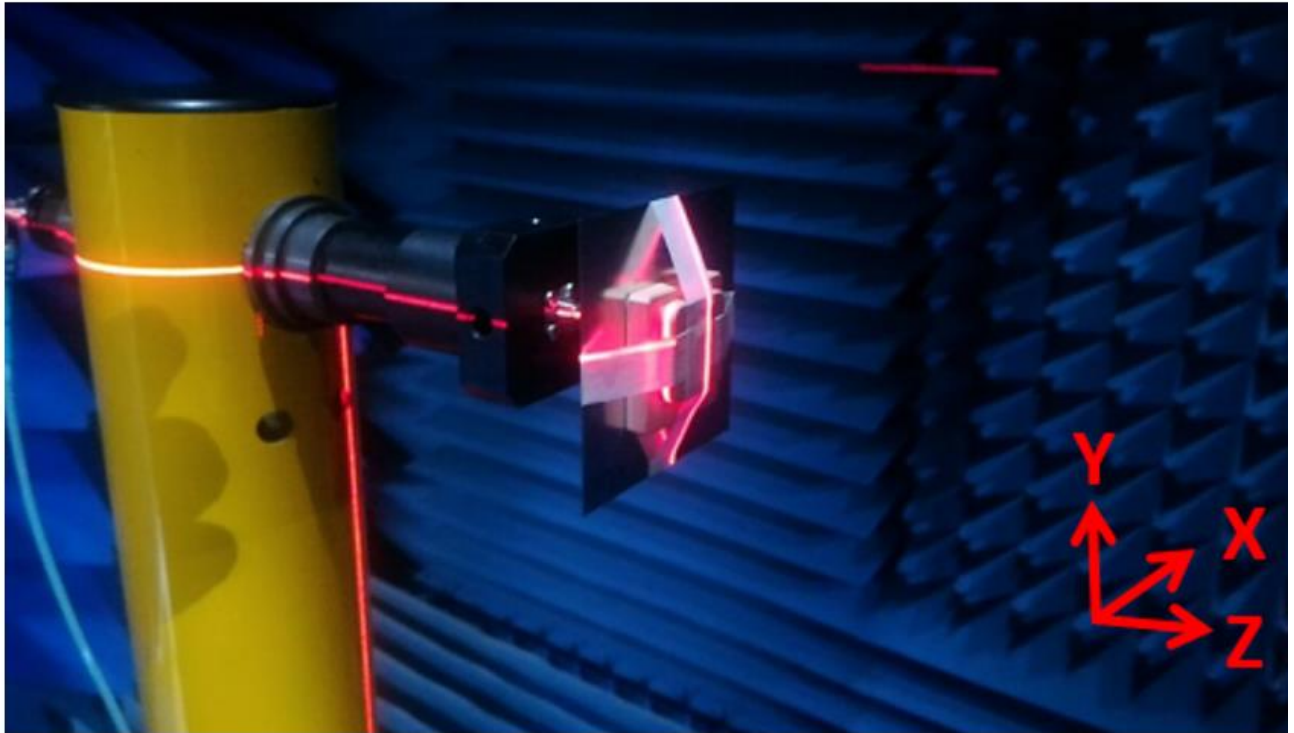

4.2 2D/3D Radiation Patterns

2400-2500MHz

XY Plane

XZ Plane

YZ Plane

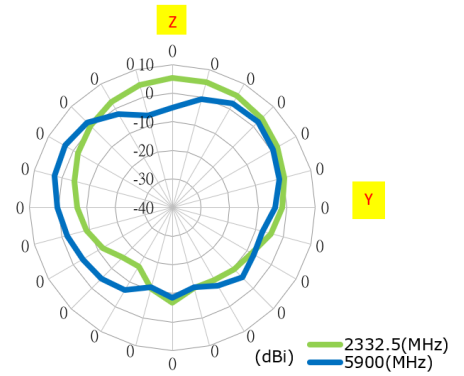
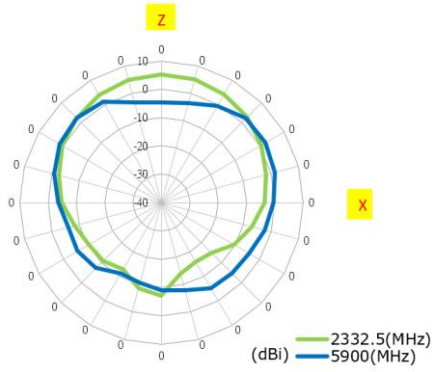
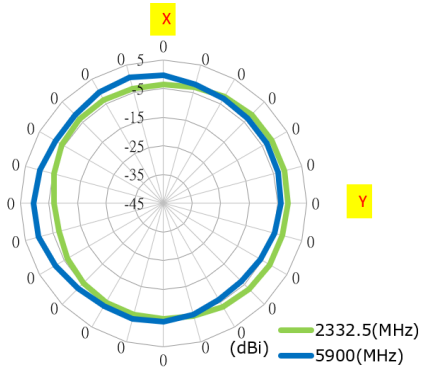

2332.5 MHz

5900 MHz

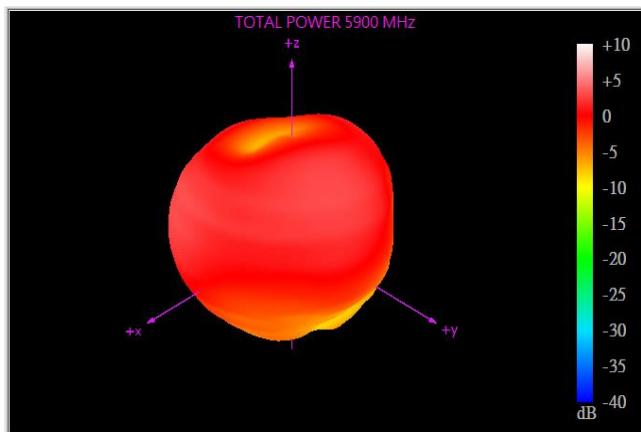
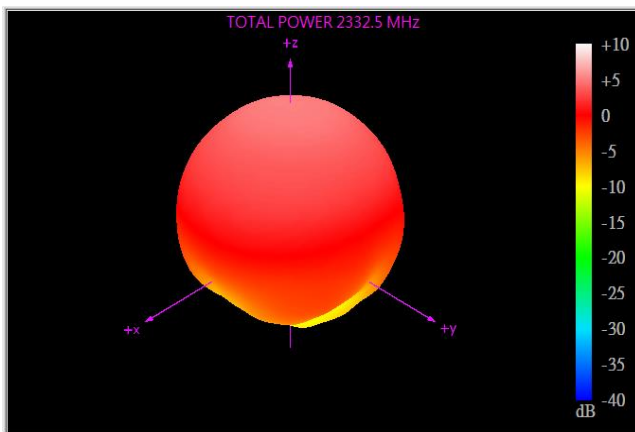

5. Mechanical Drawing (Units: mm)

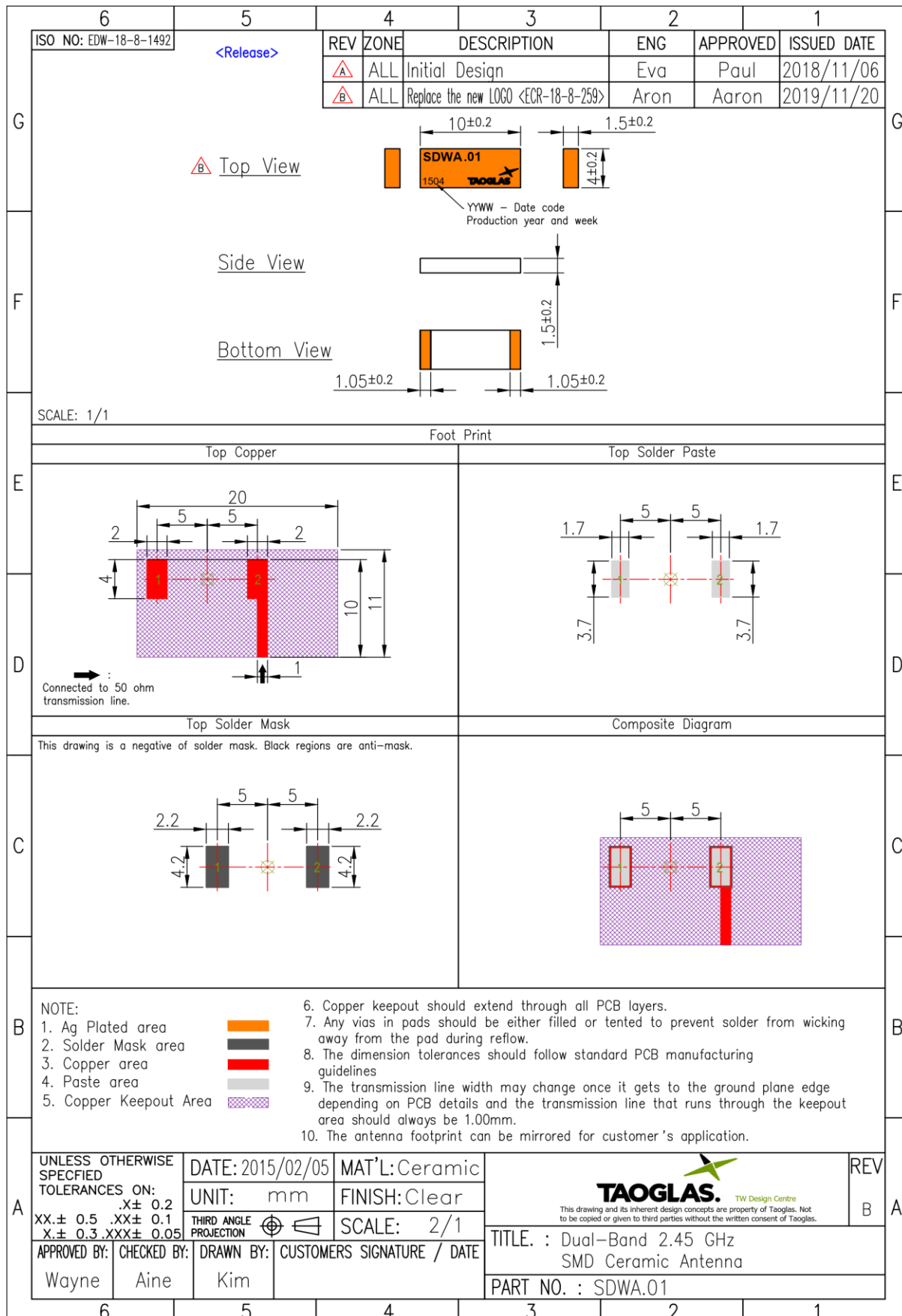

6. Recommended Pin Feed Pad Layout

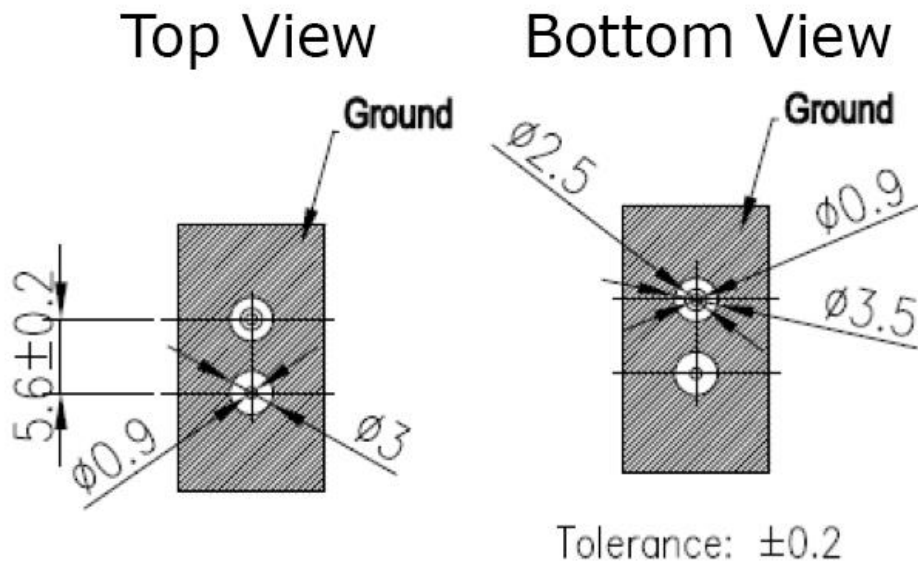

7. Antenna Integration Guide



7.1 Schematic Symbol and Pin Definition

The circuit symbol for the antenna is shown below. The antenna has 2 pins as indicated below. The SDARS pin represents the lower GNSS frequency bands at 2332.5MHz and the DSRC pin represents the higher GNSS frequency bands at 5900MHz.

Pin	Description
1	SDARS
2	DSRC

SDDCP.5900.25.10.A.08
ANT1

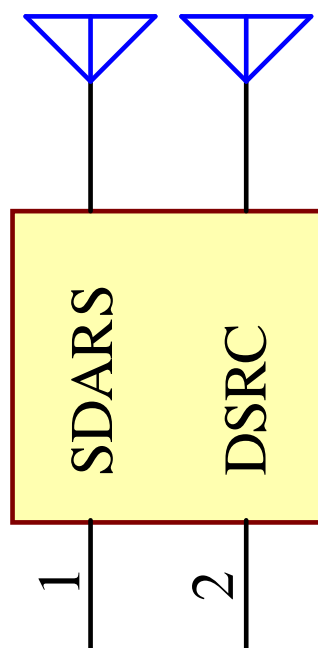

7.2 Antenna Integration

The antenna should be placed at the center of the ground plane with a length and width of 70mm. Maintaining a square symmetric ground plane shape and symmetric environment around the antenna is critical to maintaining the excellent axial ratio and phase center performance shown in this datasheet.

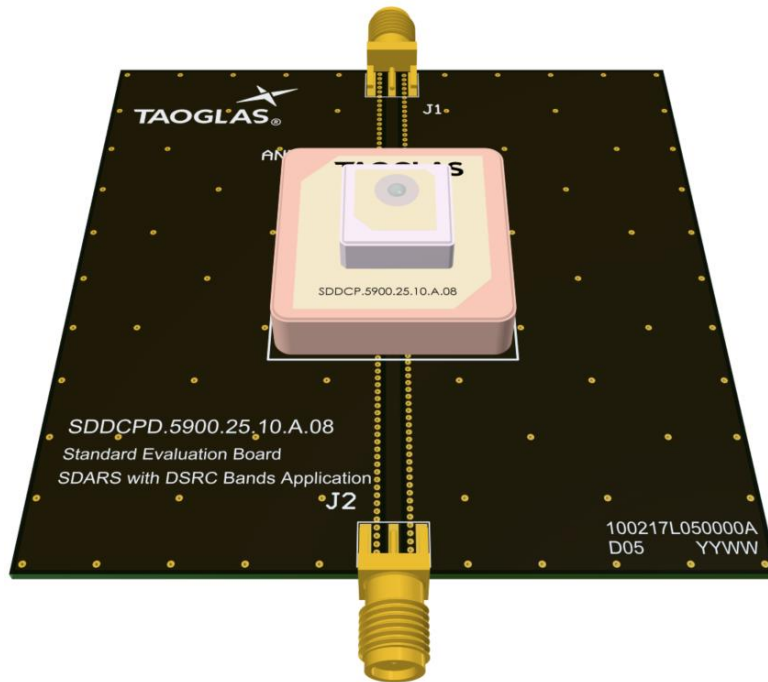

Top Side w/ Solder Mask

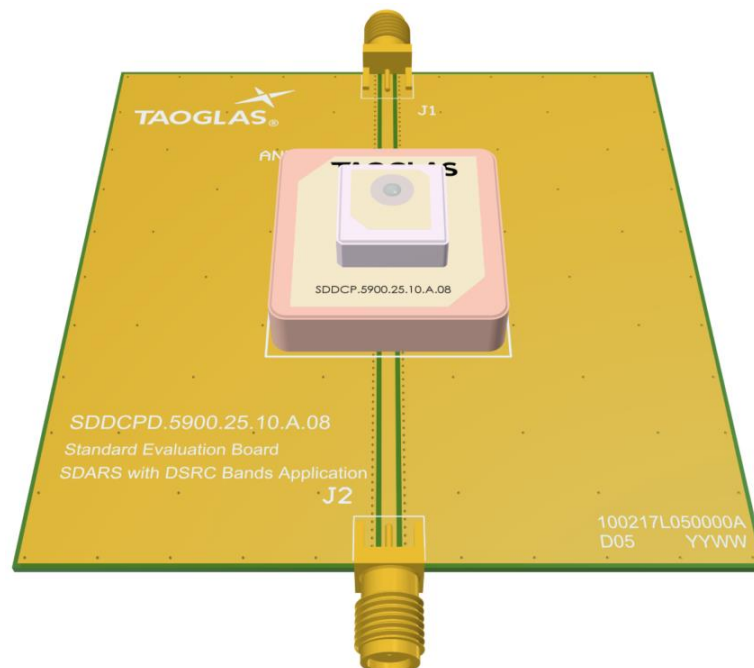

Top Side w/o Solder Mask

7.3 PCB Layout

The footprint and clearance on the PCB must meet the layout drawing in (Footprint Drawing).

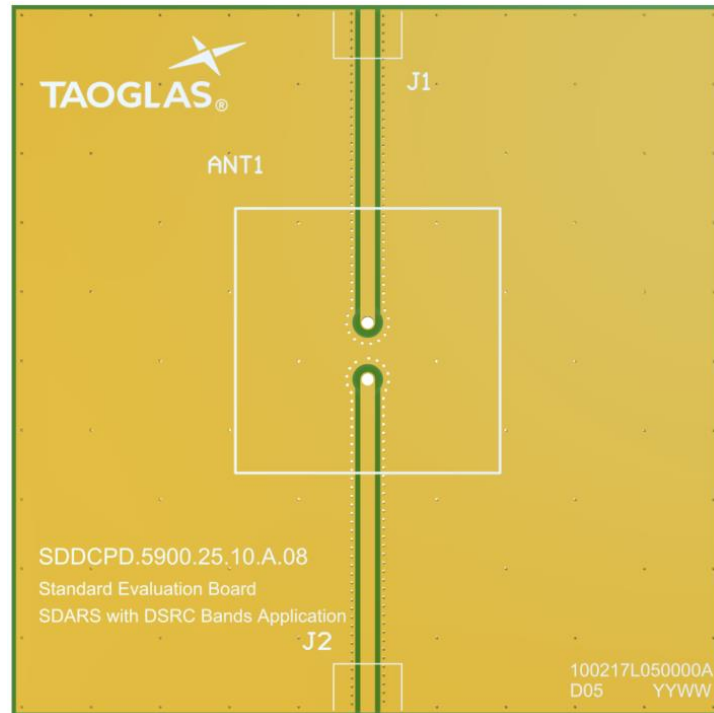

Topside

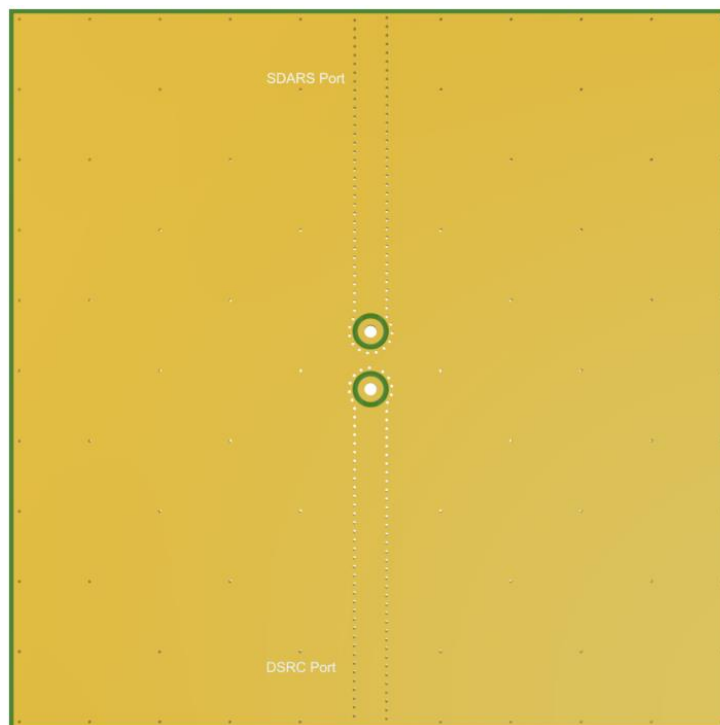

Bottom Side

7.5 Evaluation Board

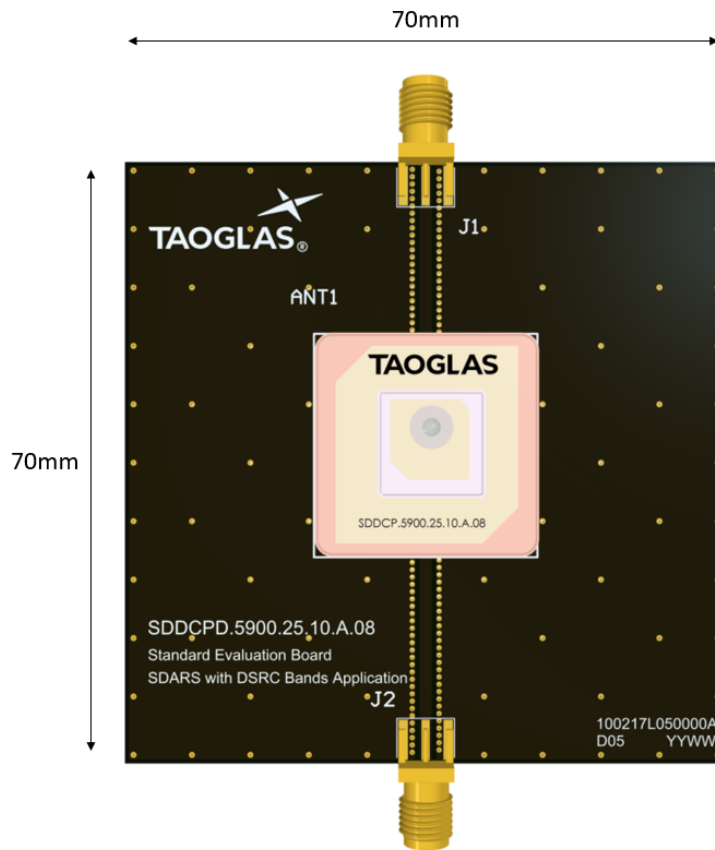

Topside

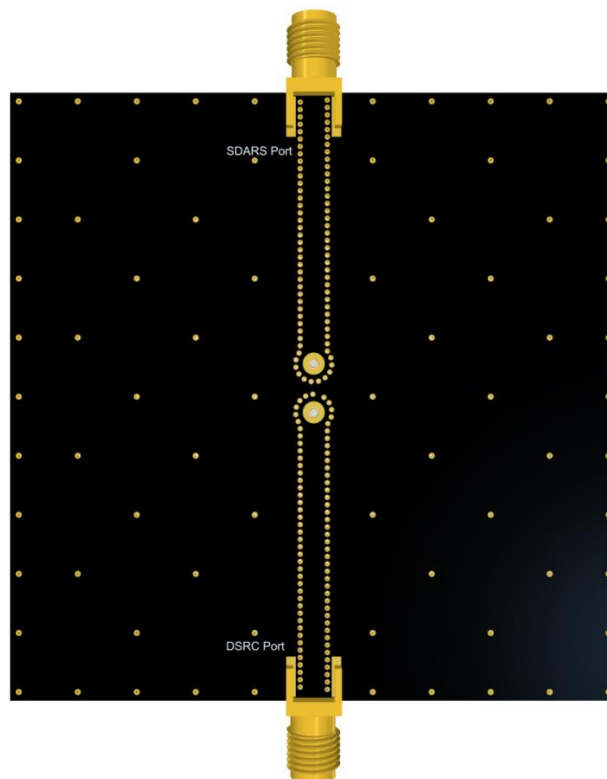

Bottom Side

8. Mechanical Drawing – Evaluation Board

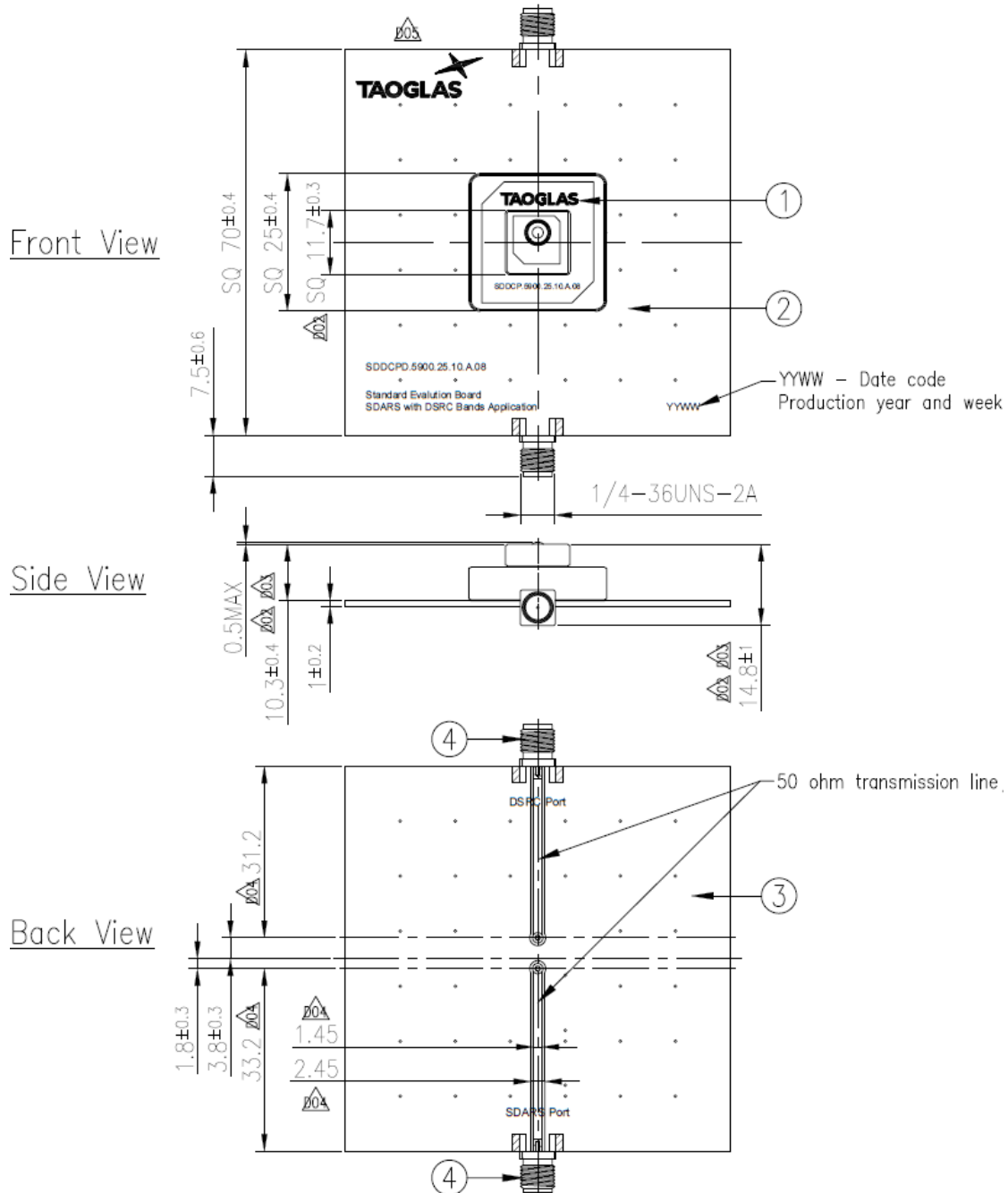

NOTES:

- 1. Soldermask Area
- 2. Soldered Area

	Name	P/N	Material	Finish	QTY
1	Patch-1 (12x12x4mm)	001518A010000A	Ceramic	Clear	1
2	Patch-2 (25x25x6mm)	001518A020000A	Ceramic	Clear	1
3	PCB	100217L050000A	Composite 1t	Black	1
4	SMA(F)ST	200417L00006FA	Brass	Au Plated	2

9. Packaging

30 pcs SDDCP.5900.25.10.A.08 per Tray
 Tray Dimensions - 300*370*30mm
 Weight - 596g

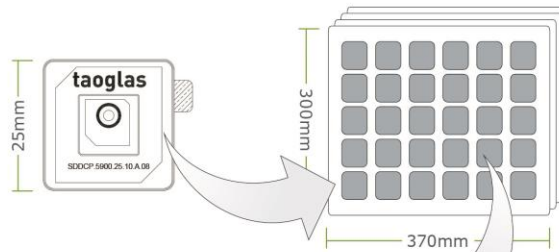

120 pcs SDDCP.5900.25.10.A.08 per Vacuum Bag
 Vacuum Bag Dimensions - 300*370*50mm
 Weight - 2.4kg

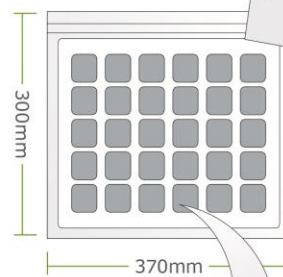

360 pcs GPSDSF.35.7.A.08 per Carton
 Carton Dimensions - 390*320*270mm
 Weight - 10.05kg

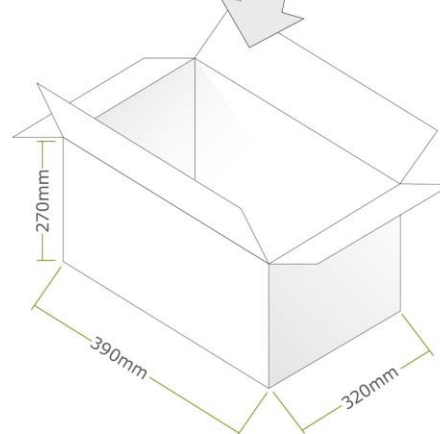

Pallet Dimensions:
 1200mm*1000mm*1280mm
 36 Cartons per Pallet
 9 Cartons per Layer, 4 Layers

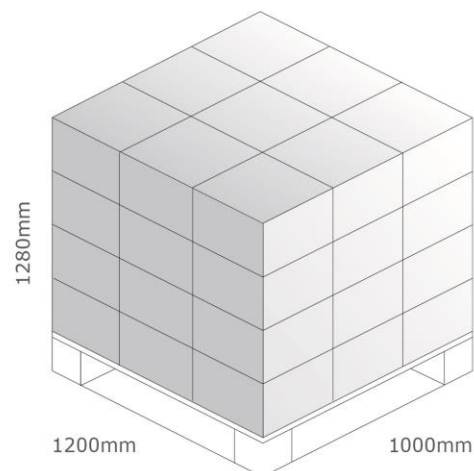

Changelog for the datasheet

SPE-18-8-066– SDDCP.5900.25.10.A.08

Revision: D (Current Version)

Date:	2023-05-05
Changes:	Antenna Integration Guide Added
Changes Made by:	Cesar Sousa

Previous Revisions

Revision: C

Date:	2019-10-25
Changes:	Updated Electrical Specifications
Changes Made by:	Jack Conroy

Revision: B

Date:	2018-09-11
Changes:	Updated drawing and patch dimensions on mechanical
Changes Made by:	Jack Conroy

Revision: A (Original First Release)

Date:	2018-02-07
Notes:	
Author:	Technical Writer



www.taoglas.com

