

4V Drive Pch MOSFET

AEC-Q101 Qualified

RSL020P03FRA

●Structure

Silicon P-channel MOSFET

●Features

- 1) Low On-resistance.
- 2) High speed switching.

●Applications

Switching

●Packaging specifications

Type	Package	Taping
	Code	TR
	Quantity (pcs)	3000
RSL020P03FRA		○

●Dimensions (Unit : mm)

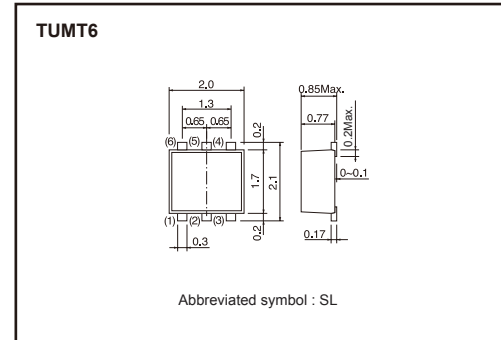

●Inner circuit

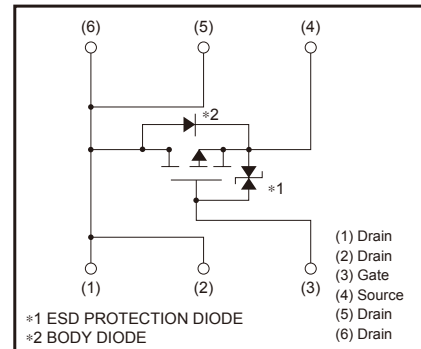

●Absolute maximum ratings (Ta=25°C)

Parameter	Symbol	Limits	Unit	
Drain-source voltage	V_{DS}	-30	V	
Gate-source voltage	V_{GS}	±20	V	
Drain current	Continuous	I_D	±2	A
	Pulsed	I_{DP} *1	±8	A
Source current (Body diode)	Continuous	I_S	-0.8	A
	Pulsed	I_{SP} *1	-8	A
Total power dissipation	P_D *2	1	W	
Channel temperature	T_{ch}	150	°C	
Range of storage temperature	T_{stg}	-55 to +150	°C	

*1 $P_w \leq 10 \mu s$, Duty cycle $\leq 1\%$

*2 Mounted on a ceramic board

●Thermal resistance

Parameter	Symbol	Limits	Unit
Channel to ambient	$R_{th(ch-a)}$ *	125	°C/W

* Mounted on a ceramic board

Transistors

●Electrical characteristics (Ta=25°C)

Parameter	Symbol	Min.	Typ.	Max.	Unit	Conditions
Gate-source leakage	I_{GSS}	–	–	± 10	μA	$V_{GS} = \pm 20V, V_{DS} = 0V$
Drain-source breakdown voltage	$V_{(BR)DSS}$	–30	–	–	V	$I_D = -1mA, V_{GS} = 0V$
Zero gate voltage drain current	I_{DSS}	–	–	–1	μA	$V_{DS} = -30V, V_{GS} = 0V$
Gate threshold voltage	$V_{GS(th)}$	–1.0	–	–2.5	V	$V_{DS} = -10V, I_D = -1mA$
Static drain-source on-state resistance	$R_{DS(on)}$ *	–	80	120	m Ω	$I_D = -2A, V_{GS} = -10V$
		–	125	190	m Ω	$I_D = -1A, V_{GS} = -4.5V$
		–	140	210	m Ω	$I_D = -1A, V_{GS} = -4.0V$
Forward transfer admittance	$ Y_{fs} $ *	1.4	–	–	S	$V_{DS} = -10V, I_D = -1A$
Input capacitance	C_{iss}	–	350	–	pF	$V_{DS} = -10V$
Output capacitance	C_{oss}	–	80	–	pF	$V_{GS} = 0V$
Reverse transfer capacitance	C_{rss}	–	50	–	pF	$f = 1MHz$
Turn-on delay time	$t_{d(on)}$ *	–	11	–	ns	$V_{DD} = -15V$
Rise time	t_r *	–	11	–	ns	$I_D = -1A$
Turn-off delay time	$t_{d(off)}$ *	–	35	–	ns	$V_{GS} = -10V$
Fall time	t_f *	–	11	–	ns	$R_L = 15\Omega$
Total gate charge	Q_g	–	3.9	–	nC	$V_{DD} = -15V, V_{GS} = -5V$
Gate-source charge	Q_{gs}	–	1.3	–	nC	$I_D = -2A$
Gate-drain charge	Q_{gd}	–	1.1	–	nC	$R_L = 7.5\Omega, R_G = 10\Omega$

*Pulsed

●Body diode characteristics (Source-drain) (Ta=25°C)

Parameter	Symbol	Min.	Typ.	Max.	Unit	Conditions
Forward voltage	V_{SD}	–	–	–1.2	V	$I_S = -0.8A, V_{GS} = 0V$

Transistors

●Electrical characteristics curves

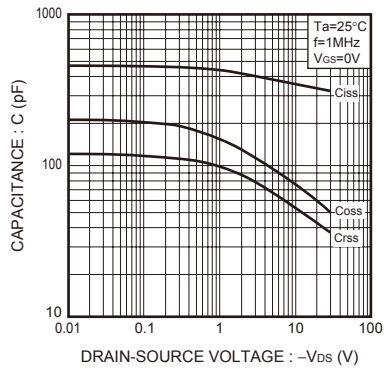

Fig.1 Typical Capacitance vs. Drain-Source Voltage

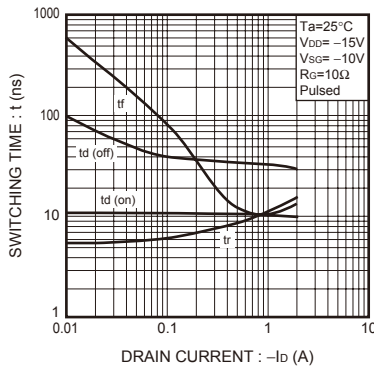

Fig.2 Switching Characteristics

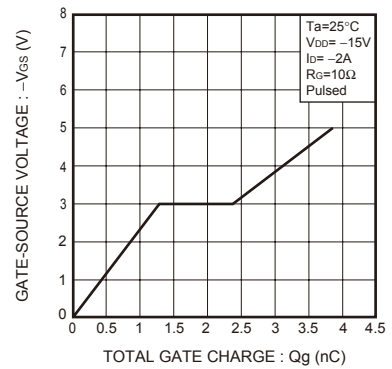

Fig.3 Dynamic Input Characteristics

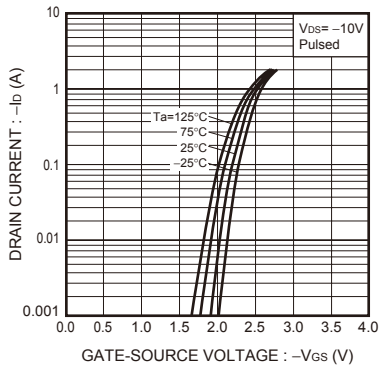

Fig.4 Typical Transfer Characteristics

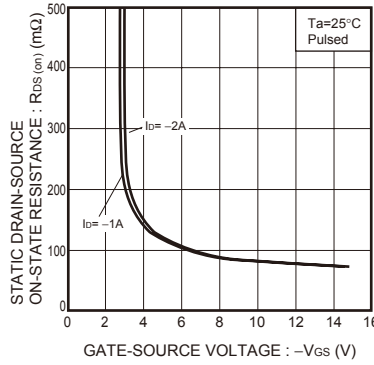

Fig.5 Static Drain-Source On-State Resistance vs. Gate-Source Voltage

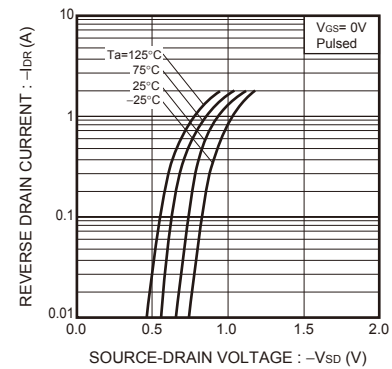

Fig.6 Reverse Drain Current vs. Source-Drain Voltage

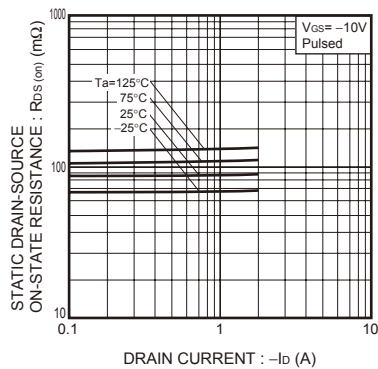

Fig.7 Static Drain-Source On-State Resistance vs. Drain current (I)

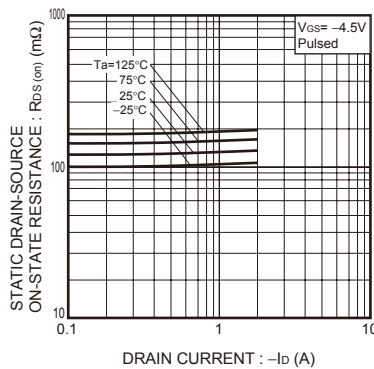

Fig.8 Static Drain-Source On-State Resistance vs. Drain current (II)

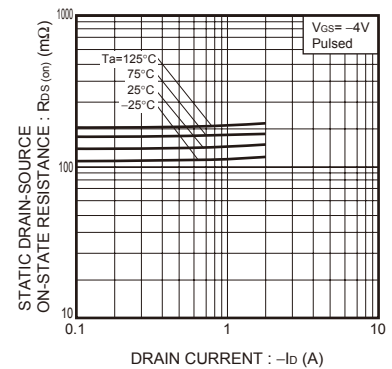

Fig.9 Static Drain-Source On-State Resistance vs. Drain current (III)

Transistors

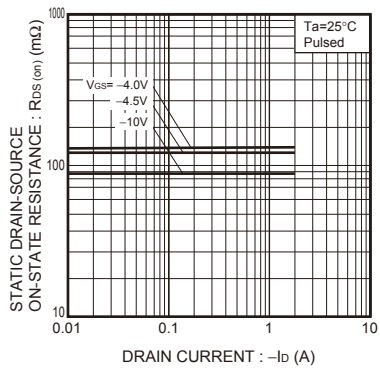

Fig.10 Static Drain-Source On-State Resistance vs. Drain current (I_D)