

Features

- 3W power in compact SMD package
- Operating temperature from -40°C to +81°C with no derating
- 2kVDC or 3kVDC/1minute isolation voltage
- IEC/EN/UL62368 3rd Edition certified
- Fully protected- OLP, OCP & SCP

Regulated Converters

RSH3

3 Watt
SMD DIP14
Single and Dual



UL62368-1 3rd Edition certified
CAN/CSA-C22.2 No. 62368-1 certified
IEC/EN62368-1 2nd + 3rd Ed. certified
EN55032 compliant
EN55035 compliant
EN55024 compliant
CB Report

Description

High power density 3W SMD isolated DC/DC single and dual output converters. The RSH3 is available with three different input ranges and offers single or dual regulated output. There is no minimum load requirement. Standard isolation is 2kVDC/1min and a /H3 version with 3kVDC/1min is available. The operating temperature is from -40°C up to +81°C without derating. The DIP14 SMD pin-out is industry standard, and the converters come equipped with ON/OFF control and, short circuit protection, and over current protection, making them ideal for highly sophisticated industrial designs. The converters are fully certified to IEC/EN/UL62368 (3rd Edition) and are 10/10 RoHS conform.

Selection Guide

Part Number	Input Voltage Range [VDC]	Output Voltage [VDC]	Output Current [mA]	Efficiency typ. ⁽¹⁾ [%]	max. Capacitive Load ⁽²⁾ [µF]
RSH3-1205S ^(3,4)	9-18	5	600	79	1680
RSH3-1212S ^(3,4)	9-18	12	250	81	820
RSH3-1215S ^(3,4)	9-18	15	200	82	680
RSH3-1224S ^(3,4)	9-18	24	125	82	470
RSH3-1212D ^(3,4)	9-18	±12	±125	82	±470
RSH3-1215D ^(3,4)	9-18	±15	±100	82	±330
RSH3-2405S ^(3,4)	18-36	5	600	80	1680
RSH3-2412S ^(3,4)	18-36	12	250	81	820
RSH3-2415S ^(3,4)	18-36	15	200	82	680
RSH3-2424S ^(3,4)	18-36	24	125	82	470
RSH3-2412D ^(3,4)	18-36	±12	±125	83	±470
RSH3-2415D ^(3,4)	18-36	±15	±100	83	±330

Notes:

Note1: Efficiency is tested at nominal input and full load at +25°C ambient

Note2: Max Cap Load is tested at nominal input and full resistive load

Model Numbering



Notes:

Note3: add suffix "/H2" for 2kVDC isolation
add suffix "/H3" for 3kVDC isolation, for more information refer to **"Isolation Voltage ⁽⁷⁾"**

Note4: without suffix = standard tube packaging
add suffix „-R“ for tape and reel packaging for more details, refer to **"PACKAGING INFORMATION"**

Ordering Examples:

RSH3-1205S/H2	9-18Vin	5Vout	single output	2kVDC/1sec isolation	tube packaging (25pcs)
RSH3-2405S/H2-R	18-36Vin	5Vout	single output	2kVDC/1sec isolation	Tape and Reel (150pcs)
RSH3-1212D/H3	9-18Vin	±12Vout	dual output	3kVDC/1sec isolation	tube packaging (25pcs)

Specifications (measured @ Ta= 25°C, nom. Vin, full load and after warm-up unless otherwise stated)

BASIC CHARACTERISTICS

Parameter	Condition	Min.	Typ.	Max.
Internal Input Filter				Pi type
Input Voltage Range	nom. Vin= 12VDC 24VDC	9VDC 18VDC		18VDC 36VDC
Input Surge Voltage	nom. Vin= 12VDC 24VDC			25VDC 50VDC
Minimum Load		0%		
ON/OFF CTRL	DC-DC ON DC-DC OFF			Open or High impedance 4.5VDC Supply to 68Ω or IN1418
Internal Operating Frequency	100% load		130kHz	
Output Ripple and Noise ⁽⁶⁾	20MHz BW		30mVp-p	75mVp-p

Notes:

Note5: Measurements are made with a 0.1μF MLCC across output. (low ESR)

Efficiency vs. Load

RSH3-1205S

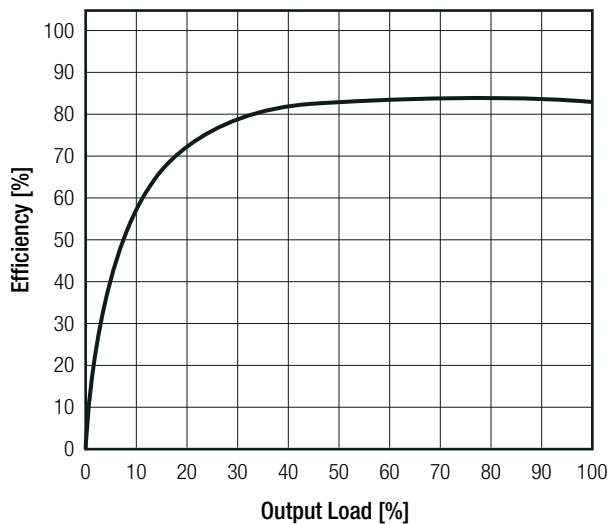

RSH3-2405S

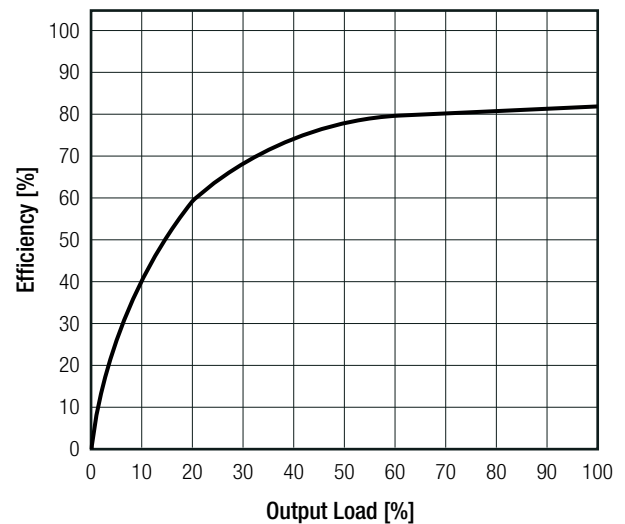

RSH3-2405D

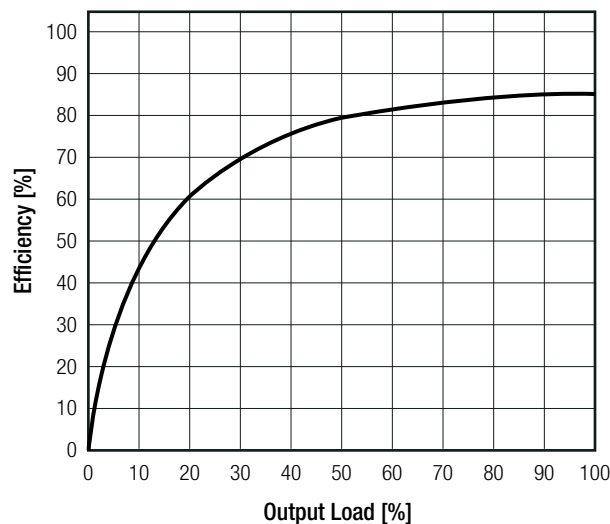

Specifications (measured @ Ta= 25°C, nom. Vin, full load and after warm-up unless otherwise stated)

CTRL Circuit

RSH3-24xxS_D

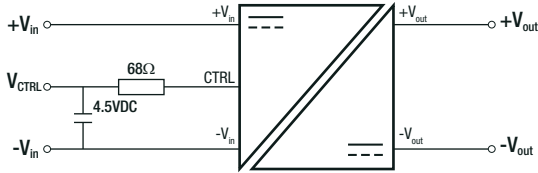

RSH3-12XXS_D

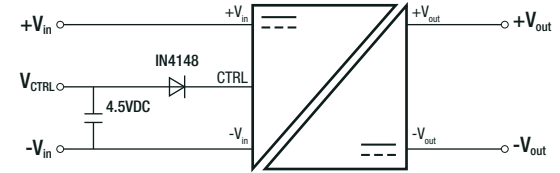

REGULATIONS

Parameter	Condition	Value
Output Accuracy		±1.0% max.
Line Regulation	low line to high line, full load	±0.2% max.
Load Regulation ⁽⁶⁾	0% to 100% load	0.5% max.
Cross Regulation	Asymmetrical load 25%/100% dual output only	±5.0% max.

Notes:

Note6: Operation below 20% load will not harm the converter, but specifications may not be met

PROTECTIONS

Parameter	Type	Value
Short Circuit Protection (SCP)	below 100mΩ	continuous, auto recovery
Over Load Protection (OLP)	100% load	160% typ.
Isolation Voltage ⁽⁷⁾	I/P to O/P	with suffix "H2" tested for 1 minute 2kVDC 0.5kVAC
		with suffix "H3" tested for 1 minute 3kVDC 1kVAC
Isolation Resistance		1GΩ min.
Isolation Capacitance		50pF typ.

Notes:

Note7: For repeat Hi-Pot testing, reduce the time and/or the test voltage

Note8: Refer to local safety regulations if input over-current protection is also required. Recommended fuse: slow blow type

ENVIRONMENTAL

Parameter	Condition	Value
Operating Temperature Range	@ natural convection 0.1m/s refer to "Derating Graph"	-40°C to +100°C
Maximum Case Temperature		105°C
Temperature Coefficient		±0.05%/K
Operating Altitude		5000m
Operating Humidity	non-condensing	5% to 95% RH max.
Pollution Degree		PD2
Vibration	according to MIL-STD-202G	10-55Hz, 2G, 30min along x y and z axes
MTBF	according to MIL-HDBK-217F, G.B.	+25°C 2872 x 10 ³ hours
		+81°C 836 x 10 ³ hours

continued on next page

Specifications (measured @ Ta= 25°C, nom. Vin, full load and after warm-up unless otherwise stated)

Derating Graph

(@ Chamber and natural convection 0.1 m/s)

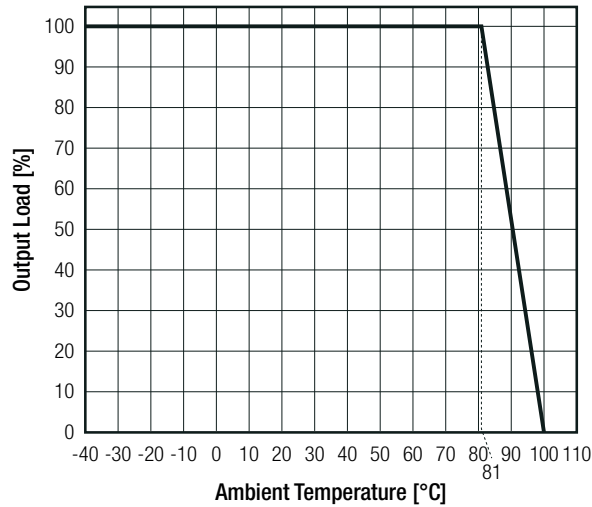

SAFETY AND CERTIFICATIONS

Certificate Type (Safety)	File Number	Standard
Audio/video, information and communication technology equipment. Safety requirements	E224736-A6025-UL	UL62368-1:2019 3rd Edition CAN/CSA-C22.2 No. 62368-1:2019
Audio/Video, information and communication technology equipment - Part1: Safety requirements (CB)	2002009-1-CB	IEC62368-1:2014 2nd Edition
Audio/Video, information and communication technology equipment - Part1: Safety requirements		EN62368-1:2014 + A11:2017
Audio/Video, information and communication technology equipment - Part1: Safety requirements (CB)	2002009-3-CB	IEC62368-1:2018 3rd Edition
Audio/Video, information and communication technology equipment - Part1: Safety requirements		EN IEC 62368-1:2020 + A11:2020
RoHS2		RoHS-2011/65/EU + AM-2015/863

EMC Compliance	Condition	Standard / Criterion
Electromagnetic compatibility of multimedia equipment – Emission Requirements	with external filter refer to “EMC Filtering”	EN55032:2015
Electromagnetic compatibility of multimedia equipment – Immunity requirements		EN55035:2017
Information technology equipment - Immunity characteristics - Limits and methods of measurement		EN55024:2010+A1:2015
ESD Electrostatic discharge immunity test	Contact: ±2, 4kV	IEC61000-4-2:2008, Criteria A EN61000-4-2:2009, Criteria A
Radiated, radio-frequency, electromagnetic field immunity test	3, 10V/m: (80-1000MHz); 3V/m: (1800, 2600, 3500, 5000MHz)	IEC/EN61000-4-3:2006+A2:2010, Criteria A
Fast Transient and Burst Immunity	DC Power Port: ±0.5, ±2kV	IEC/EN61000-4-4:2012, Criteria A
Surge Immunity	DC Power Port: ±0.5, ±1kV	IEC/EN61000-4-5:2014, Criteria A
Immunity to conducted disturbances, induced by radio-frequency fields	DC Power Port: 3Vr.m.s. (0.15-10MHz) 3-1Vr.m.s. (10-30MHz) 1Vr.m.s. (30-50MHz) 10Vr.m.s. (0.15-80MHz)	IEC61000-4-6:2013, Criteria A EN61000-4-6:2014, Criteria A
Power Magnetic Field Immunity	1A/m	IEC61000-4-8:2009 EN61000-4-8:2010
Limitations on the amount of electromagnetic interference allowed from digital and electronic devices	Class B	FCC 47 CFR Part 15 Subpart B

continued on next page

Specifications (measured @ Ta= 25°C, nom. Vin, full load and after warm-up unless otherwise stated)

EMC Filtering Suggestions according to EN55032 (9)

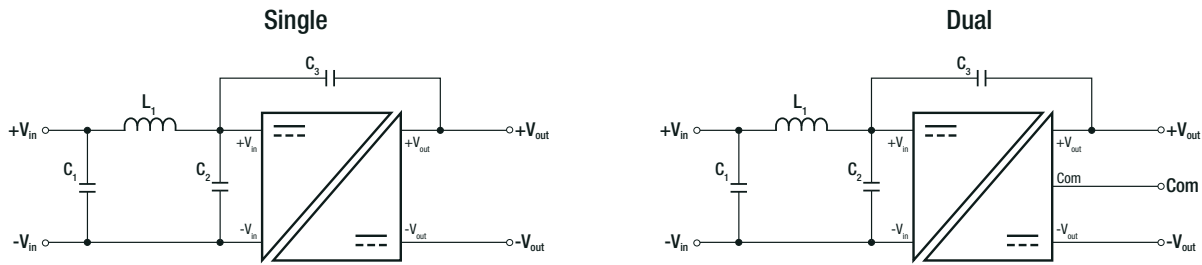

Component List Class A

MODEL	C1	C2	C3	L1
RSH3-1205S/SMD	10µF	N/A	N/A	3.9µH choke RLS-397
RSH3-2405S/SMD				
RSH3-2415D/SMD				

Component List Class B

MODEL	C1	C2	C3	L1
RSH3-1205S/SMD	10µF	10µF	1nF	3.9µH choke RLS-397
RSH3-2405S/SMD				
RSH3-2415S/SMD				

Notes:

Note9: Filter suggestions are valid for indicated part numbers only. For other part numbers, please contact RECOM for advice.

DIMENSION AND PHYSICAL CHARACTERISTICS

Parameter	Type	Value
Material	case & base	non-conductive black plastic, (UL94 V-0)
Dimension (LxWxH)		18.9 x 17.2 x 8.7mm
Weight		2.5g typ.

Dimension Drawing (mm)

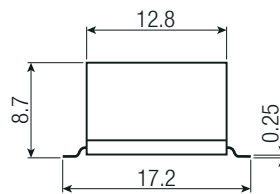
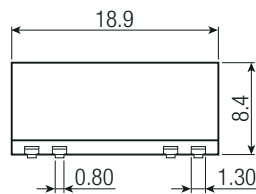
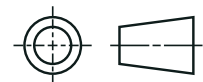
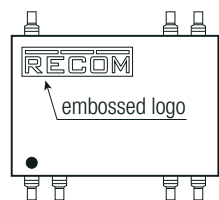

Pinning Information

Pin #	Single	Dual
1	-Vin	-Vin
2	CTRL	CTRL
6	NC	COM
7	NC	-Vout
8	+Vout	+Vout
9	-Vout	COM
14	+Vin	+Vin

NC= no connection

Tolerance:

xx.x= ±0.5mm

xx.xx= ±0.25mm

Recommended Footprint Details

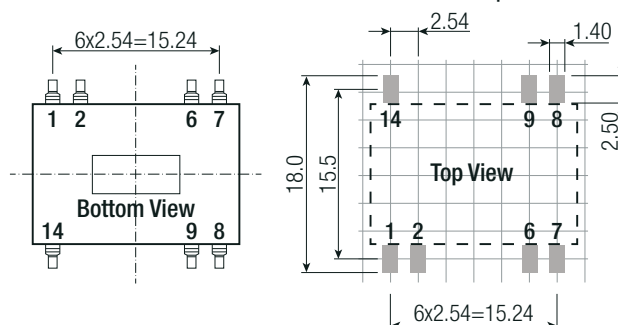

Specifications (measured @ Ta= 25°C, nom. Vin, full load and after warm-up unless otherwise stated)

PACKAGING INFORMATION		
Parameter	Type	Value
Packaging Dimension (LxWxH)	tube	520.0 x 22.20 x 11.80mm
	tape and reel (carton)	385.0 x 375.0 70.0mm
	reel (diameter + width)	Ø330.0 x 44.0mm
Packaging Quantity	tube	25pcs
	tape and reel	150pcs
Tape Width		44mm
Storage Temperature Range		-55°C to +125°C
Storage Humidity	non-condensing	95% RH max.

The product information and specifications may be subject to changes even without prior written notice. The product has been designed for various applications; its suitability lies in the responsibility of each customer. The products are not authorized for use in safety-critical applications without RECOM's explicit written consent. A safety-critical application is an application where a failure may reasonably be expected to endanger or cause loss of life, inflict bodily harm or damage property. The applicant shall indemnify and hold harmless RECOM, its affiliated companies and its representatives against any damage claims in connection with the unauthorized use of RECOM products in such safety-critical applications.