

Features

Regulated Converter

- 4:1 wide input range
- 3kVAC reinforced insulation for 110Vin
2.25kVDC basic insulation for 24Vin & 48Vin
- Efficiency up to 90%
- No minimum load required
- EN50155 certified
- IEC/EN60950-1 certified



RP120Q-RW

120 Watt
Quarter
Brick
Single Output



Description

The quarter brick RP120Q series DC/DC converters are designed for railway rolling stock and high voltage battery applications. Each series has three 4:1 input voltage range options to cover all input voltages from 9VDC up to 160VDC with isolated and regulated 5V to 48VDC outputs. The converters have high efficiencies and metal base-plates to permit a wide operating temperature range from -40°C to +85°C (when mounted on a suitable heatsink). The case is fitted with threaded inserts to allow secure mounting to the PCB or bulkhead for use in high shock and vibration environments. The converters are EN50155 and IEC/EN60950 certified. The RP120Q-RW series have a three year warranty.

Selection Guide

Part Number	Input Voltage Range [VDC]	Output Voltage [VDC]	Output Current [mA]	Input Current [mA]	Output Power [W]	Efficiency ⁽¹⁾ typ. [%]	Max. Capacitive Load [µF]
RP120Q-2405SRW	9-36	5	24000	5618	120	89	48000
RP120Q-2412SRW	9-36	12	10000	5682	120	88	8300
RP120Q-2415SRW	9-36	15	8000	5618	120	89	5300
RP120Q-2424SRW	9-36	24	5000	5682	120	88	2100
RP120Q-2448SRW	9-36	48	2500	5682	120	88	520
RP120Q-4805SRW	16.5-75	5	24000	2809	120	89	48000
RP120Q-4812SRW	16.5-75	12	10000	2809	120	89	8300
RP120Q-4815SRW	16.5-75	15	8000	2777	120	90	5300
RP120Q-4824SRW	16.5-75	24	5000	2777	120	90	2100
RP120Q-4848SRW	16.5-75	48	2500	2777	120	90	520
RP120Q-11005SRW	40-160	5	24000	1225	120	89	48000
RP120Q-11012SRW	40-160	12	11000	1363	132	88	9170
RP120Q-11015SRW	40-160	15	8600	1317	130	89	5730
RP120Q-11024SRW	40-160	24	5500	1348	132	89	2290
RP120Q-11048SRW	40-160	48	2700	1323	130	89	560



EN50155 certified
IEC/EN60950-1 certified

Notes:

Note1: Efficiency is tested by nominal Vin, full load and at 25°C

Model Numbering

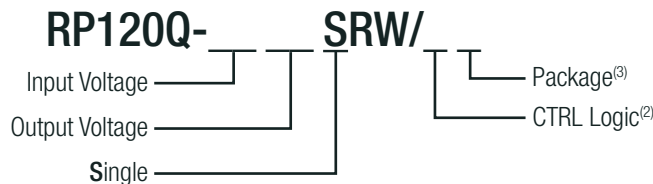

Notes:

Note2: standard part is with suffix "P" for positive logic (1=ON, 0=OFF) or add suffix "N" instead for negative logic (0=ON, 1=OFF) for more details refer to "ON/OFF CTRL (4)"

Note3: add suffix "-HC" for premounted Heat-sink (refer to "Dimension Drawing Heat-sink (mm)") (compatible with all other suffixes)

Ordering Examples

RP120Q-2405SRW/N = 24V Input, 5V Output, Single, Neg. CTRL function

RP120Q-11012SRW/P = 110V Input, 12V Output, Single, Pos. CTRL function

RP120Q-2405SRW/N-HC = 24V Input, 5V Output, Single, Neg. CTRL function, with premounted Heat-sink



<https://recom-power.com/rec-s-R-REF04-RIA12.html>



<https://recom-power.com/rec-s-RSPxxx-168.html>

Specifications (measured @Ta = 25°C, resistive load, nominal Vin and rated Iout unless otherwise noted)

BASIC CHARACTERISTICS					
Parameter	Condition		Min.	Typ.	Max.
Internal Input Filter					Pi-Type
Input Voltage Range	nom Vin = 24V nom Vin = 48V nom Vin = 110V		9VDC 16.5VDC 40VDC	24VDC 48VDC 110VDC	36VDC 75VDC 160VDC
Input Surge Voltage	Vin = 24V, 1s max. Vin = 48V, 1s max. Vin = 110V, 1s max.				50VDC 100VDC 185VDC
Under Voltage Lockout (UVLO)	Vin = 24V	DC-DC ON DC-DC OFF	7.3VDC		9VDC 8.1VDC
	Vin = 48V	DC-DC ON DC-DC OFF	15.5VDC		18VDC 16.3VDC
	Vin = 110V	DC-DC ON DC-DC OFF	33VDC		43VDC 36VDC
Quiescent Current	Vin = 24V Vin = 48V Vin = 110V			25mA 15mA 8mA	
Output Voltage Trimming	refer to "OUTPUT VOLTAGE TRIMMING"		-20%		+10%
Minimum Load			0%		
Start-up time	Power up, ON/OFF Control			75ms	100ms
ON/OFF CTRL ⁽⁴⁾ refer to "ON/OFF CTRL"	Positive Logic	DC-DC ON DC-DC OFF	Open or 3.0VDC < V _{CTRL} < 12VDC Short or 0VDC < V _{CTRL} < 1.2VDC		
	Negative Logic	DC-DC ON DC-DC OFF	Short or 0VDC < V _{CTRL} < 1.2VDC Open or 3.0VDC < V _{CTRL} < 12VDC		
Input Current of CTRL pin	drive current	I _{CTRL}	-0.5mA		1mA
Standby Current	DC-DC OFF	I _{in}		3mA	
Internal Operating Frequency			270kHz	300kHz	330kHz
Output Ripple and Noise	Measured by 20MHz BW with a 22µF/25V X7R MLCC with a 22µF/25V X7R MLCC with a 4.7µF/50V X7R MLCC with a 2.2µF/100V X7R MLCC	5 Vout 12, 15Vout 24Vout 48Vout		75mVp-p 100mVp-p 200mVp-p 300mVp-p	
Remote Sense	% of set Vout (refer to "REMOTE SENSE")				10%

Notes:

Note4: If fitted, the ON/OFF control function can be positive or negative logic. The pin voltage is referenced to -Vin

RP120Q-2405SRW

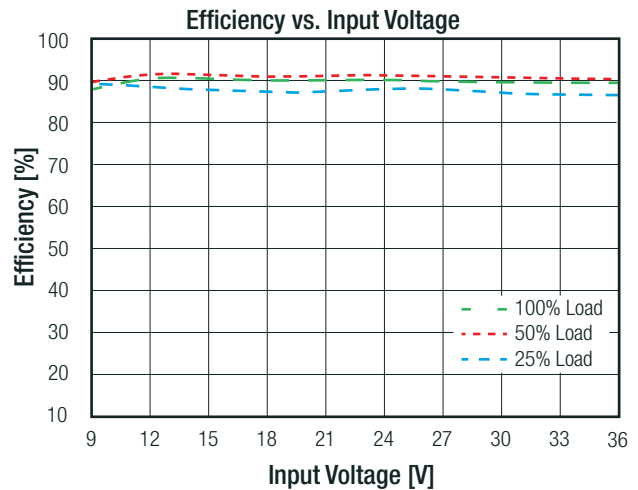
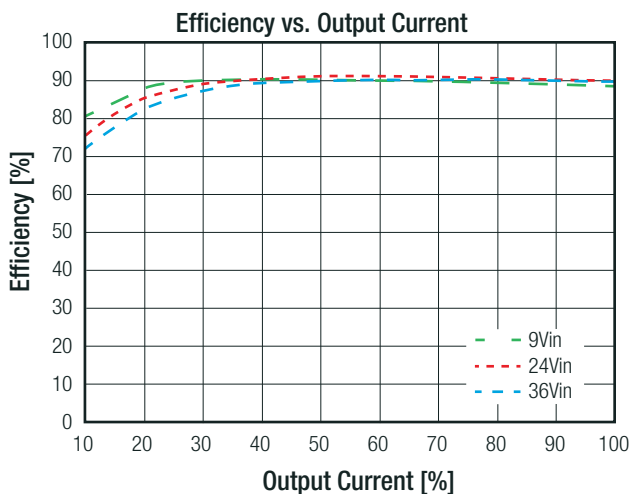

continued on next page

Specifications (measured @Ta = 25°C, resistive load, nominal Vin and rated Iout unless otherwise noted)

RP120Q-2405SRW

Power Dissipation vs. Output Current

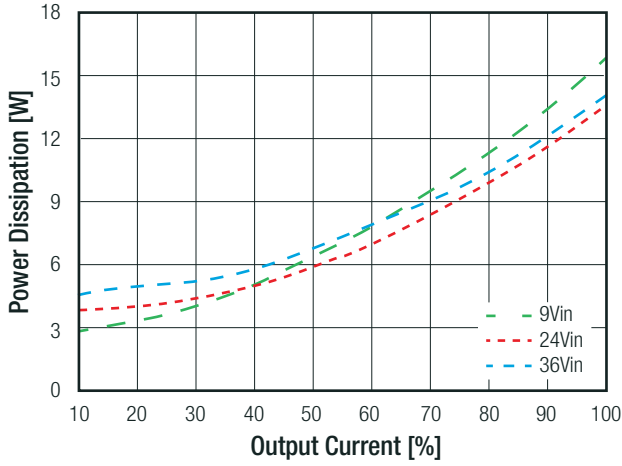

Typical Output Ripple and Noise/full load

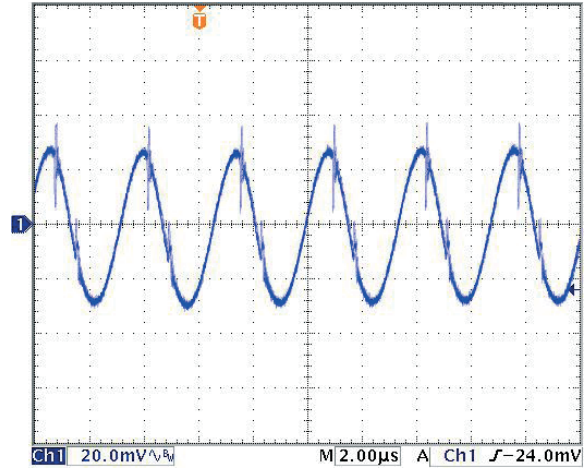

ON/OFF Control Start up Rise Characteristic

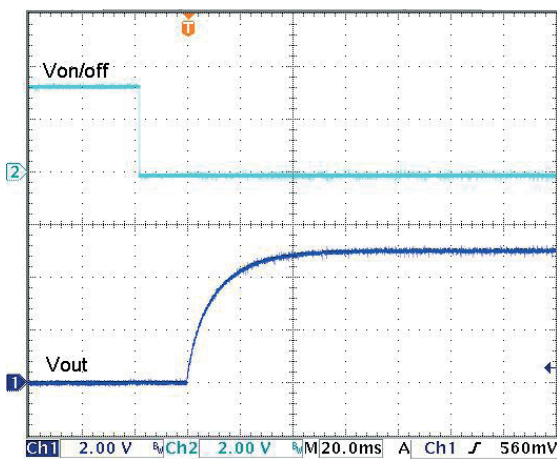

Power up Start-up Rise Characteristic

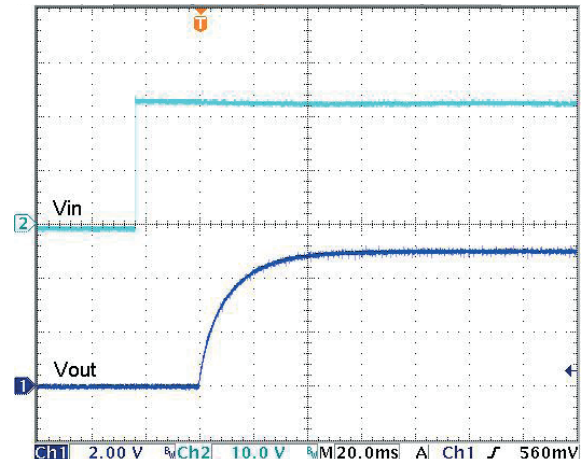

RP120Q-4805SRW

Efficiency vs. Output Current

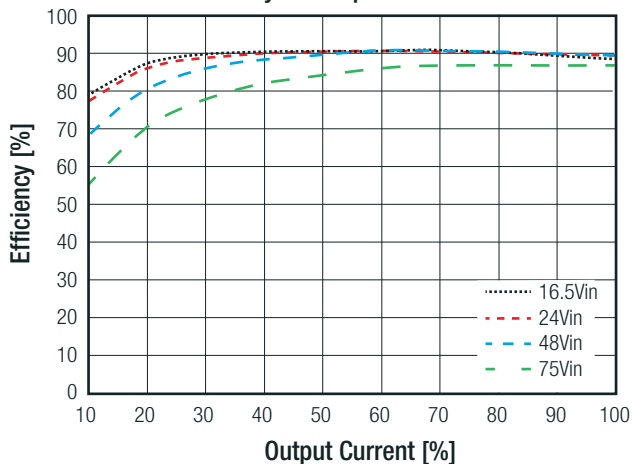

Efficiency vs. Input Voltage

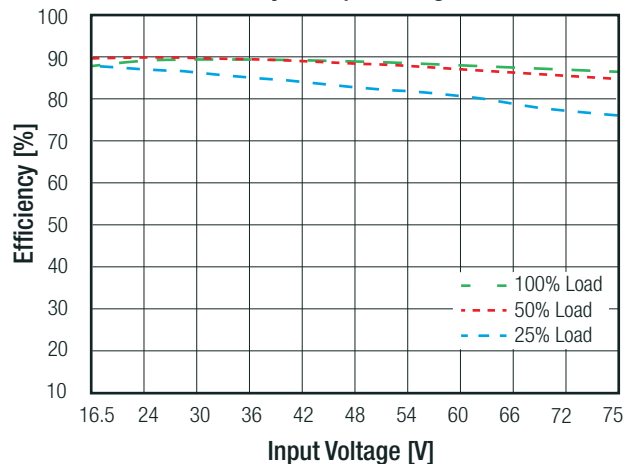

continued on next page

Specifications (measured @Ta = 25°C, resistive load, nominal Vin and rated Iout unless otherwise noted)

RP120Q-4805SRW

Power Dissipation vs. Output Current

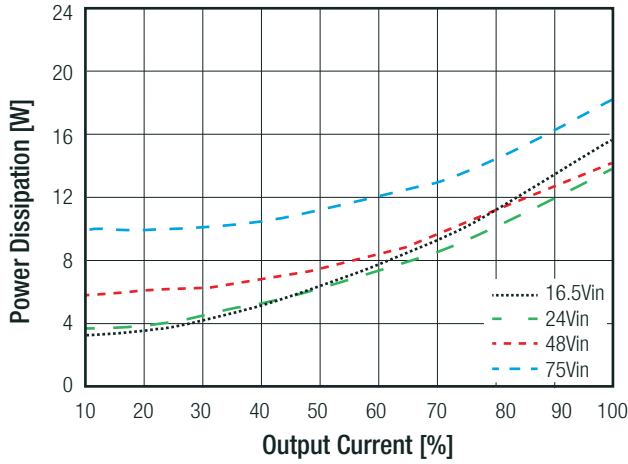

Typical Output Ripple and Noise/full load

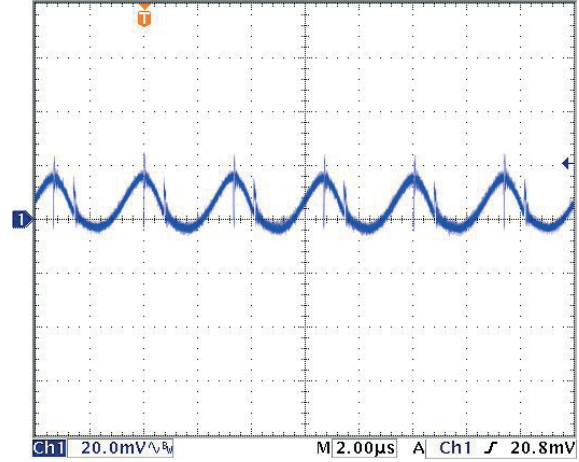

ON/OFF Control Start up Rise Characteristic

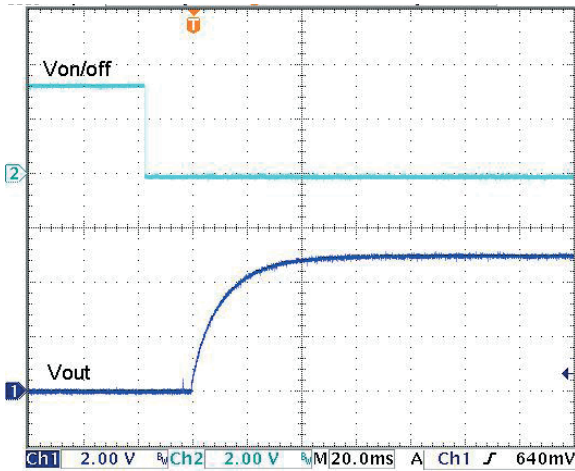

Power up Start-up Rise Characteristic

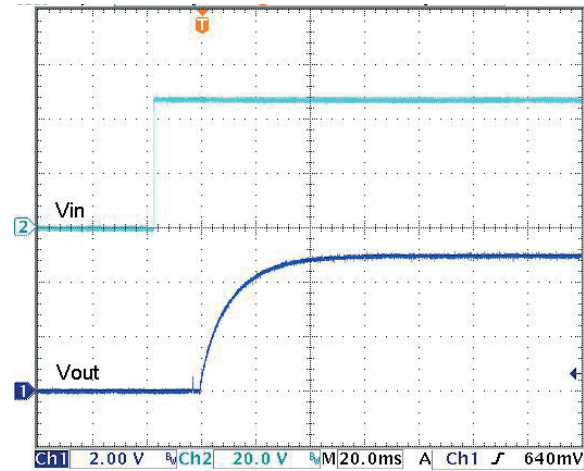

RP120Q-11005SRW

Efficiency vs. Output Current

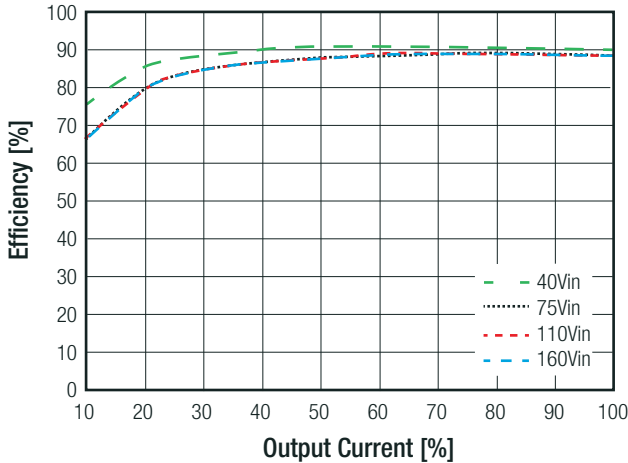

Efficiency vs. Input Voltage

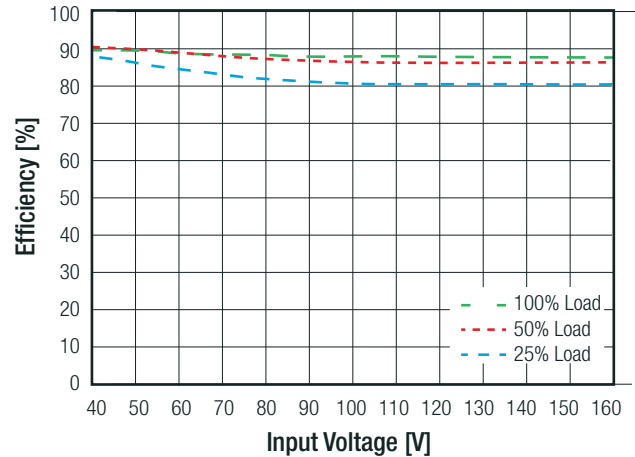

continued on next page

Specifications (measured @Ta = 25°C, resistive load, nominal Vin and rated Iout unless otherwise noted)

RP120Q-11005SRW

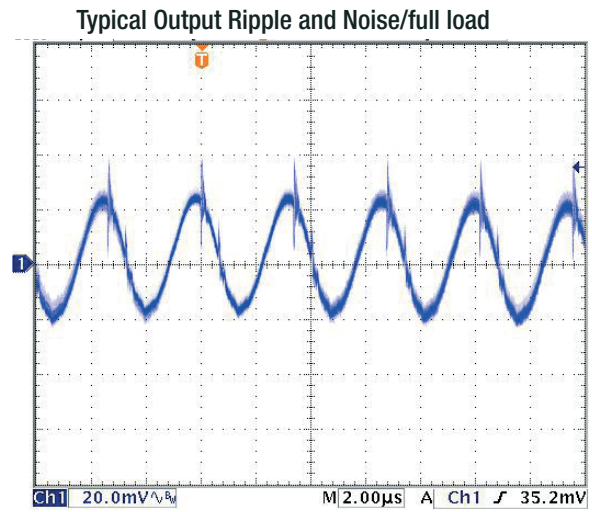
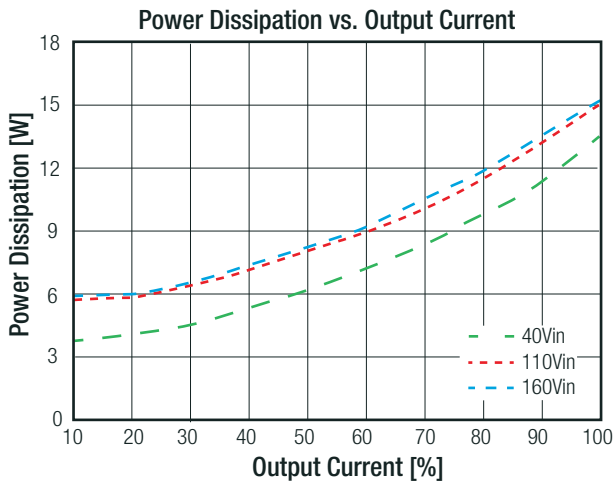

ON/OFF Control Start up Rise Characteristic

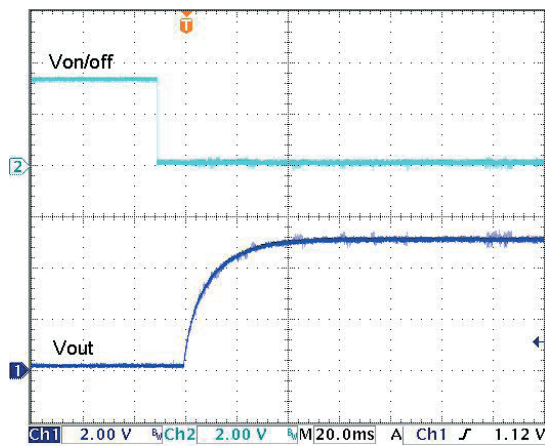

Power up Start-up Rise Characteristic

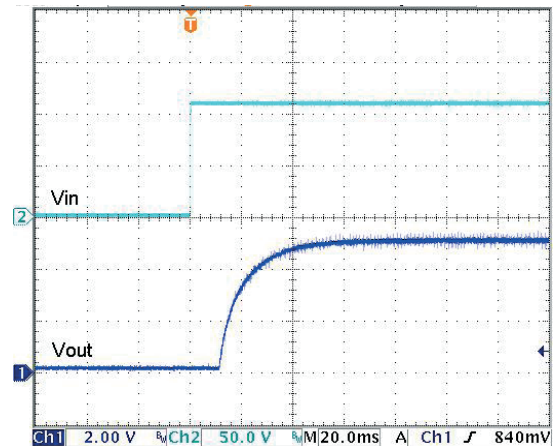

ON/OFF CTRL

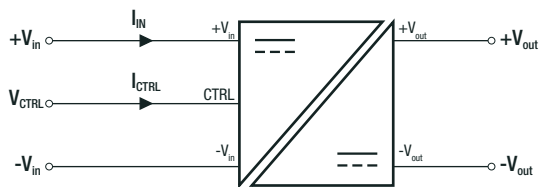

Positive Logic	DC-DC ON	Open or 3.0VDC < V _{CTRL} < 12VDC
	DC-DC OFF	Short or 0VDC < V _{CTRL} < 1.2VDC
Negativ Logic	DC-DC ON	Short or 0VDC < V _{CTRL} < 1.2VDC
	DC-DC OFF	Open or 3.0VDC < V _{CTRL} < 12VDC

REMOTE SENSE

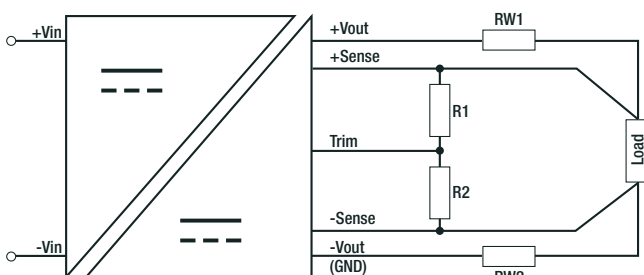

The output voltage can be adjusted by both trim and remote sense. The maximum combined adjustment range ±10%. Derate the maximum output power if using the trim or sense function.

- R_{W1} ... wire losses +
- R_{W2} ... wire losses -
- R₁ ... trim up resistor
- R₂ ... trim down resistor

OUTPUT VOLTAGE TRIMMING

Output Voltage Trimming

It allows the user to increase or decrease the output voltage of the module. This is accomplished by connecting an external resistor between the Trim pin and either the +Sense or -Sense pins. With an external resistor between the Trim and +Sense pin, the output voltage increases. With an external resistor between the Trim and -Sense pin, the output voltage decreases. The external Trim resistor needs to be at least 1/8W of rated. The values for trim resistors shown in trim tables below are according to standard E96 values; therefore, the specified voltage may slightly vary.

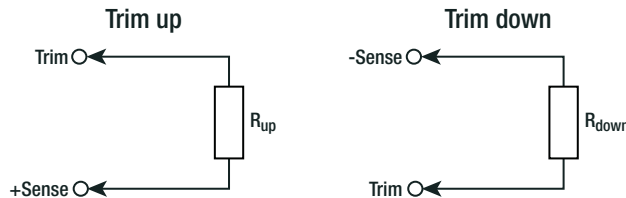

- Vout_{nom} = nominal output voltage [VDC]
- ΔVout = output voltage change [%]
- V_{ref} = reference voltage [VDC]
- R_{up} = trim up resistor [Ω]
- R_{down} = trim down resistor [Ω]
- R₁ & R₂ = internal resistors [Ω]

Vout _{nom}	R ₁	R ₂	R ₃	V _{ref}
5VDC	10k2Ω	511kΩ	5k11	1.225VDC
12VDC				
15VDC				
24VDC				
48VDC				

Calculation:

$$R_{up} = \left[\frac{R_3 \times V_{out_nom} \times (100 + \Delta Vout)}{V_{ref} \times \Delta Vout} \right] - \left[\frac{(R_1 \times \Delta Vout) + R_2}{\Delta Vout} \right]$$

$$R_{down} = \left[\frac{R_2}{\Delta Vout} \right] - R_1$$

Practical Example RP120Q-xx05SRW +10% / -10%

$$R_{up} = \left[\frac{5k11 \times 5 \times (100 + 10)}{1.225 \times 10} \right] - \left[\frac{(10k2 \times 10) + 511k}{10} \right] = 168k\Omega$$

$$R_{down} = \left[\frac{511k}{10} \right] - 10k2 = 40k9\Omega$$

R_{up} according to E96 ≈ **169kΩ**

R_{down} according to E96 ≈ **41k2Ω**

RP120Q-xx05SRW

Trim up	1	2	3	4	5	6	7	8	9	10	[%]
Vout _{set} =	5.05	5.10	5.15	5.20	5.25	5.30	5.35	5.4	5.45	5.50	[VDC]
R _{up} (E96) ≈	1M58	806k	536k	402k	324k	247k	237k	205k	187k	169k	[Ω]

RP120Q-xx12SRW

Trim up	1	2	3	4	5	6	7	8	9	10	[%]
Vout _{set} =	12.12	12.24	12.36	12.48	12.60	12.72	12.84	12.96	13.08	13.20	[VDC]
R _{up} (E96) ≈	4M53	2M26	1M54	1M15	931k	787k	681k	604k	536k	487k	[Ω]

RP120Q-xx15SRW

Trim up	1	2	3	4	5	6	7	8	9	10	[%]
Vout _{set} =	15.15	15.30	15.45	15.60	15.75	15.90	16.05	16.20	16.35	16.50	[VDC]
R _{up} (E96) ≈	5M76	2M94	1M96	1M50	1M21	1M02	866k	768k	698k	619k	[Ω]

RP120Q-xx24SRW

Trim up	1	2	3	4	5	6	7	8	9	10	[%]
Vout _{set} =	24.24	24.48	24.72	24.96	25.20	25.44	25.68	25.92	26.16	26.40	[VDC]
R _{up} (E96) ≈	9M53	4M87	3M24	2M94	2M00	1M69	1M47	1M27	1M15	1M05	[Ω]

continued on next page

Specifications (measured @Ta = 25°C, resistive load, nominal Vin and rated Iout unless otherwise noted)

RP120Q-xx48SRW

Trim up	1	2	3	4	5	6	7	8	9	10	[%]
Vout _{set} =	48.48	48.96	49.44	49.92	50.40	50.88	51.36	51.84	52.32	52.80	[VDC]
R _{up} (E96) ≈	19M6	9M945	6M65	5M11	4M12	3M48	3M01	2M61	2M37	2M15	[Ω]

Trim Down all Vout's

Trim down	1	2	3	4	5	6	7	8	9	10	[%]
R _{down} (E96) ≈	499k	243k	162k	118k	90k9	75k	63k4	53k6	46k4	41k2	[Ω]

Trim down	11	12	13	14	15	16	17	18	19	20	[%]
R _{down} (E96) ≈	36k5	32k4	28k7	26k1	23k7	21k5	19k6	18k2	16k5	15k4	[Ω]

REGULATIONS

Parameter	Condition	Value
Output Accuracy		±1.0%
Line Regulation	low line to high line at full load	±0.1%
Load Regulation	0% to 100% load	5Vout
		others
Transient Response	25% load step change	250µs typ.

Transient Response to Dynamic Load Change from 100% to 75% to 100% of Full Load at nom.Vin

RP120Q-2405SRW

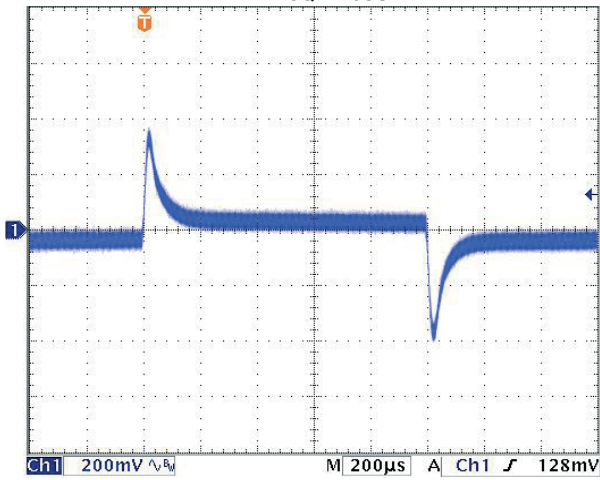

RP120Q-4805SRW

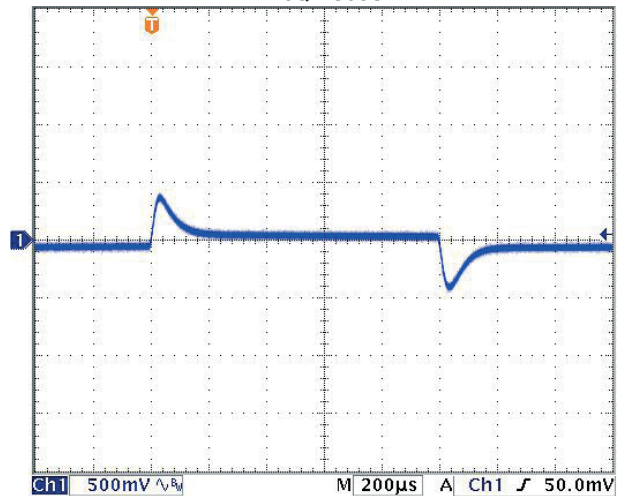

RP120Q-11005SRW

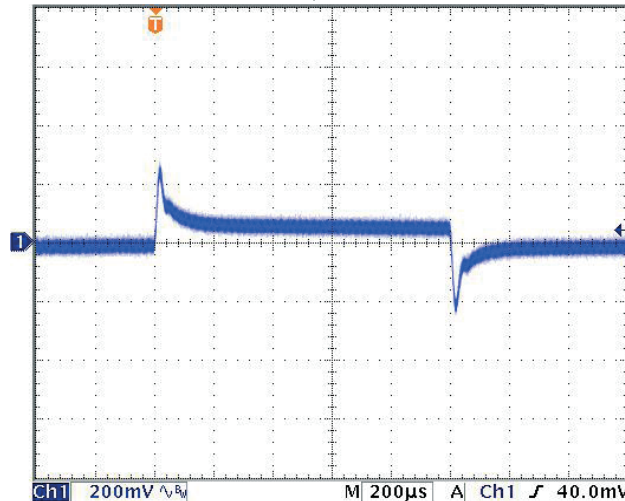

Specifications (measured @Ta = 25°C, resistive load, nominal Vin and rated Iout unless otherwise noted)

PROTECTIONS

Parameter	Condition		Value
Short Circuit Protection (SCP)	below 100mΩ		continuous, automatic recovery
Over Voltage Protection (OVP)	% of nom. Vout		115%-130%, Hiccup Mode
Over Load Protection (OLP)	% Iout rated		110%-140%, Hiccup Mode
Over Temperature Protection (OTP)			+110°C
Isolation Voltage	110Vin	I/P to O/P I/P or O/P to Baseplate	3kVAC/1minute 1.5kVAC/1minute
	24Vin, 48Vin	I/P to O/P I/P or O/P to Baseplate	2.25kVDC/1minute 2.25kVDC/1minute
Isolation Resistance	500 VDC		1GΩ min.
Isolation Capacitance			1500pF max.
Isolation Grade	110Vin		reinforced insulation
	24Vin, 48Vin		basic insulation

Notes:

Note5: Refer to local wiring regulations if input over-current protection is also required. Recommended fuse: T50A slow blow.

ENVIRONMENTAL

Parameter	Condition	Value
Operating Baseplate Temperature Range		refer to derating graph
Maximum Case Temperature		100°C
Temperature Coefficient		±0.02%/°C max.
Thermal Impedance	vertical direction by natural convection (0.1m/s) without Heat-sink	9°C/W
	vertical direction by natural convection (0.1m/s) with Heat-sink	7.1°C/W
Operating Humidity		5% - 95% RH
Pollution Degree		PD2
Shock		according to EN61373 standard
Thermal Shock		according to MIL-STD-810F standard
Vibration		according to EN61373 standard
Fire protection on railway vehicles		according to EN45545-2, 2013 standard
MTBF	according to MIL-HDBK-217F standard, 25°C	507.0 x 10 ³ hours

Thermal Calculation

$$R_{th\text{case-ambient}} = 9^\circ\text{C/W (vertical)}$$

$$R_{th\text{case-ambientHC}} = 7.1^\circ\text{C/W (vertical)}$$

$$R_{th\text{case-ambient}} = \frac{T_{\text{case}} - T_{\text{ambient}}}{P_{\text{dissipation}}}$$

$$P_{\text{dissipation}} = P_{\text{IN}} - P_{\text{OUT}} = \frac{P_{\text{OUTapp}}}{\eta} - P_{\text{OUTapp}}$$

- T_{case} = Case Temperature
- T_{ambient} = Environment Temperature
- P_{dissipation} = Internal losses
- P_{IN} = Input Power
- P_{OUT} = Output Power
- η = Efficiency under given Operating Conditions
- R_{thcase-ambient} = Thermal Impedance

Practical Example:

Take the RP120Q-2405SRW with 9V input Voltage and 50% load. What is the maximum ambient operating temperature? Use converter vertical in application without airflow.

$$Eff_{\text{min}} = 91\% @ V_{\text{nom}}$$

$$P_{\text{OUT}} = 120\text{W}$$

$$P_{\text{OUTapp}} = 120 \times 0.5 = 60\text{W}$$

$$\eta = 91\% \text{ (Efficiency vs. Load Graph)}$$

$$P_{\text{dissipation}} = \frac{60}{0.91} - 60 = 5.93\text{W}$$

without Heat-sink

$$R_{\text{th}} = \frac{T_{\text{casemax}} - T_{\text{amb}}}{P_{\text{dissipation}}} \rightarrow 9^\circ\text{C/W} = \frac{100 - T_{\text{amb}}}{5.93\text{W}}$$

$$T_{\text{amb}} = 46^\circ\text{C}$$

with Heat-sink

$$R_{\text{thHC}} = \frac{T_{\text{casemax}} - T_{\text{amb}}}{P_{\text{dissipation}}} \rightarrow 7.5^\circ\text{C/W} = \frac{100 - T_{\text{amb}}}{5.93\text{W}}$$

$$T_{\text{ambHC}} = 57^\circ\text{C}$$

continued on next page

Specifications (measured @Ta = 25°C, resistive load, nominal Vin and rated Iout unless otherwise noted)

Derating Graph⁽⁶⁾

(@ Chamber - tested with forced convection)

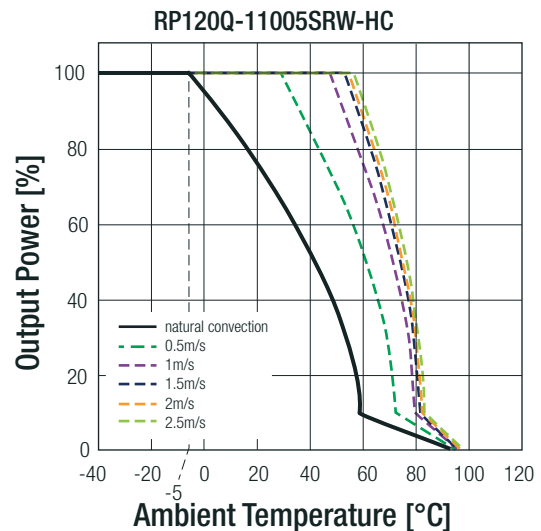
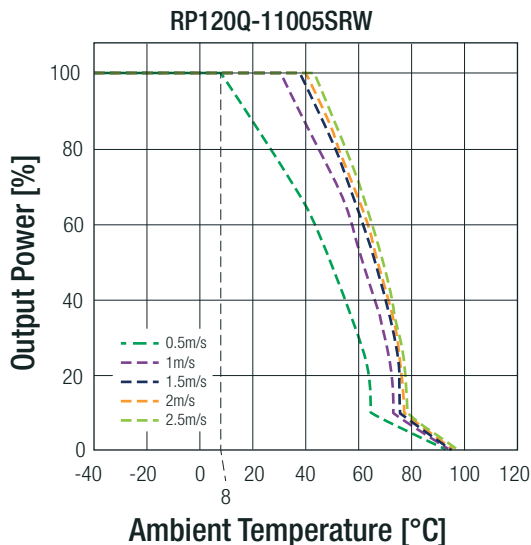
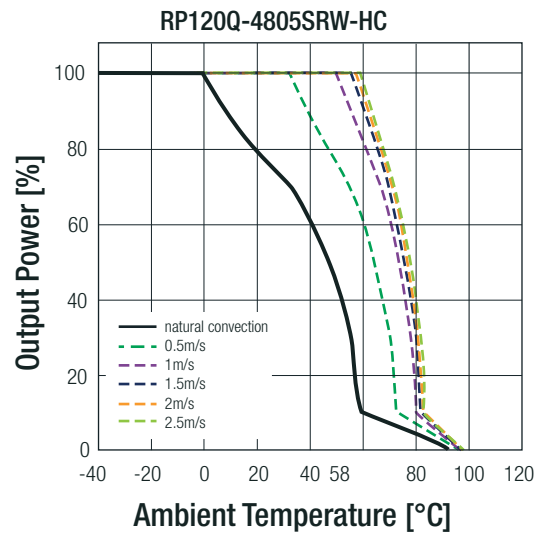
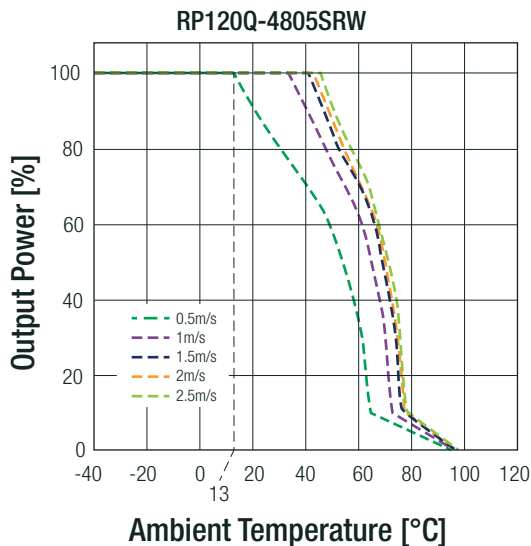
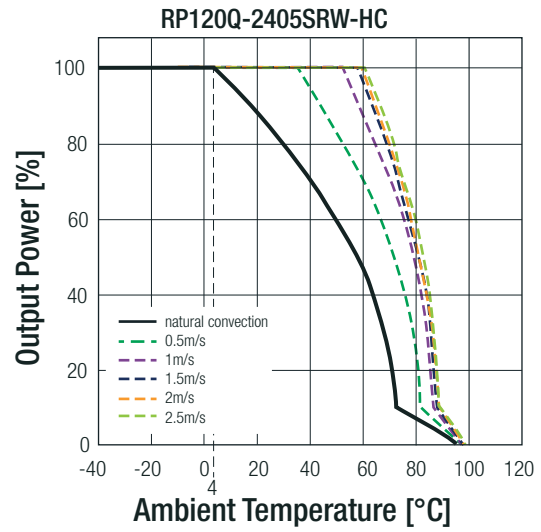
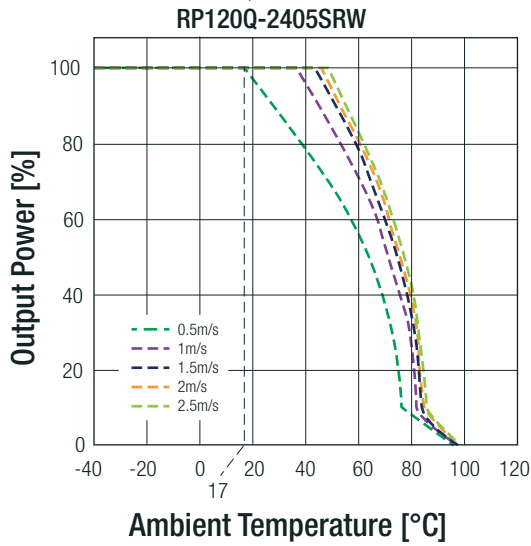

Notes:

Note6: Derating graphs are valid only for the shown part numbers. If you need detailed derating-information about a part-number not shown here please contact our technical support service at techsupportAT@recom-power.com

Specifications (measured @Ta = 25°C, resistive load, nominal Vin and rated Iout unless otherwise noted)

SAFETY AND CERTIFICATIONS

Certificate Type (Safety)	Report / File Number	Standard
Information Technology Equipment - General Requirements for Safety	TW1608086-001	IEC60950-1, 2nd Edition, 2005 EN60950-1:2006
Railway Applications - Electrical Equipment used on rolling stock	TW1608078-001	EN50155, 2007
EAC	RU-AT.49.09571	TP TC 004/2011
RoHS 2+		RoHS 2011/65/EU

EMI Compliance	Condition	Standard / Criterion
Information technology equipment - Radio disturbance characteristics - Limits and methods of measurement	with external filter	EN55032, Class A and Class B
Industrial, scientific and medical equipment - Radio frequency disturbance characteristics - Limits and methods of measurement		EN55011, Class A and Class B
ESD Electrostatic discharge immunity test	Air ±8kV and Contact ±6kV 20 V/m ±2kV ±2kV 10 Vr.m.s 100A/m continuous; 1000A/m 1s	EN61000-4-2, Criteria A
Radiated, radio-frequency, electromagnetic field immunity test		EN61000-4-3, Criteria A
Fast Transient and Burst Immunity ⁽⁷⁾		EN61000-4-4, Criteria A
Surge Immunity ⁽⁷⁾		EN61000-4-5, Criteria A
Immunity to conducted disturbances, induced by radio-frequency fields		EN61000-4-6, Criteria A
Power Magnetic Field Immunity		EN61000-4-8, Criteria A

Notes:

Note7: An external input filter capacitor is required if the module has to meet EN61000-4-4 and EN61000-4-5

The **24Vin** and **48Vin** version recommend 2pcs of aluminium electrolytic capacitor to connect in parallel
Recom suggest: Nippon Chemi-con KY series, 220µF/100V.

The **110Vin** version recommend 2pcs of aluminium electrolytic capacitor to connect in parallel
Recom suggest: Nippon Chemi-con KXJ series, 150µF/200V

EMI Filtering according to EN55032/11 Class A and EN50121-1 (24Vin and 48Vin)

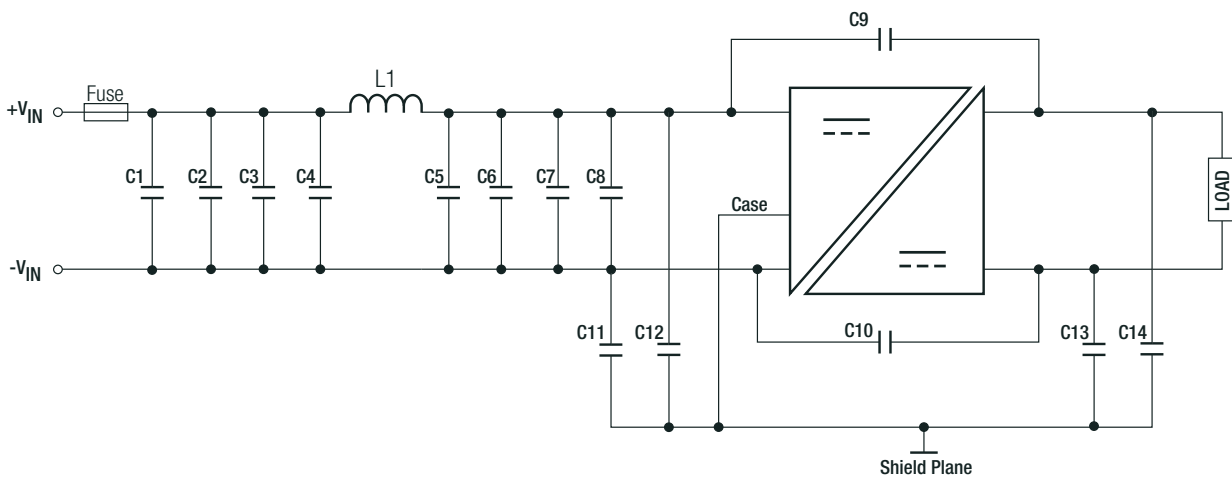

MODEL	C1	C2, C3, C4	C5	C6, C7, C8	C9 to C14	L1
RP120Q-24xxSRW	N/A	6.8µF, 50V 1812 MLCC	N/A	6.8µF, 50V 1812 MLCC	1000pF, 3kV 1808 MLCC	0.68µH, 17A SMD Inductor
RP120Q-48xxSRW	4.7µF, 100V 1812 MLCC	4.7µF, 100V 1812 MLCC	4.7µF, 100V 1812 MLCC	4.7µF, 100V 1812 MLCC	1000pF, 3kV 1808 MLCC	3.3µH, 10A SMD Inductor

continued on next page

Specifications (measured @Ta = 25°C, resistive load, nominal Vin and rated Iout unless otherwise noted)

RP120Q-2405SRW

Conducted Emission EN55032 Class A

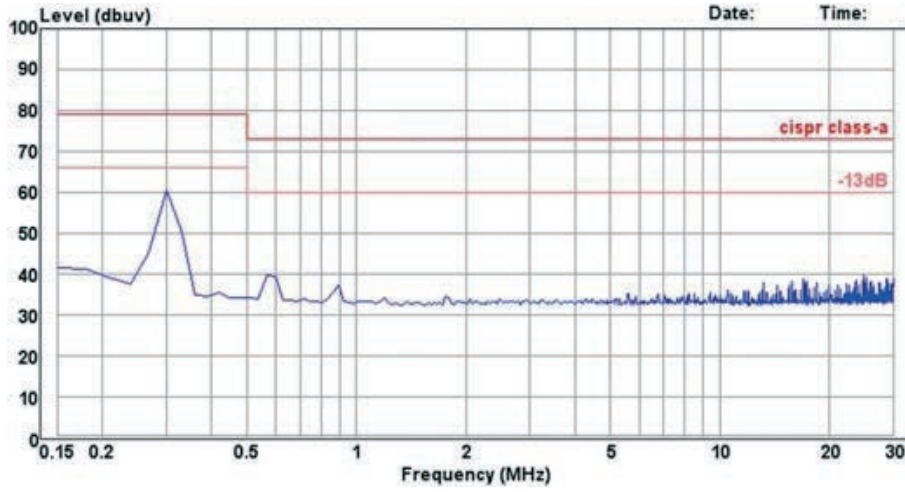

RP120Q-4805SRW

Conducted Emission EN55032 Class A

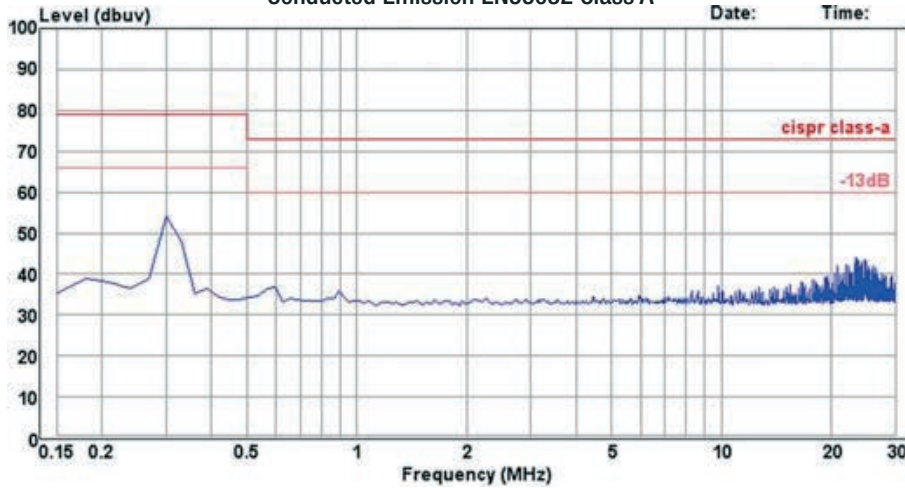

EMI Filtering according to EN55032/11 Class A and EN50121-1 (110Vin)

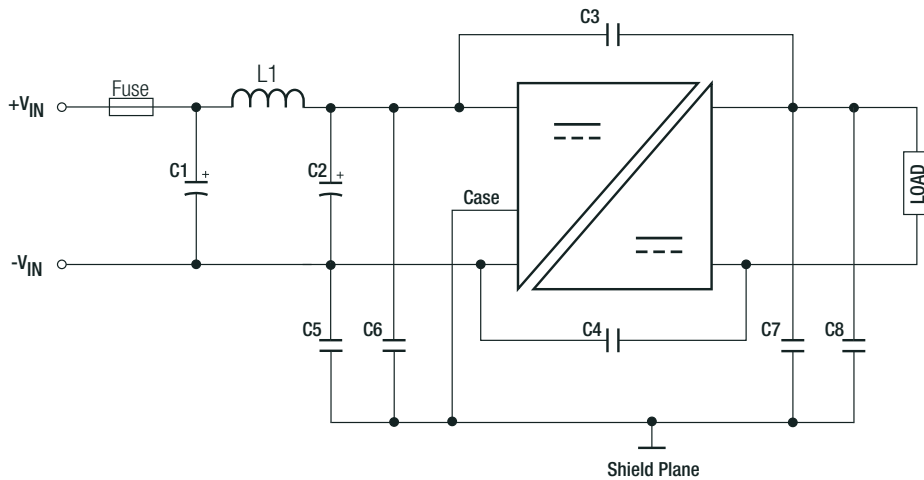

MODEL	C1, C2	C3 to C8	L1
RP120Q-110xxSRW	39µF, 250V Al cap. (lie down)	1000pF, 3kV 1808 MLCC	30.1µH, 5A SMD Inductor

continued on next page

Specifications (measured @Ta = 25°C, resistive load, nominal Vin and rated Iout unless otherwise noted)

RP120Q-11005SRW

Conducted Emission EN55032 Class A

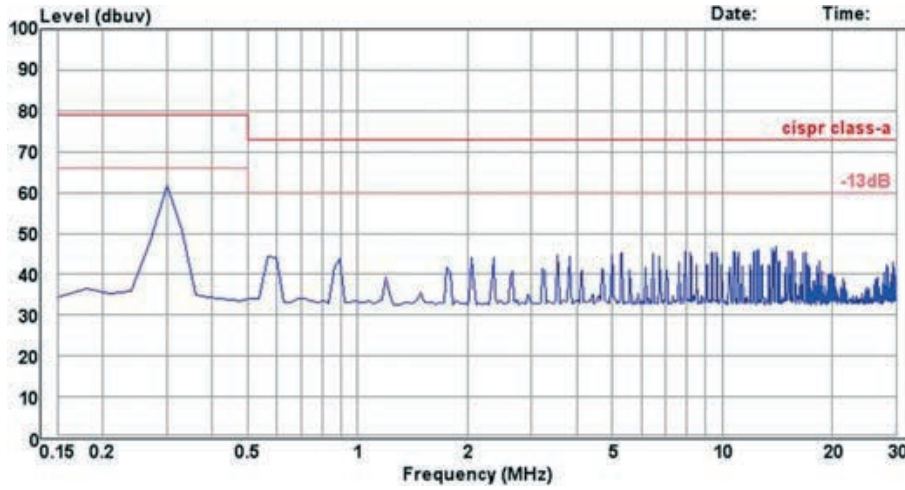

EMI Filtering according to EN55032/11 Class B (24Vin)

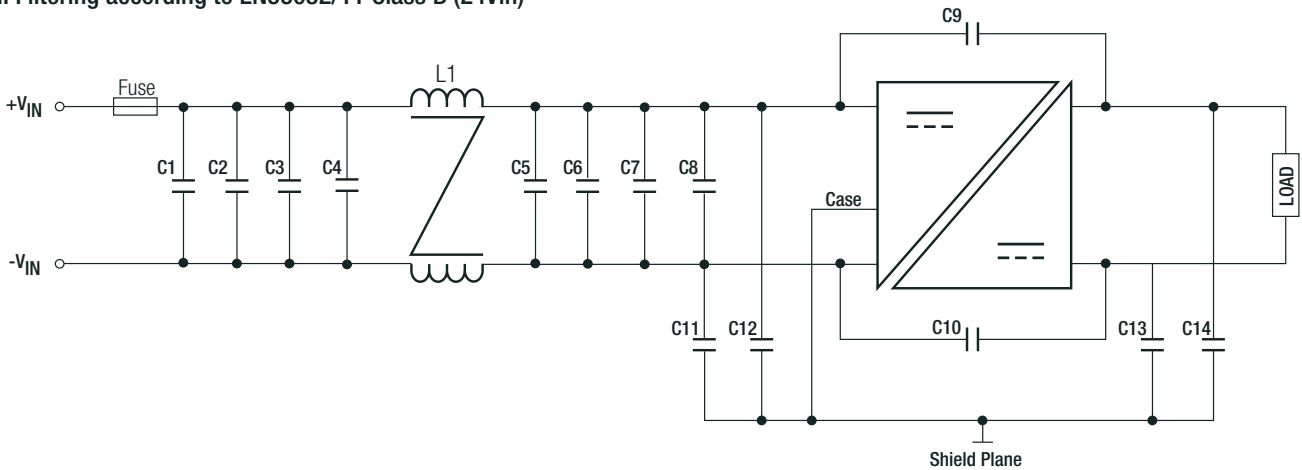

MODEL	C1 to C8	C9, C10, C13, C14	C11, C12	L1
RP120Q-24xxSRW	10µF, 50V 1812 MLCC	1000pF, 3kV 1808 MLCC	2200pF, 3kV 1812 MLCC	285µH CMC

RP120Q-2405SRW

Conducted Emission EN55032 Class B

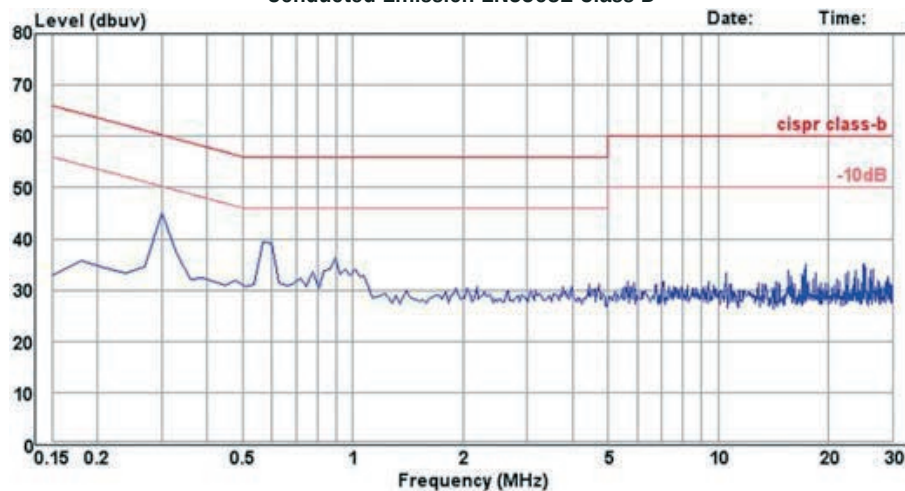

continued on next page

Specifications (measured @Ta = 25°C, resistive load, nominal Vin and rated Iout unless otherwise noted)

EMI Filtering according to EN55032/11 Class B (48Vin)

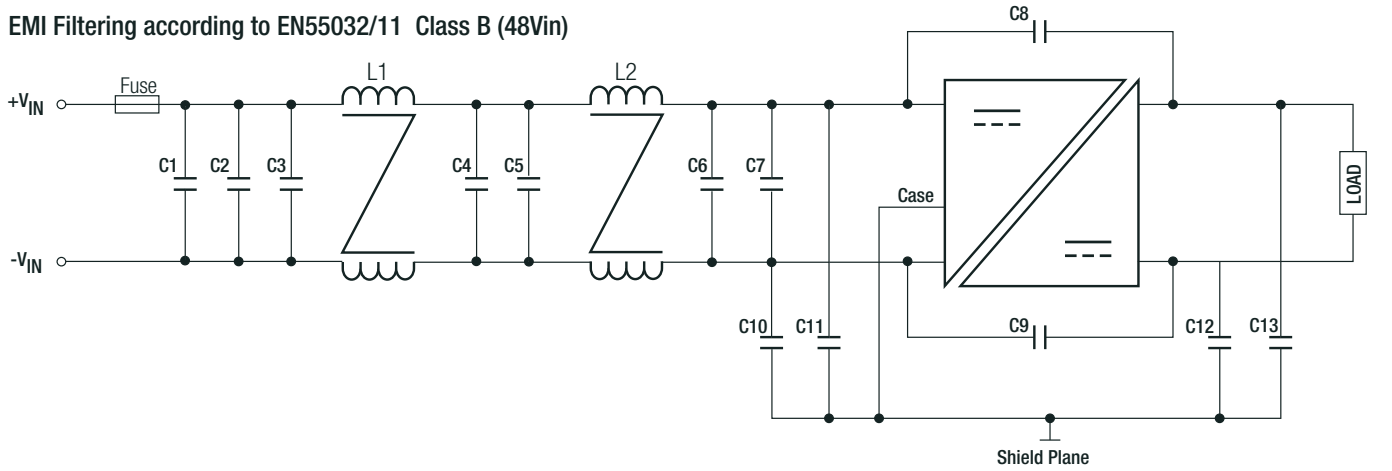

MODEL	C1 to C7	C8 to C13	L1	L2
RP120Q-48xxSRW	4.7µF, 100V 1812 MLCC	1000pF, 3kV 1808 MLCC	620µH CMC	285µH CMC

RP120Q-4805SRW

Conducted Emission EN55032 Class B

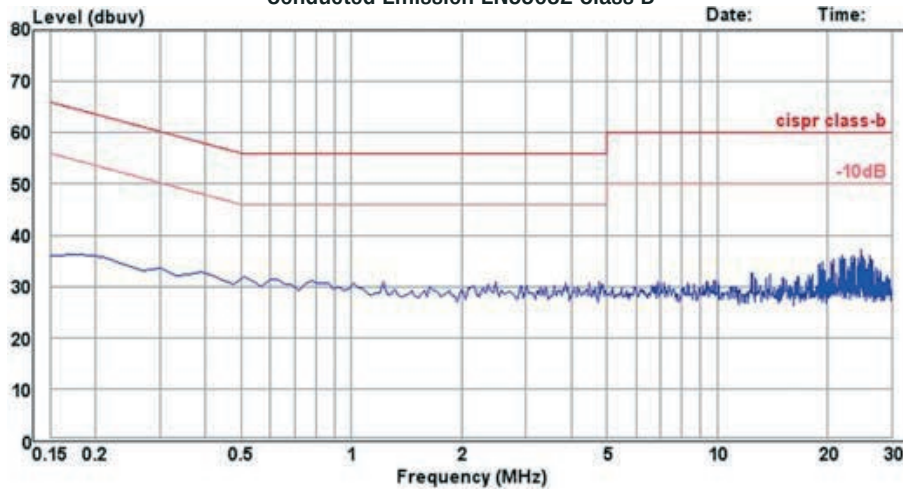

EMI Filtering according to EN55032/11 Class B (110Vin)

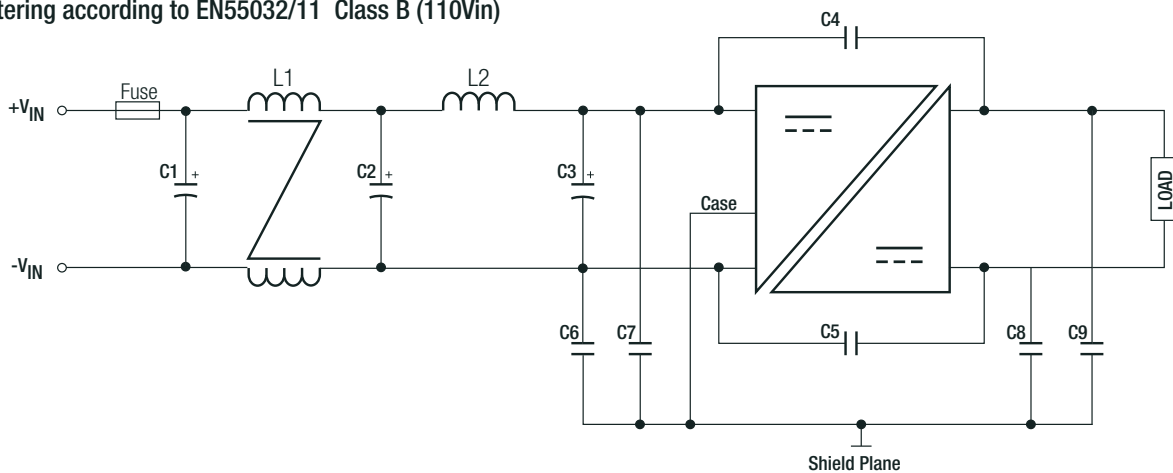

MODEL	C1, C2, C3	C4 to C9	L1	L2
RP120Q-110xxSRW	39µF, 250V Al cap. (lie down) Rubycon BXF	1000pF, 3kV 1808 MLCC	735µH CMC	30.1µH, 5A SMD Inductor

continued on next page

Specifications (measured @Ta = 25°C, resistive load, nominal Vin and rated Iout unless otherwise noted)

RP120Q-110xxSRW

Conducted Emission EN55032 Class B

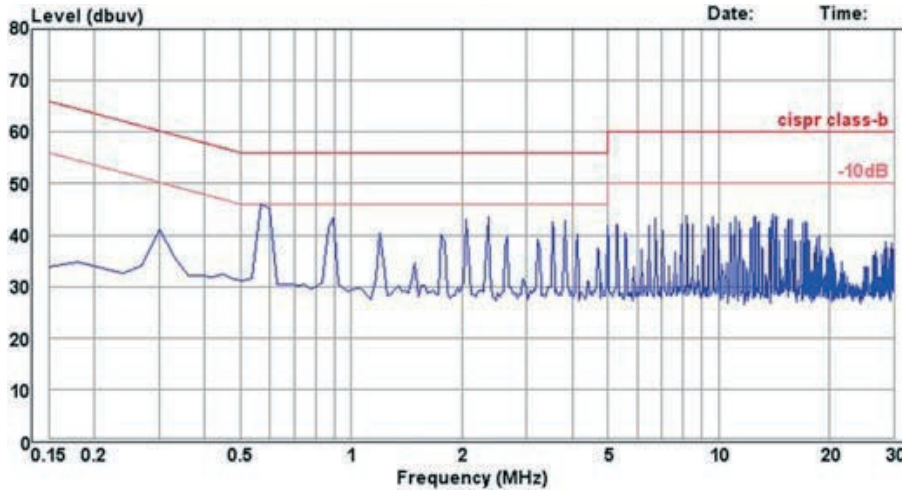

DIMENSIONS and PHYSICAL CHARACTERISTICS

Parameter	Type	Value
Material	case	plastic
	baseplate	aluminium
	potting	silicone (JL94 V-0)
Dimensions (LxWxH)	without Heat-sink	57.9 x 36.6 x 12.7mm
	with Heat-sink	57.9 x 36.6 x 18.8mm
Weight	without Heat-sink	64g
	with Heat-sink	88g

Dimension Drawing Heat-sink (mm)

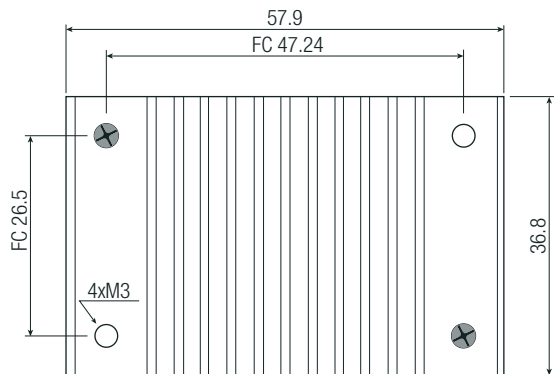
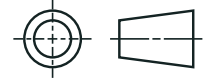

Notes:

Note8: Max. tightening torque for Heat-sink: 0.34Nm

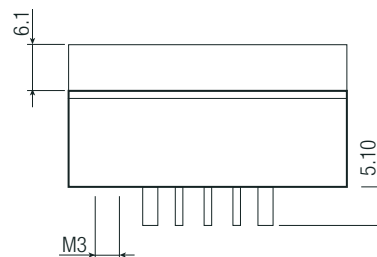
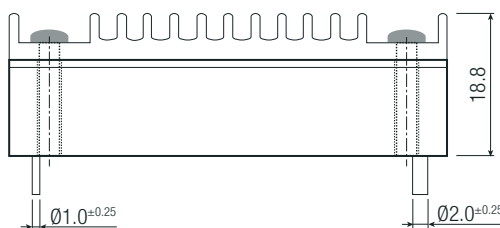

continued on next page

Specifications (measured @Ta = 25°C, resistive load, nominal Vin and rated Iout unless otherwise noted)

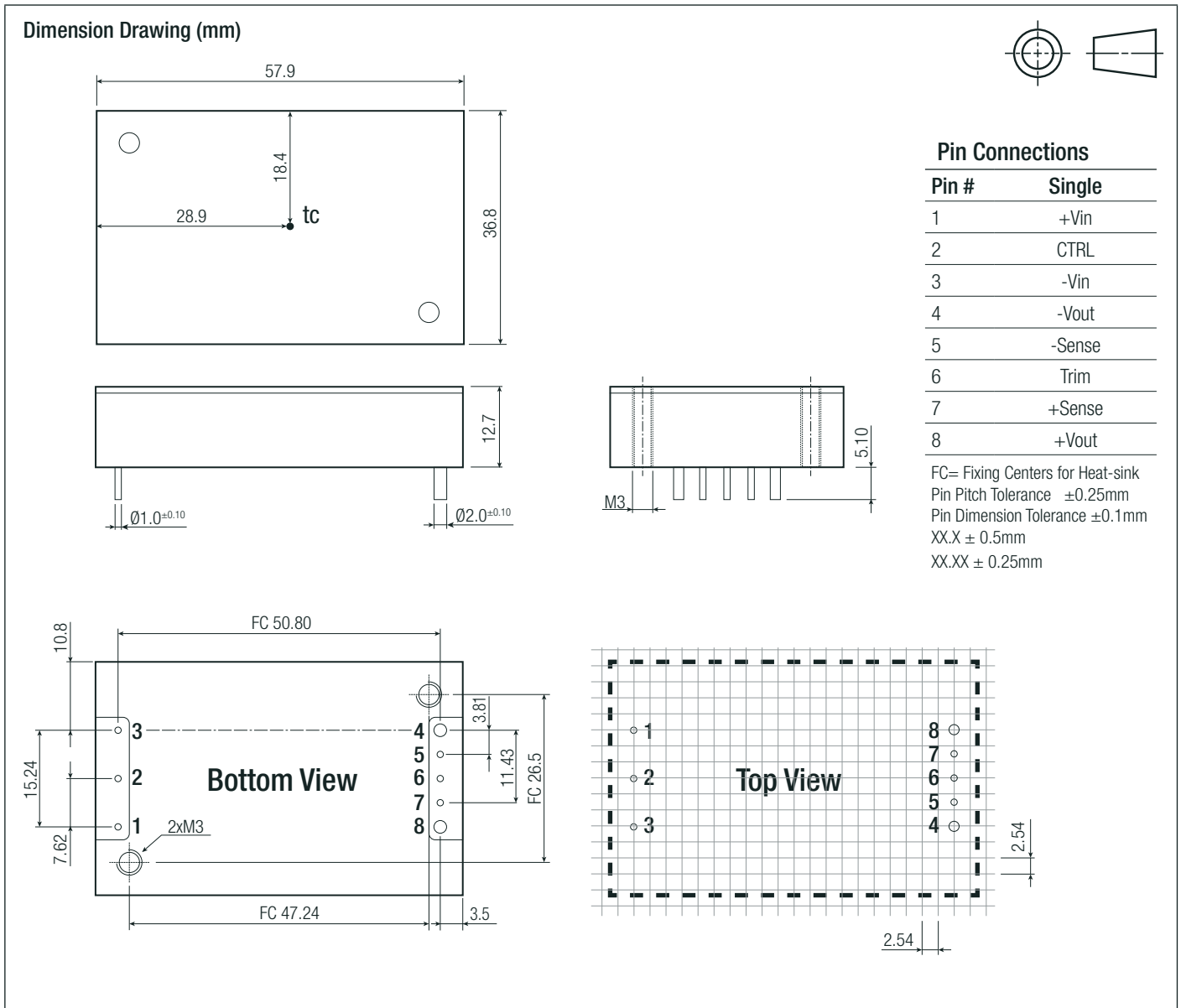

PACKAGING INFORMATION

Parameter	Type		Value
Packaging Dimension	tray	without Heat-sink with Heat-sink	157.0 x 88.0 x 23.0mm 157.0 x 88.0 x 35.0mm
Packaging Quantity			2pcs
Storage Temperature Range			-55°C to +125°C
Storage Humidity			5% - 95% RH

The product information and specifications may be subject to changes even without prior written notice. The product has been designed for various applications; its suitability lies in the responsibility of each customer. The products are not authorized for use in safety-critical applications without RECOM's explicit written consent. A safety-critical application is an application where a failure may reasonably be expected to endanger or cause loss of life, inflict bodily harm or damage property. The applicant shall indemnify and hold harmless RECOM, its affiliated companies and its representatives against any damage claims in connection with the unauthorized use of RECOM products in such safety-critical applications.