



100N03NF

N-Ch 30V Fast Switching MOSFETs

Description

The 100N03NF is the high cell density trenched N-ch MOSFETs, which provide excellent RDSON and gate charge for most of the synchronous buck converter applications.

The 100N03NF meet the RoHS and Green Product requirement, 100% EAS guaranteed with full function reliability approved.

Super Low Gate Charge

100% EAS Guaranteed

Green Device Available

Excellent CdV/dt effect decline

Advanced high cell density Trench technology

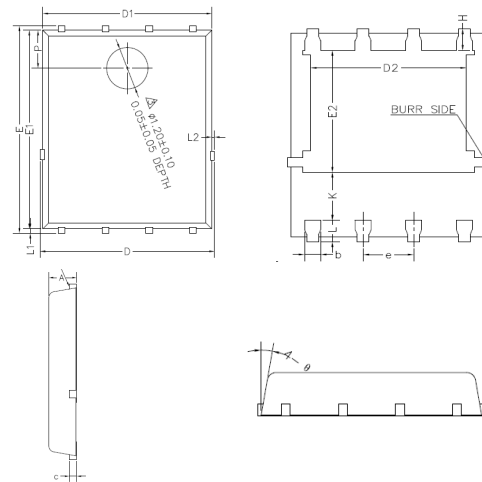
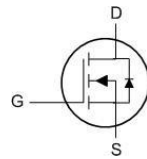
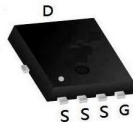

PDFN5X6

Product Summary

BVDSS	RDSON	ID
30V	3.5mΩ	100A

Dimensions In Millimeters

SYMBOL	min	max	SYMBOL	min	max	SYMBOL	min	max
A	0.95	1.20	E	5.9	6.1	L2		0.2
b	0.25	0.40	E1	5.7	5.8	θ		13°
c	0.21	0.34	E2	3.34	3.54	P	1.0	1.2
D		5.1	H	0.51	0.71			
D1	4.8	5.0	K	1.1				
D2	3.91	4.20	L	0.51	0.71			
e	1.17	1.37	L1	0.06	0.2			

Absolute Maximum Ratings

Symbol	Parameter	Rating		Units
		10s	Steady State	
V _{DS}	Drain-Source Voltage	30		V
V _{GS}	Gate-Source Voltage	±20		V
I _D @T _C =25°C	Continuous Drain Current, V _{GS} @ 10V ¹	100		A
I _D @T _C =100°C	Continuous Drain Current, V _{GS} @ 10V ¹	50		A
I _D @T _A =25°C	Continuous Drain Current, V _{GS} @ 10V ¹	30	19	A
I _D @T _A =70°C	Continuous Drain Current, V _{GS} @ 10V ¹	25	16	A
I _{DM}	Pulsed Drain Current ²	162		A
EAS	Single Pulse Avalanche Energy ³	144.7		mJ
I _{AS}	Avalanche Current	53.8		A
P _D @T _C =25°C	Total Power Dissipation ⁴	62.5		W
P _D @T _A =25°C	Total Power Dissipation ⁴	6	2.42	W
T _{STG}	Storage Temperature Range	-55 to 175		°C
T _J	Operating Junction Temperature Range	-55 to 175		°C

Thermal Data

Symbol	Parameter	Typ.	Max.	Unit
R _{θJA}	Thermal Resistance Junction-Ambient ¹	---	62	°C/W
R _{θJA}	Thermal Resistance Junction-Ambient ¹ (t ≤ 10s)	---	25	°C/W
R _{θJC}	Thermal Resistance Junction-Case ¹	---	2.4	°C/W

100N03NF

Electrical Characteristics ($T_J=25^{\circ}\text{C}$ unless otherwise specified)

Symbol	Parameter	Test Condition	Min.	Typ.	Max.	Units
$V_{(BR)DSS}$	Drain-Source Breakdown Voltage	$V_{GS}=0V, I_D=250\mu A$	30	-	-	V
I_{DSS}	Zero Gate Voltage Drain Current	$V_{DS}=30V, V_{GS}=0V,$	-	-	1.0	μA
I_{GSS}	Gate to Body Leakage Current	$V_{DS}=0V, V_{GS}=\pm 20V$	-	-	± 100	nA
$V_{GS(th)}$	Gate Threshold Voltage	$V_{DS}=V_{GS}, I_D=250\mu A$	1.0	1.5	2.5	V
$R_{DS(on)}$	Static Drain-Source on-Resistance <small>note3</small>	$V_{GS}=10V, I_D=30A$	-	3.5	4.7	m Ω
		$V_{GS}=4.5V, I_D=20A$	-	7.0	10	
C_{iss}	Input Capacitance	$V_{DS}=15V, V_{GS}=0V,$ $f=1.0\text{MHz}$	-	2100	-	pF
C_{oss}	Output Capacitance		-	326	-	pF
C_{rss}	Reverse Transfer Capacitance		-	282	-	pF
Q_g	Total Gate Charge	$V_{DS}=15V, I_D=30A,$ $V_{GS}=10V$	-	45	-	nC
Q_{gs}	Gate-Source Charge		-	3	-	nC
Q_{gd}	Gate-Drain("Miller") Charge		-	15	-	nC
$t_{d(on)}$	Turn-on Delay Time	$V_{DS}=15V,$ $I_D=30A, R_{GEN}=3\Omega,$ $V_{GS}=10V$	-	21	-	ns
t_r	Turn-on Rise Time		-	32	-	ns
$t_{d(off)}$	Turn-off Delay Time		-	59	-	ns
t_f	Turn-off Fall Time		-	34	-	ns
I_S	Maximum Continuous Drain to Source Diode Forward Current		-	-	50	A
I_{SM}	Maximum Pulsed Drain to Source Diode Forward Current		-	-	200	A
V_{SD}	Drain to Source Diode Forward Voltage	$V_{GS}=0V, I_S=30A$	-	-	1.2	V
t_{rr}	Body Diode Reverse Recovery Time	$I_F=20A, di/dt=100A/\mu s$	-	15	-	ns
Q_{rr}	Body Diode Reverse Recovery Charge		-	4	-	nC

Notes: 1. Repetitive Rating: Pulse Width Limited by Maximum Junction Temperature

2. EAS condition: $T_J=25^{\circ}\text{C}, V_G=10V, R_G=25\Omega, L=0.5\text{mH}, I_{AS}=18.4A$

3. Pulse Test: Pulse Width $\leq 300\mu s$, Duty Cycle $\leq 0.5\%$

RATING AND CHARACTERISTIC CURVES (100N03NF)

Figure 1: Output Characteristics

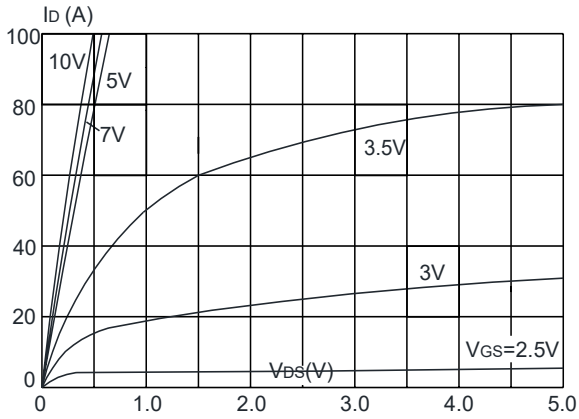

Figure 2: Typical Transfer Characteristics

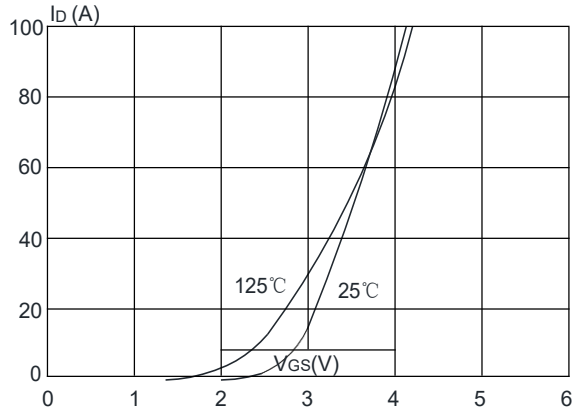

Figure 3: On-resistance vs. Drain Current

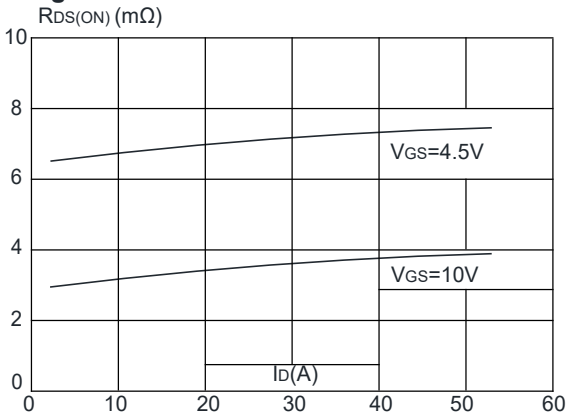

Figure 4: Body Diode Characteristics

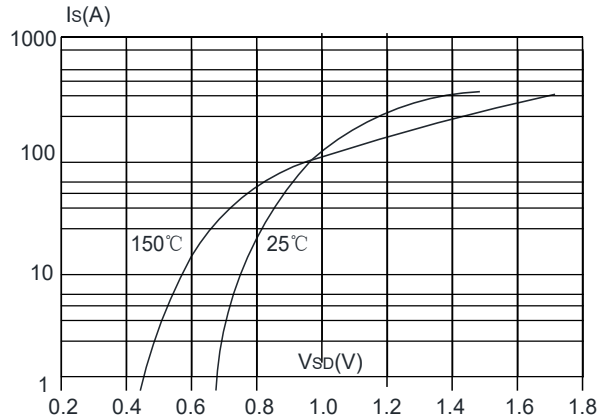

Figure 5: Gate Charge Characteristics

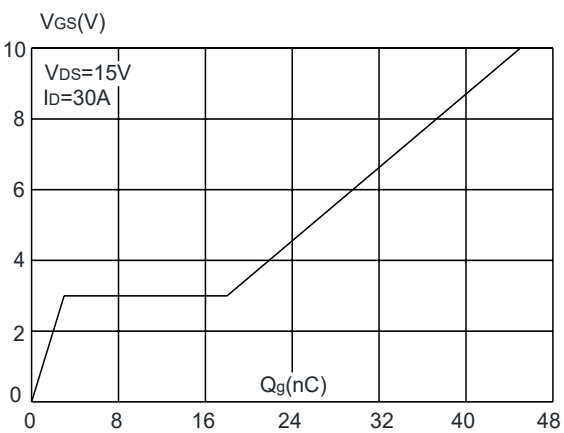
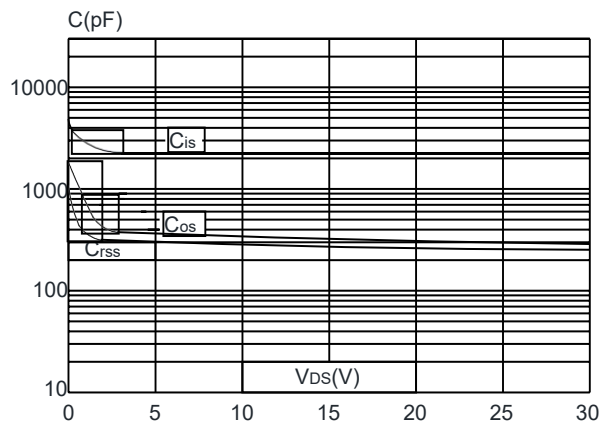

Figure 6: Capacitance Characteristics



RATING AND CHARACTERISTIC CURVES (100N03NF)

Figure 7: Normalized Breakdown Voltage vs. Junction Temperature

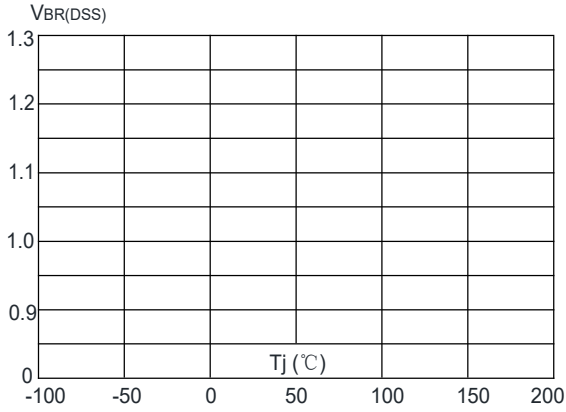

Figure 8: Normalized on Resistance vs. Junction Temperature

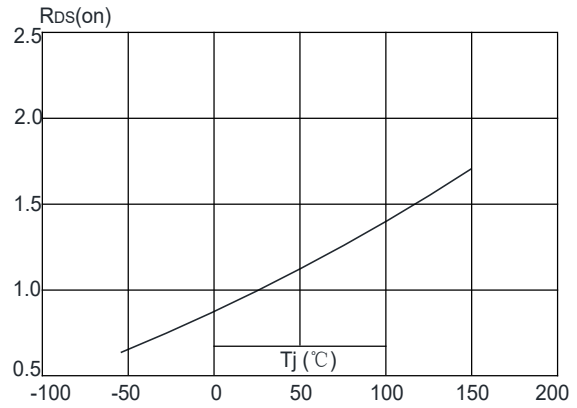

Figure 9: Maximum Safe Operating Area

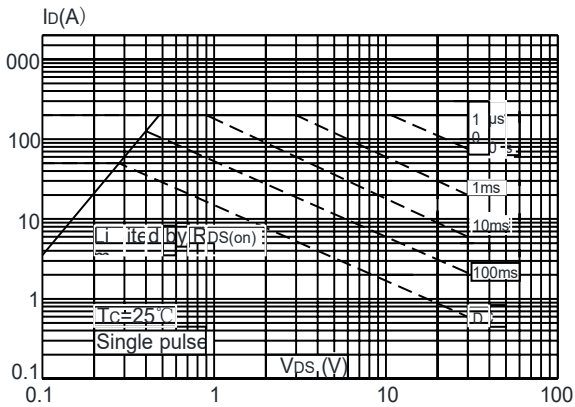

Figure 10: Maximum Continuous Drain Current vs. Case Temperature

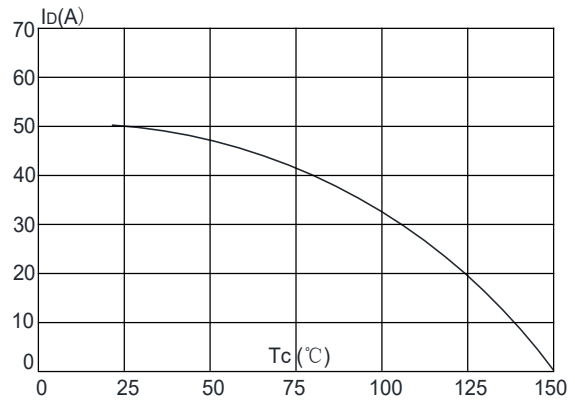
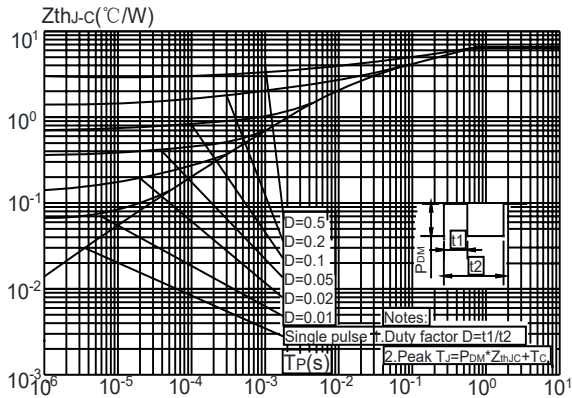

Figure.11: Maximum Effective Transient Thermal Impedance, Junction-to-Case (PDFN3.3*3.3-8L)



Test Circuit

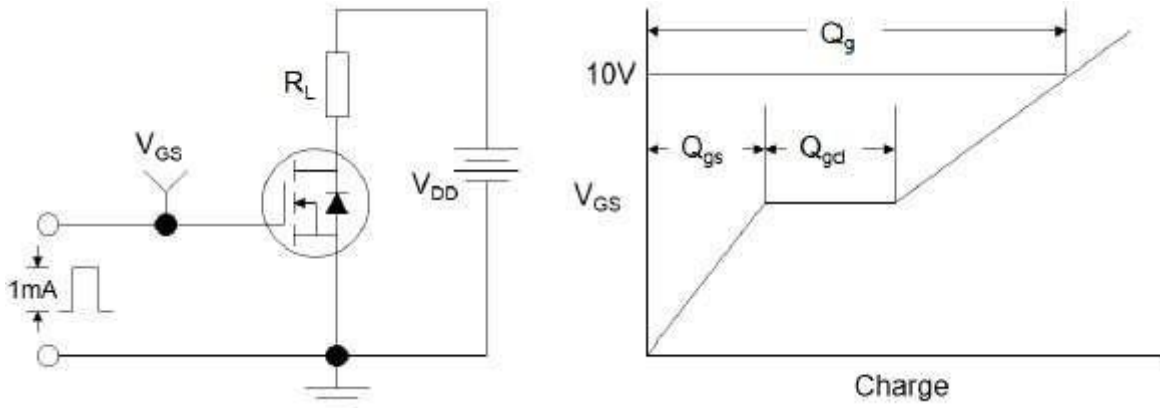

Figure1:Gate Charge Test Circuit & Waveform

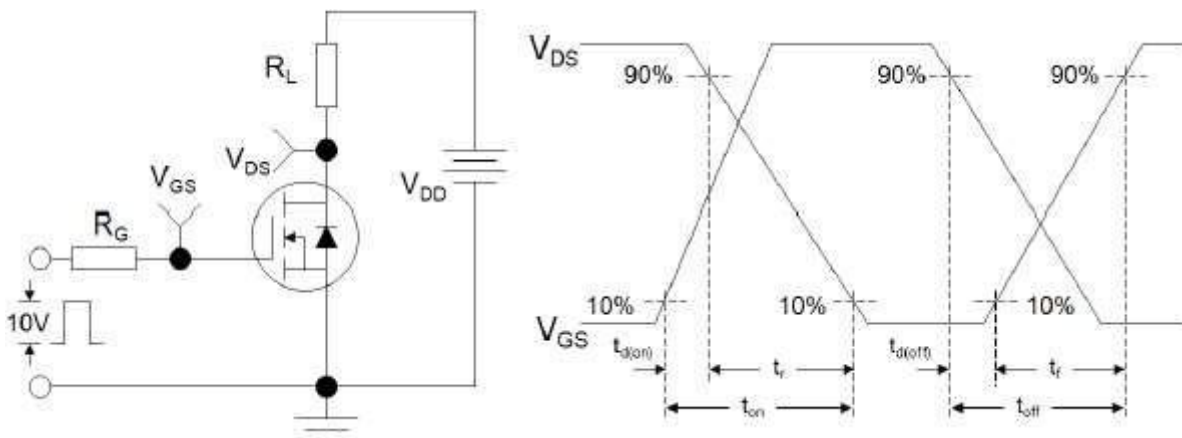

Figure 2: Resistive Switching Test Circuit & Waveforms

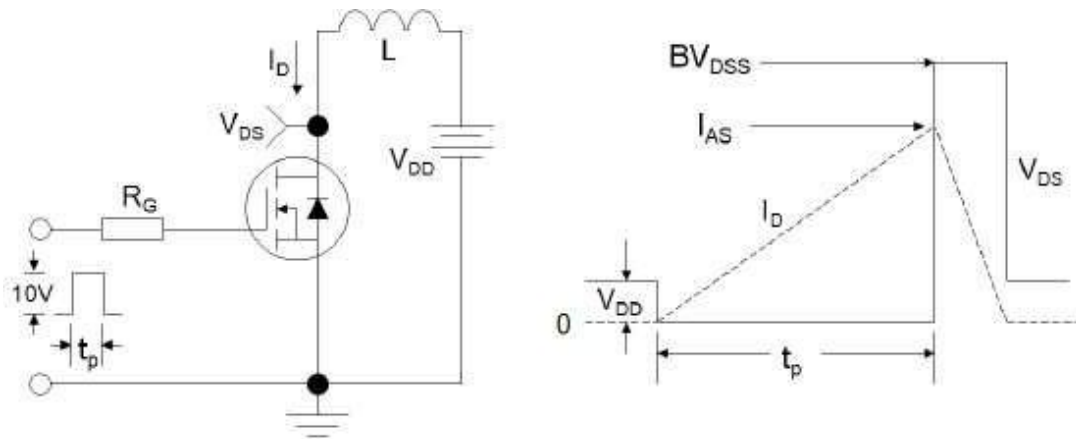

Figure 3:Unclamped Inductive Switching Test Circuit & Waveforms