

Features

- ◇ 45W (8/20μs) Peak Pulse Power
- ◇ Low Capacitance ESD Protection
- ◇ SOT-143 Package
- ◇ RoHS Compliant
- ◇ Matte Tin Lead finish (Pb-Free)
- ◇ Protect Two High Speed Data Lines and Vcc
- ◇ Meet IEC61000-4-2 Level 4:
  - Contact Discharge > 15kV
  - Air Discharge > 20kV

Applications

- ◇ I<sup>2</sup>C Bus Protection
- ◇ ISDN S/T Interface
- ◇ Ethernet 10/100 BaseT
- ◇ Portable Electronics
- ◇ Video Line Protection
- ◇ WAN/LAN Equipment
- ◇ Microcontroller Input Protection
- ◇ USB Power and Data Line Protection
- ◇ T1/E1 Secondary IC Side Protection

Ordering information

Device	Package	Marking
PRTR5V0U2X	SOT-143	WR1

Circuit Diagram

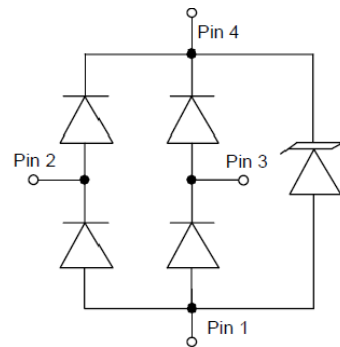

PIN Diagram

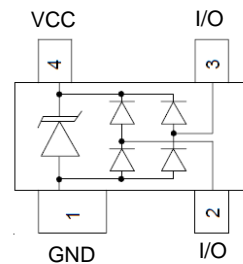

**Absolute Maximum Ratings (T<sub>A</sub>=25°C unless otherwise specified)**

Parameter	Symbol	Value	Unit
Peak Pulse Power (8/20μs, I/O-GND)	Ppk	45	W
Peak Pulse Power (8/20μs, Vcc-GND)	Ppk	60	W
Peak Pulse Current (8/20μs, I/O-GND)	IPP	3	A
Peak Pulse Current (8/20μs, Vcc-GND)	IPP	4	A
ESD per IEC 61000-4-2 (Air)	V <sub>ESD, VDD</sub>	±20	kV
ESD per IEC 61000-4-2 (Contact)	V <sub>ESD, I/O</sub>	±15	kV
Operating Temperature Range	T <sub>J</sub>	-55 to +125	°C
Storage Temperature Range	T <sub>stg</sub>	-55 to +150	°C

# PRTR5V0U2X

## Electrical Characteristics ( $T_A=25^{\circ}\text{C}$ unless otherwise specified)

Parameter	Symbol	Test Condition	Min	Typ	Max	Unit
Reverse Working Voltage	$V_{RWM}$	Pin 5 to GND,I/O-GND			5.0	V
Breakdown Voltage	$V_{BR}$	$I_T = 1\text{mA}(\text{pin 5 to GND,I/O-GND})$	6.0	7.5	8.5	V
Reverse Leakage Current	$I_R$	$V_{RWM} = 5.0\text{V}$			0.5	$\mu\text{A}$
Forward Breakdown Voltage	$V_F$	$I_F = 15\text{mA}, \text{GND to Pin 5/IO}$		0.8	1.0	V
Clamping Voltage	$V_C$	$I_{PP} = 3\text{A} (8 \times 20\mu\text{s pulse, I/O to GND})$		14.0	15.0	V
Clamping Voltage	$V_C$	$I_{PP} = 4\text{A} (8 \times 20\mu\text{s pulse, Pin 5 to GND})$		16.0	18.0	V
Junction Capacitance	$C_J$	$V_{\text{pin5}} = 5\text{V}, I/O=0\text{V},$ $f = 1\text{MHz}, I/O\text{-GND}$		0.6	0.7	pF
Junction Capacitance	$C_J$	$V_{\text{pin5}} = 5\text{V}, I/O=0\text{V},$ $f = 1\text{MHz}, I/O\text{-I/O pins}$		0.3	0.4	pF

## RATING AND CHARACTERISTIC CURVES (PRTR5V0U2X)

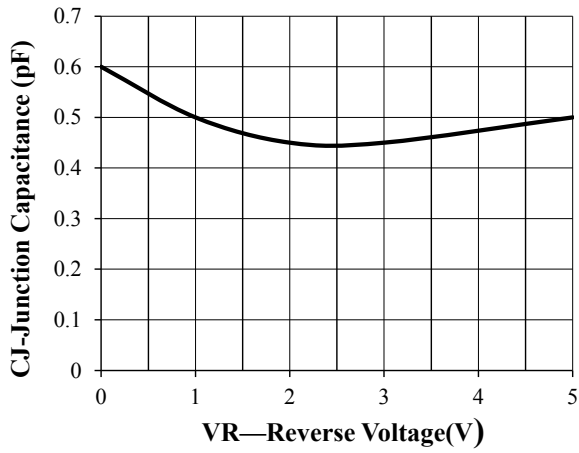

**Junction Capacitance vs. Reverse Voltage**

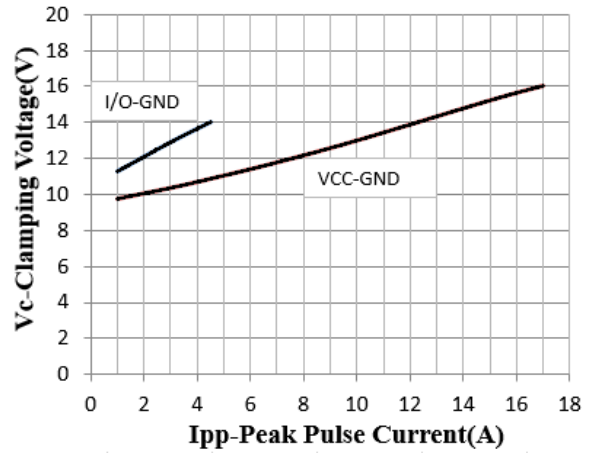

**Clamping Voltage vs. Peak Pulse Current**

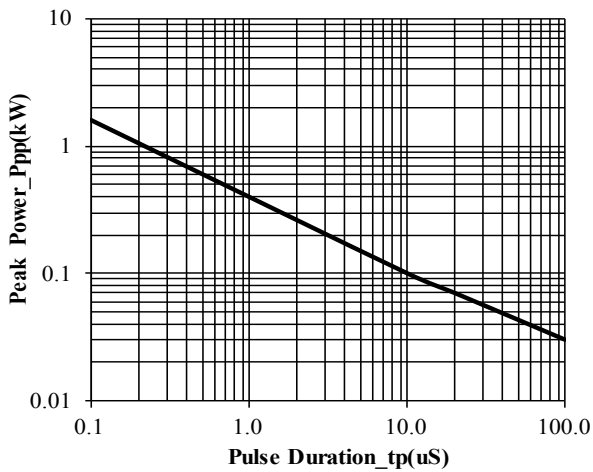

**Peak Pulse Power vs. Pulse Time**

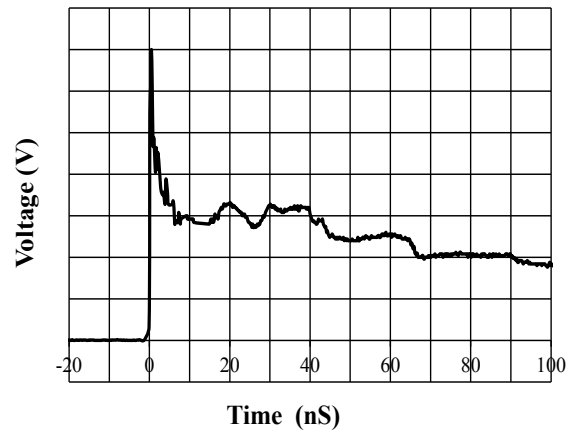

**IEC61000-4-2 Pulse Waveform**

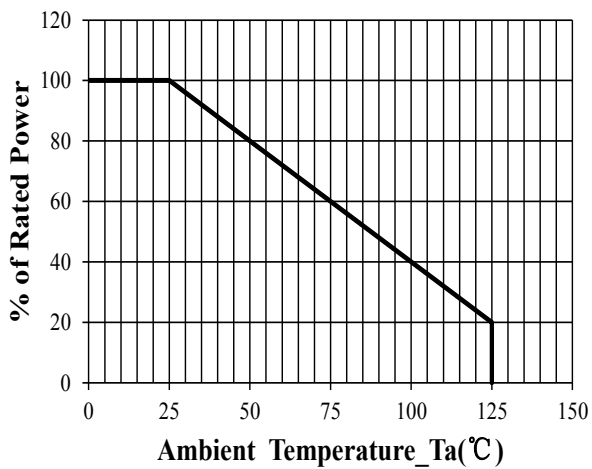

**Power Derating Curve**

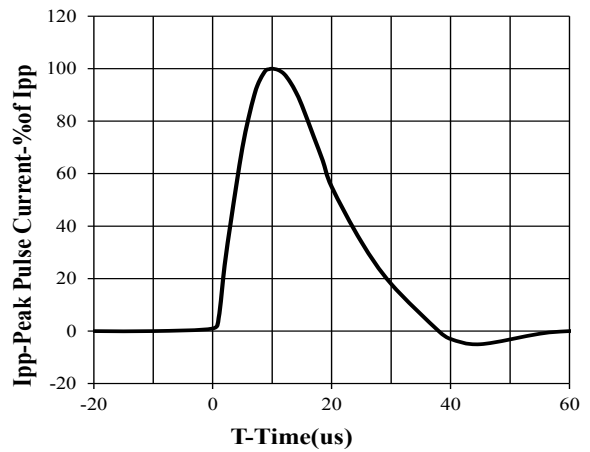

**8 X 20us Pulse Waveform**

# SOT-143 PACKAGE OUTLINE DIMENSIO

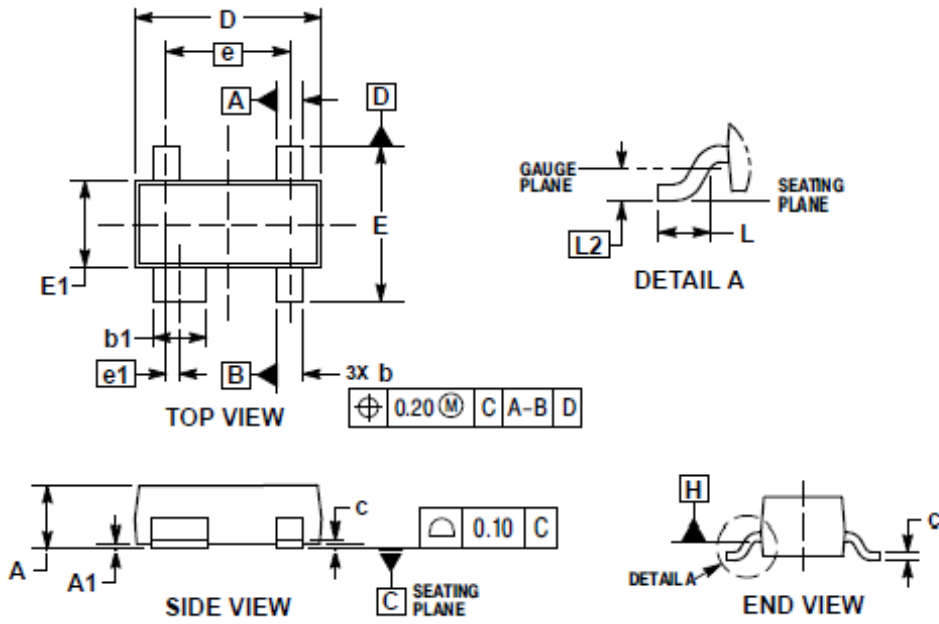

DIM	MILLIMETERS	
	MIN	MAX
A	0.80	1.12
A1	0.01	0.15
b	0.30	0.51
b1	0.75	0.94
c	0.08	0.20
D	2.80	3.05
E	2.10	2.64
E1	1.20	1.40
e	1.92 BSC	
e1	0.20 BSC	
L	0.35	0.70
L2	0.25 BSC	