

PXA15xxSxx

Single Output 15 Watt DC-DC Converters

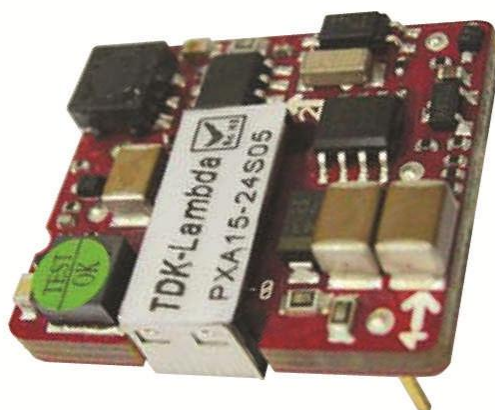

The PXA15 series is approved to UL/CSA/EN/IEC 60950-1.

Table of contents

Absolute Maximum Rating	P2	Remove ON/OFF Control	P16
Output Specification	P2	Test Configurations	P17
Input Specification	P3	Mechanical Data	P18
General Specification	P3	Recommended Pad Layout	P19
Characteristic Curves	P4	Soldering and Reflow Considerations	P20
Thermal Consideration	P12	Clearing and Drying Considerations	P21
Short Circuit Protection	P12	Packaging Information	P22
Output Over Current Protection	P12	Part Number Structure	P23
EMC Consideration	P13	Safety and Installation Instruction	P23
External Trim Adjustment	P15	MTBF and Reliability	P23

ABSOLUTE MAXIMUM RATINGS					
Parameter	Device	Min	Typ	Max	Unit
Input Surge Voltage(100mS max)	24Sxx	-0.3		50	Vdc
	48Sxx	-0.3		100	Vdc
Operating Ambient Temperature	All	-40		85	°C
Storage Temperature	All	-55		125	°C
I/O Isolation Voltage	All	2250			Vdc

OUTPUT SPECIFICATIONS					
Parameter	Device	Min	Typ	Max	Unit
Operating Output Range	xxS3P3	3.267	3.3	3.333	Vdc
	xxS05	4.95	5	5.05	Vdc
	xxS12	11.88	12	12.12	Vdc
	xxS15	14.85	15	15.15	Vdc
Voltage Adjustability (Note 1)	All	-10		+10	%
Output Regulation	All			0.2	%
				Line (LL to HL at Full Load)	0.2
Output Ripple & Noise (Note 2) (Measured with a 1uF M/C and a 10uF T/C at 20MHz bandwidth)	S3P3,S05 S12,S15			75	mVp-p
				100	
Temperature Coefficient	All	-0.02		+0.02	%/°C
Output Voltage Overshoot	All			3	%
Transient Response Recovery Time (50% to 75% to 50% load change, $\Delta I_o/\Delta t=0.1A/us$)	All		300		μs
Output Current	xxS3P3	0		3.5	A
	xxS05	0		3.0	A
	xxS12	0		1.25	A
	xxS15	0		1.0	A
Output Over Voltage Protection (Control voltage clamp)	xxS3P3	3.7		5.4	Vdc
	xxS05	5.6		7.0	Vdc
	xxS12	13.5		19.6	Vdc
	xxS15	16.8		20.5	Vdc
Output Over Current Protection	xxS3P3	3.85	4.375	4.9	A
	xxS05	3.3	3.75	4.2	A
	xxS12	1.375	1.56	1.75	A
	xxS15	1.1	1.25	1.4	A
Output Capacitor Load	xxS3P3			1000	μF
	xxS05			1000	μF
	xxS12			330	μF
	xxS15			220	μF

INPUT SPECIFICATIONS					
Parameter	Device	Min	Typ	Max	Unit
Operating Input Voltage	24Sxx	18	24	36	Vdc
	48Sxx	36	48	75	Vdc
Under Voltage Lockout Turn-on Threshold	24Sxx		17		Vdc
	48Sxx		33		Vdc
Under Voltage Lockout Turn-off Threshold	24Sxx		14.5		Vdc
	48Sxx		30.5		Vdc
Input reflected ripple current (Note 2)	All		30		mAp-p
Start Up Time					
Power Up	All			30	ms
Remote ON/OFF	All			30	ms
(Test at $V_{in} = V_{in(nom)}$ and constant resistive load)					
Remote ON/OFF (Note 3)					
Negative Logic	DC-DC ON(Short)	All	-0.7	1.2	Vdc
	DC-DC OFF(Open)	All	3	15	Vdc
Positive Logic	DC-DC ON(Open)	All	3	15	Vdc
	DC-DC OFF(Short)	All	-0.7	1.2	Vdc

GENERAL SPECIFICATIONS					
Parameter	Device	Min	Typ	Max	Unit
Efficiency (Note 2) (Test at $V_{in} = V_{in(nom)}$ and full load)	24S3P3		86		%
	24S05		87		%
	24S12		87		%
	24S15		88		%
	48S3P3		85		%
	48S05		87		%
	48S12		87		%
	48S15		88		%
Isolation resistance	All	10			M Ω
Isolation Capacitance	All		1000		pF
Switching Frequency (Test at $V_{in} = V_{in(nom)}$ and full load)	S3P3,S05		270		KHz
	S12,S15		470		KHz
Transient Response Recovery Time (50% to 75% to 50% load change, $\Delta I_o / \Delta t = 0.1A/\mu s$)	All		300		μs
Weight	All		10.5		g
MTBF (Note 4)	All		2.2×10^6		hours

Note 1: Please see the external trim adjustment.

Note 2: Please see the testing configurations part.

Note 3: Please see the remote ON/OFF control part.

Note 4: Please see the MTBF and reliability part.

PXA15-24S3P3 Characteristic Curves

All test conditions are at 25 °C. The figures are identical for either option suffix part numbers:

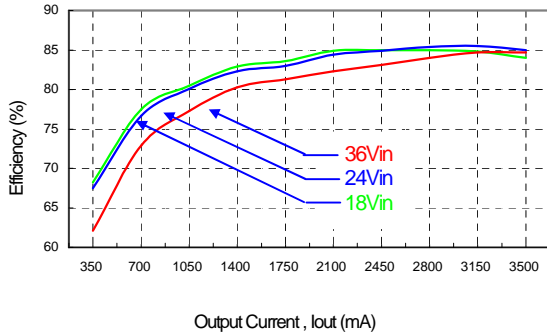

Efficiency versus Output Current

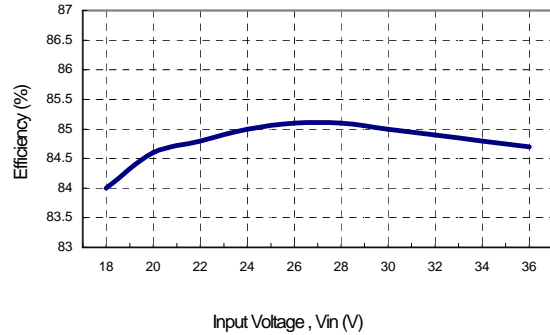

Efficiency versus Input Voltage. Io=Full Load

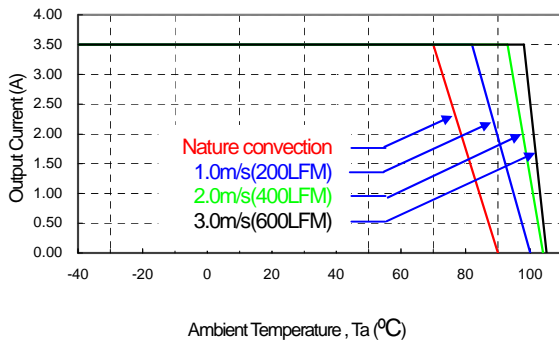

Derating Output Current versus Ambient Temperature and Airflow

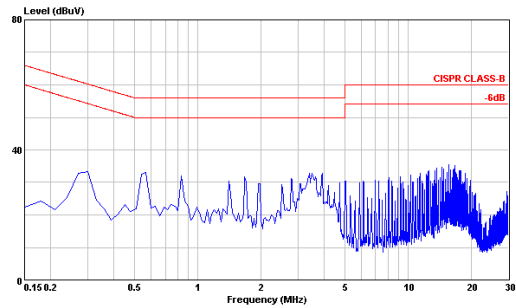

**Conducted Emission of EN55022 Class B
Vin=Vin,nom, Io=Full Load**

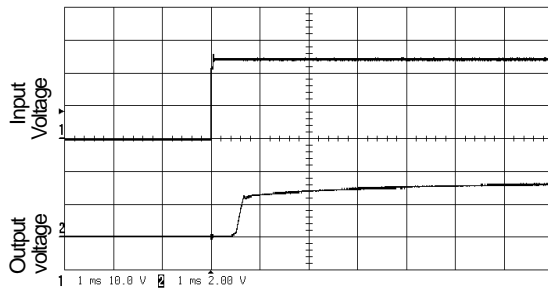

Typical Input Start-Up and Output Rise Characteristic

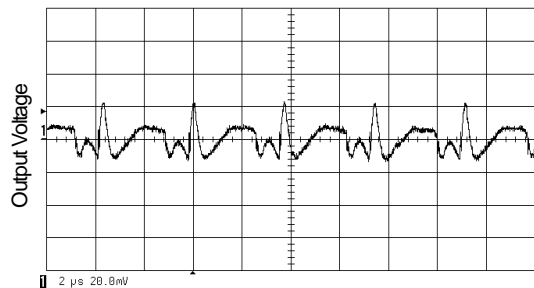

**Typical Output Ripple and Noise.
Vin=Vin,nom, Io=Full Load**

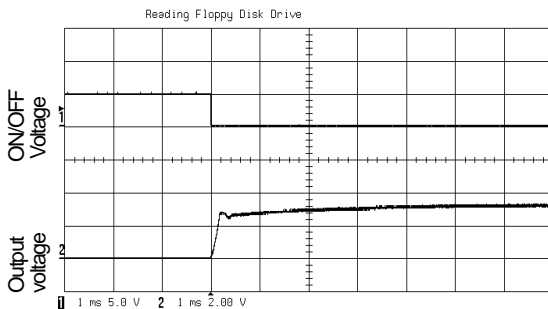

Using ON/OFF Voltage Start-Up and Output Rise Characteristic

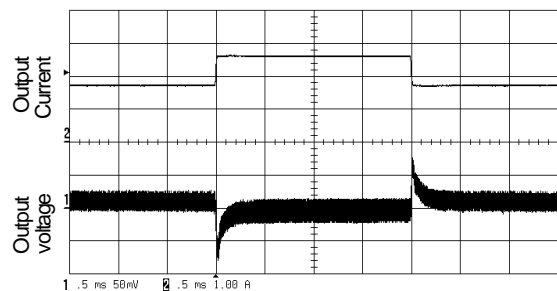

Transient Response to Dynamic Load Change from 75% to 50% to 75% of Full Load

PXA15-24S05 Characteristic Curves

All test conditions are at 25 °C. The figures are identical for either option suffix part numbers:

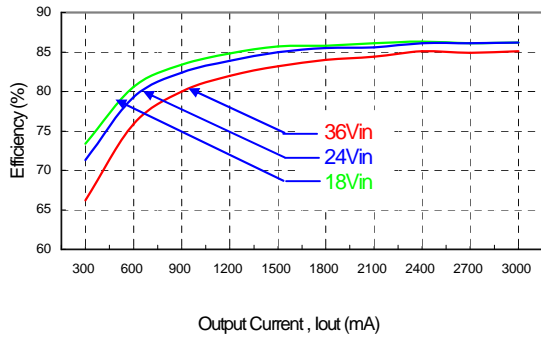

Efficiency versus Output Current

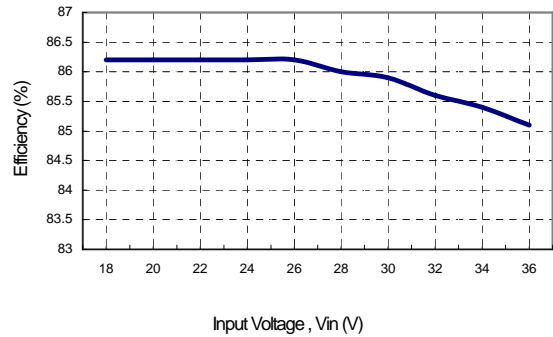

Efficiency versus Input Voltage. Io=Full Load

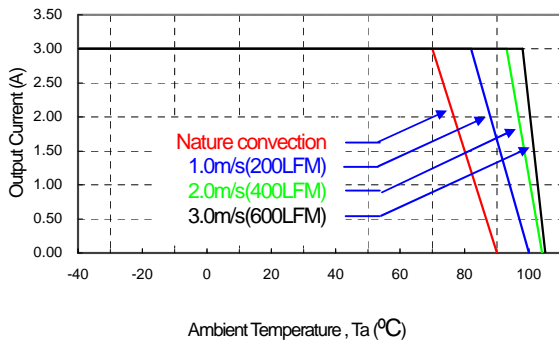

Derating Output Current versus Ambient Temperature and Airflow

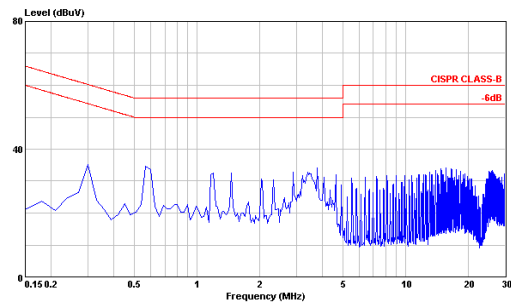

**Conducted Emission of EN55022 Class B
Vin=Vin,nom, Io=Full Load**

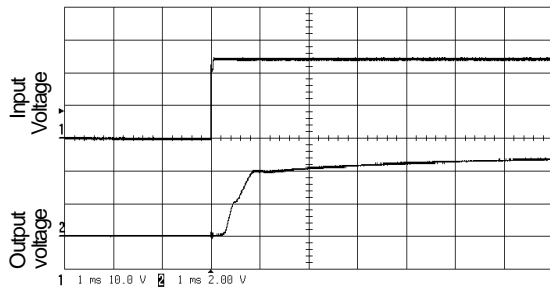

Typical Input Start-Up and Output Rise

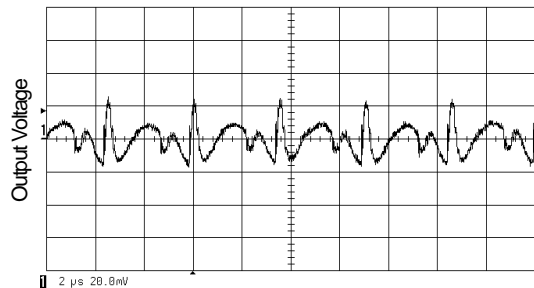

**Typical Output Ripple and Noise.
Vin=Vin,nom, Io=Full Load**

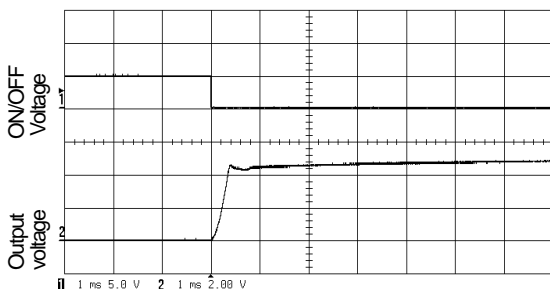

Using ON/OFF Voltage Start-Up and Output Rise

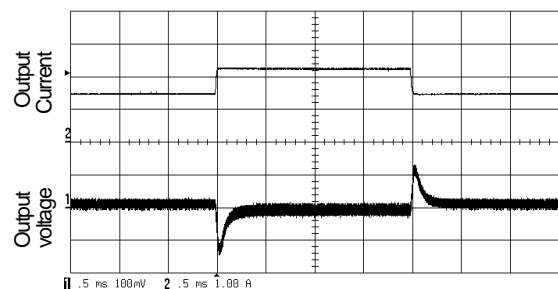

Transient Response to Dynamic Load Change from 75% to 50% to 75% of Full Load

PXA15-24S12 Characteristic Curves

All test conditions are at 25 °C. The figures are identical for either option suffix part numbers:

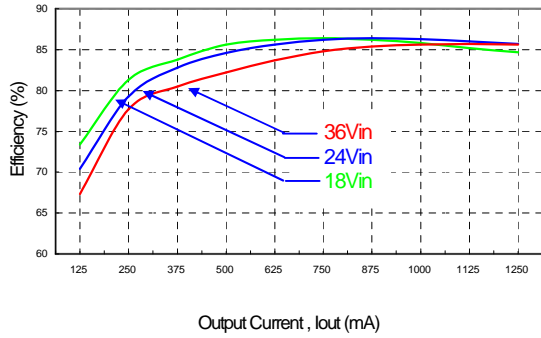

Efficiency versus Output Current

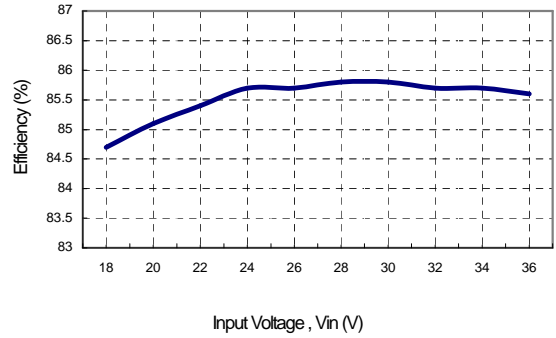

Efficiency versus Input Voltage. Io=Full Load

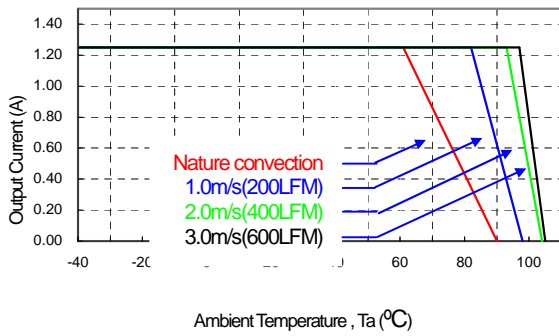

Derating Output Current versus Ambient Temperature and Airflow

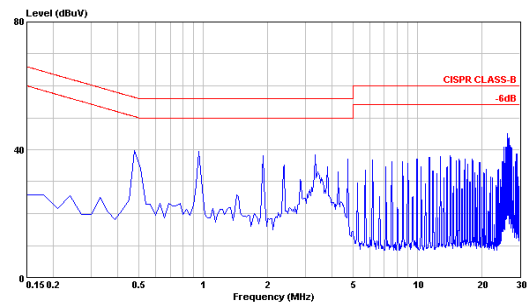

**Conducted Emission of EN55022 Class B
 Vin=Vin,nom, Io=Full Load**

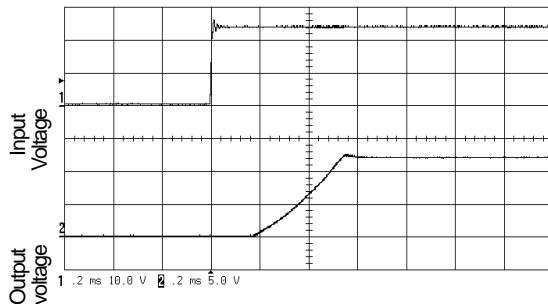

Typical Input Start-Up and Output Rise

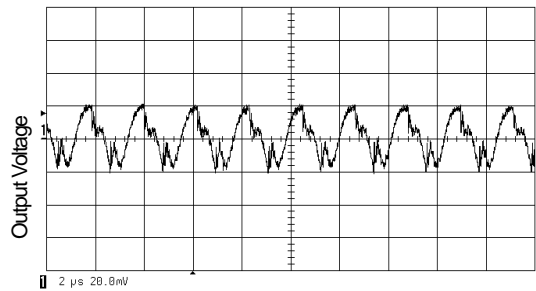

**Typical Output Ripple and Noise.
 Vin=Vin,nom, Io=Full Load**

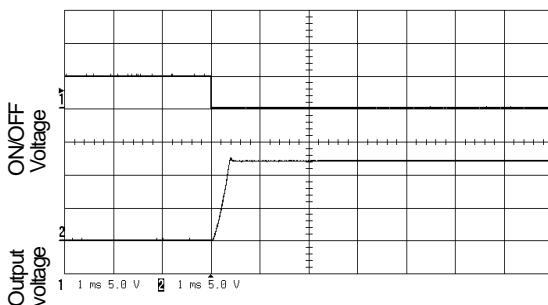

Using ON/OFF Voltage Start-Up and Output Rise

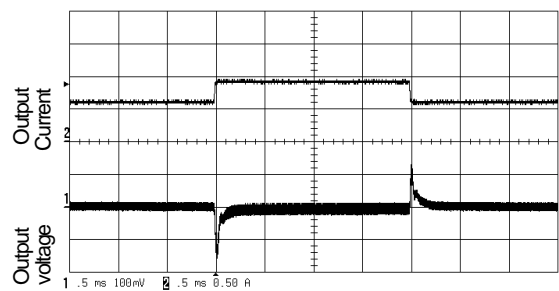

**Transient Response to Dynamic Load Change from
 75% to 50% to 75% of Full Load**

PXA15-24S15 Characteristic Curves

All test conditions are at 25 °C. The figures are identical for either option suffix part numbers:

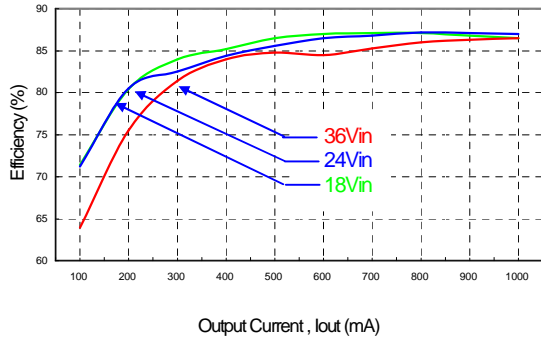

Efficiency versus Output Current

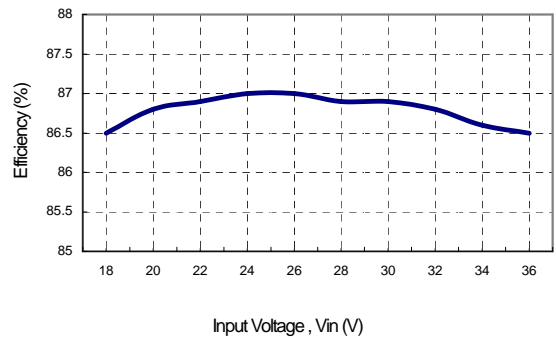

Efficiency versus Input Voltage. Io=Full Load

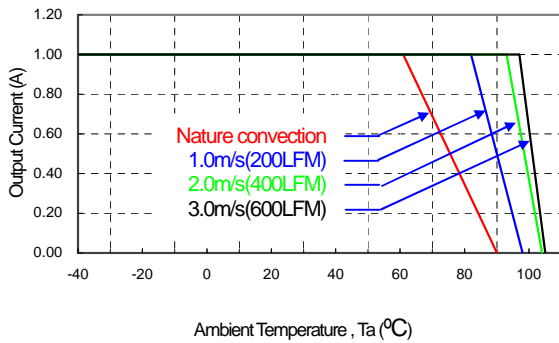

Derating Output Current versus Ambient Temperature and Airflow

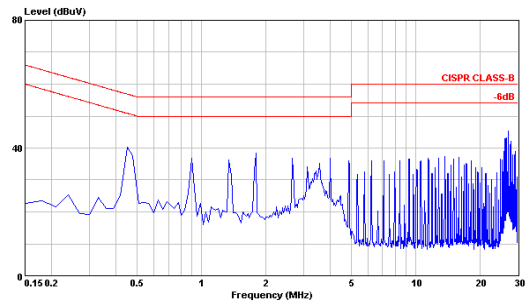

**Conducted Emission of EN55022 Class B
Vin=Vin,nom, Io=Full Load**

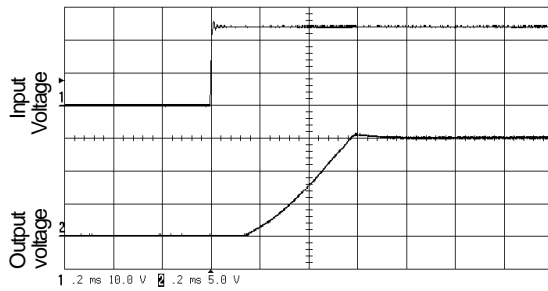

Typical Input Start-Up and Output Rise

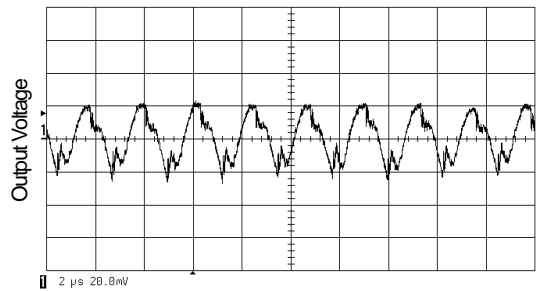

**Typical Output Ripple and Noise.
Vin=Vin,nom, Io=Full Load**

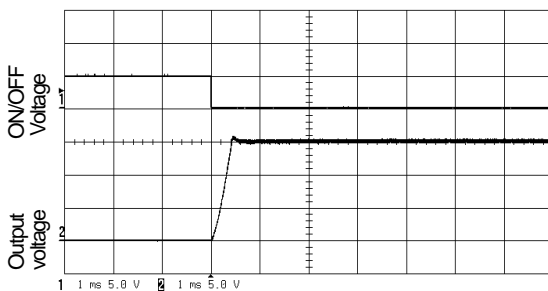

Using ON/OFF Voltage Start-Up and Output Rise C

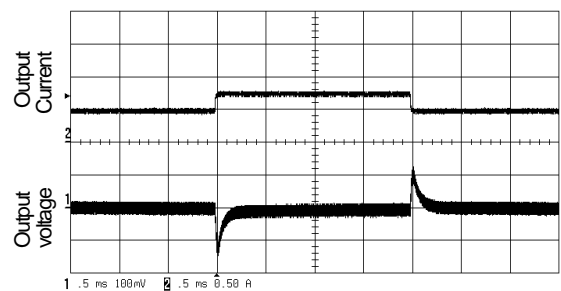

**Transient Response to Dynamic Load Change from
75% to 50% to 75% of Full Load**

PXA15-48S3P3 Characteristic Curves

All test conditions are at 25 °C. The figures are identical for either option suffix part numbers:

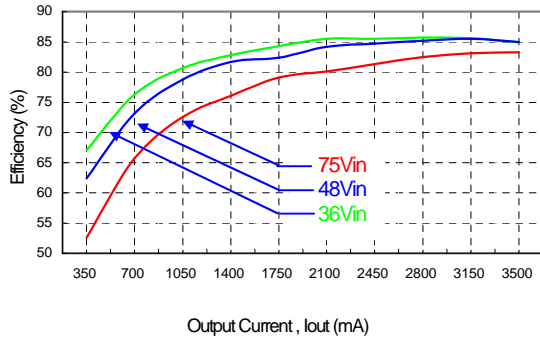

Efficiency versus Output Current

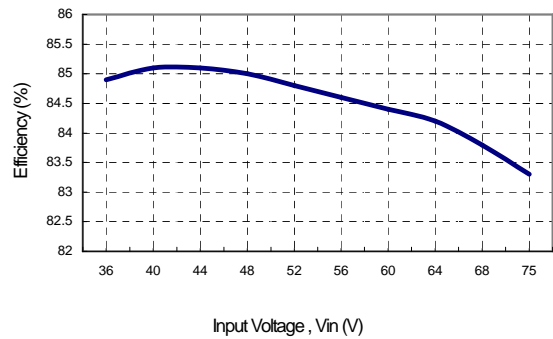

Efficiency versus Input Voltage. I_o=Full Load

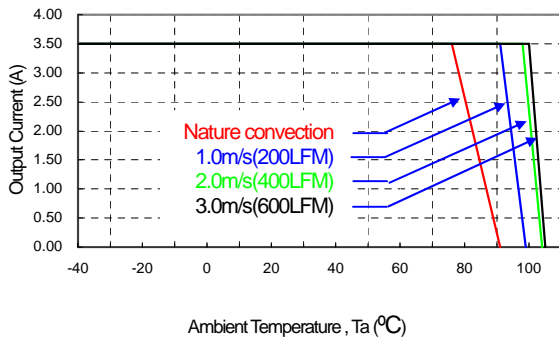

Derating Output Current versus Ambient Temperature and Airflow

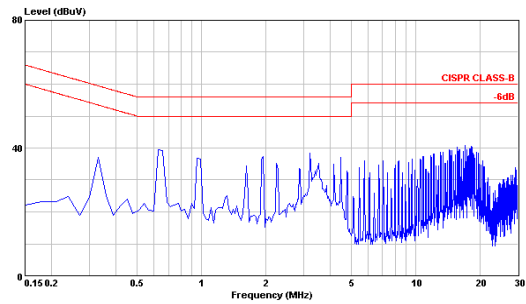

**Conducted Emission of EN55022 Class B
V_{in}=V_{in,nom}, I_o=Full Load**

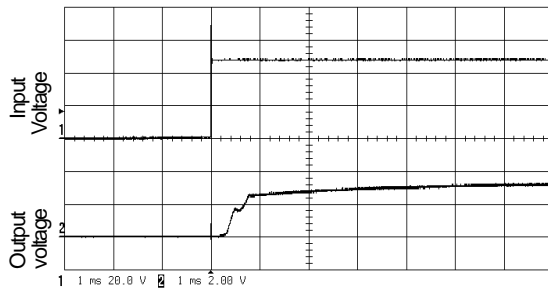

Typical Input Start-Up and Output Rise

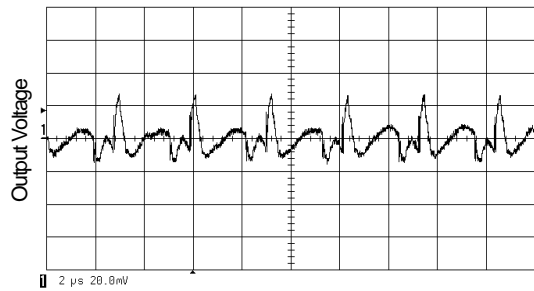

**Typical Output Ripple and Noise.
V_{in}=V_{in,nom}, I_o=Full Load**

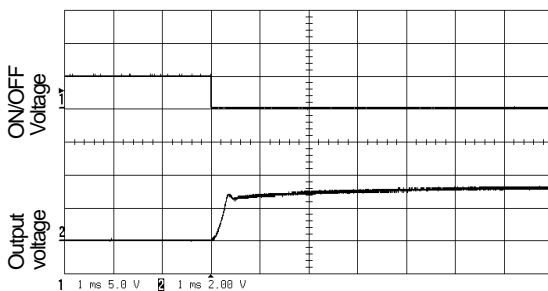

Using ON/OFF Voltage Start-Up and Output Rise Ch

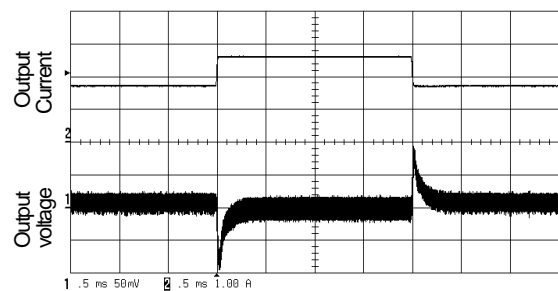

Transient Response to Dynamic Load Change from 75% to 50% to 75% of Full Load

PXA15-48S05 Characteristic Curves

All test conditions are at 25 °C. The figures are identical for either option suffix part numbers:

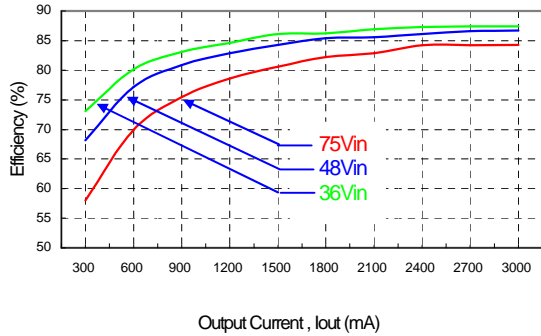

Efficiency versus Output Current

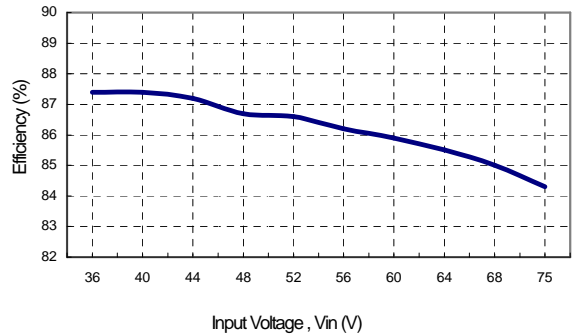

Efficiency versus Input Voltage. I_o=Full Load

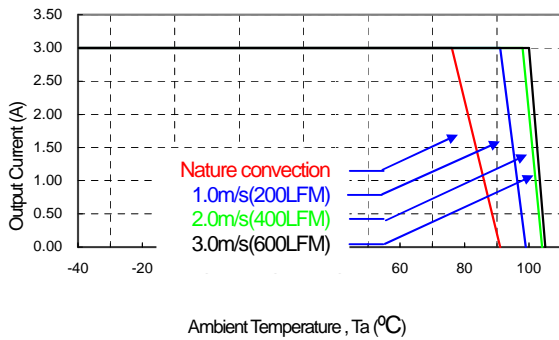

Derating Output Current versus Ambient Temperature and Airflow

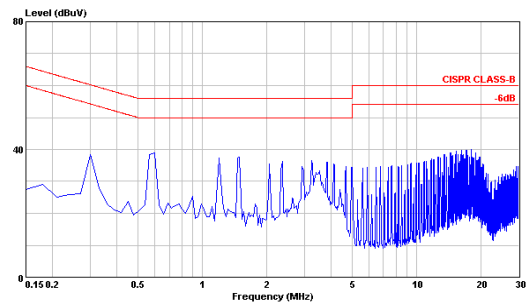

**Conducted Emission of EN55022 Class B
V_{in}=V_{in,nom}, I_o=Full Load**

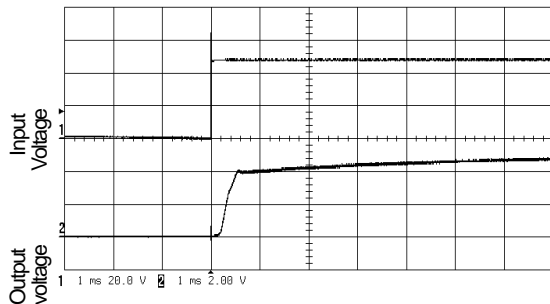

Typical Input Start-Up and Output Rise Characteristic

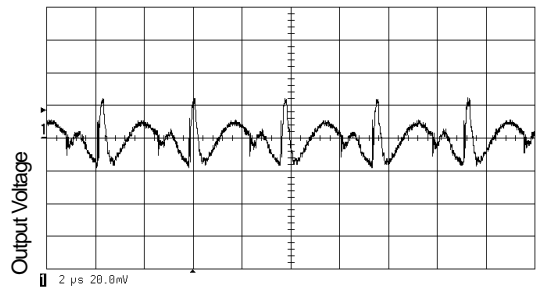

**Typical Output Ripple and Noise.
V_{in}=V_{in,nom}, I_o=Full Load**

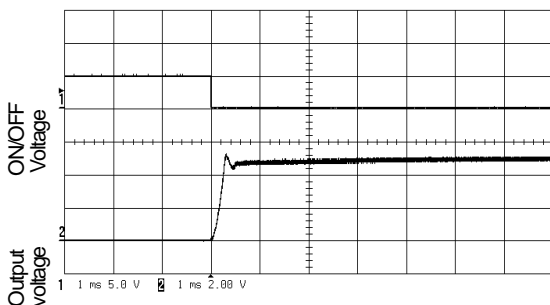

Using ON/OFF Voltage Start-Up and Output Rise

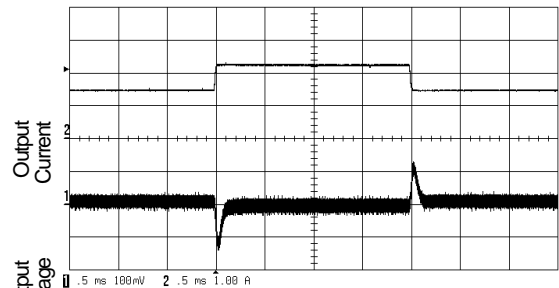

Transient Response to Dynamic Load Change from 75% to 50% to 75% of Full Load

PXA15-48S12 Characteristic Curves

All test conditions are at 25 °C. The figures are identical for either option suffix part numbers:

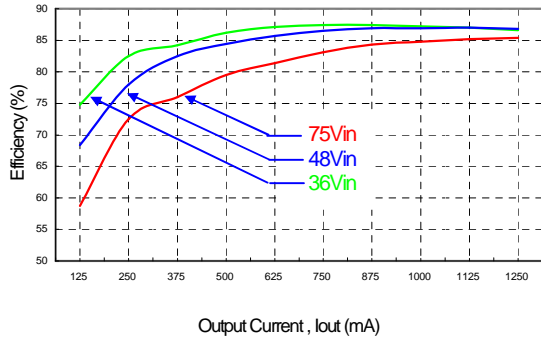

Efficiency versus Output Current

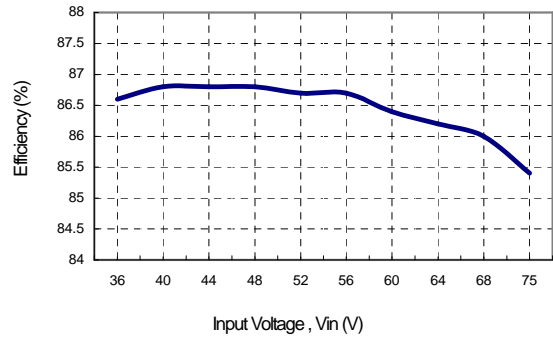

Efficiency versus Input Voltage. I_o=Full Load

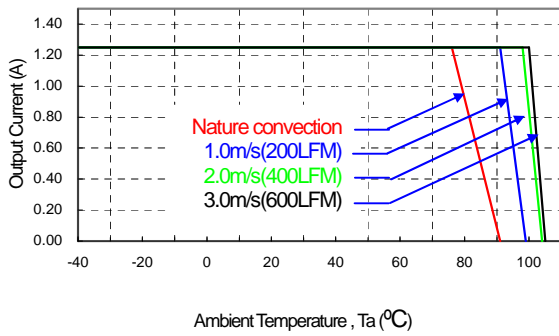

Derating Output Current versus Ambient Temperature and Airflow

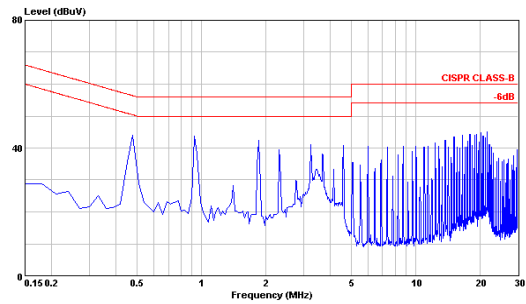

**Conducted Emission of EN55022 Class B
V_{in}=V_{in,nom}, I_o=Full Load**

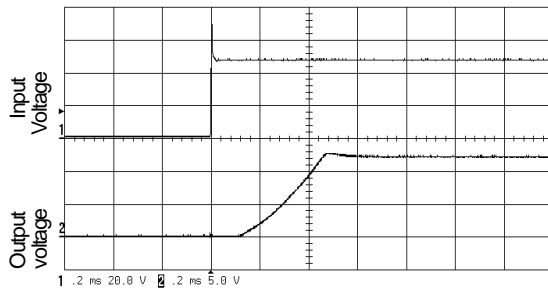

Typical Input Start-Up and Output Rise

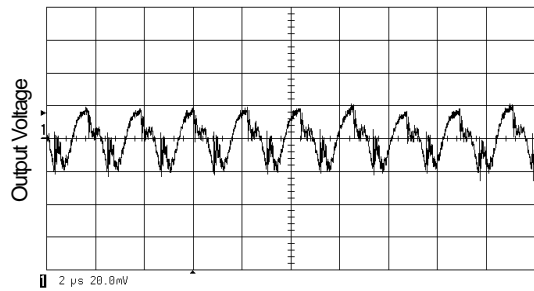

**Typical Output Ripple and Noise.
V_{in}=V_{in,nom}, I_o=Full Load**

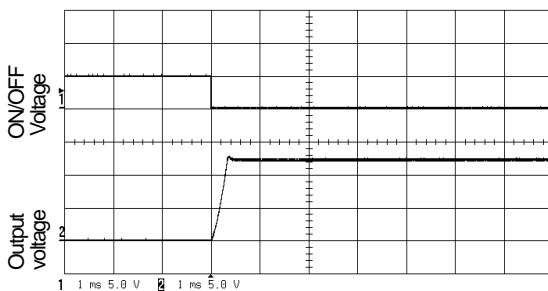

Using ON/OFF Voltage Start-Up and Output Rise

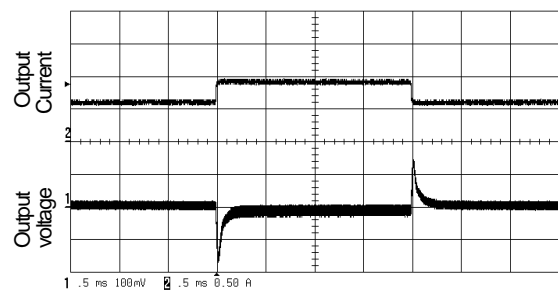

Transient Response to Dynamic Load Change from 75% to 50% to 75% of Full Load

PXA15-48S15 Characteristic Curves

All test conditions are at 25 °C. The figures are identical for either option suffix part numbers:

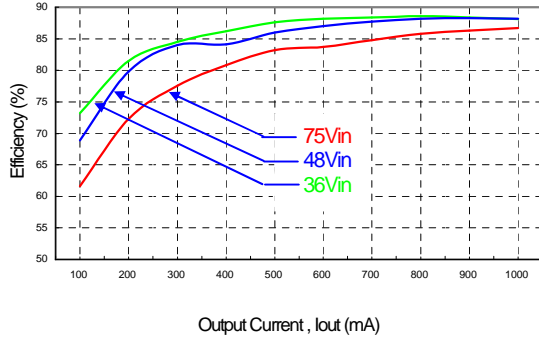

Efficiency versus Output Current

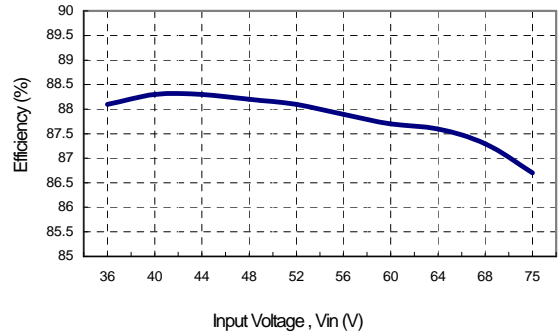

Efficiency versus Input Voltage. Io=Full Load

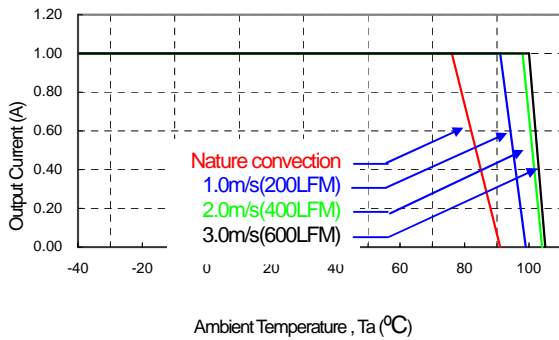

Derating Output Current versus Ambient Temperature and Airflow

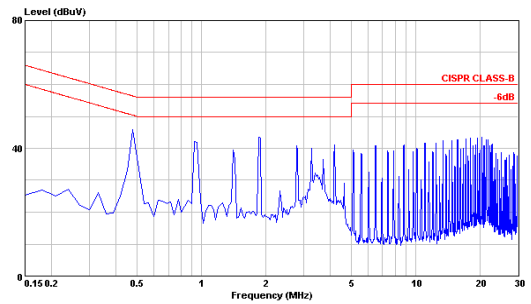

Conducted Emission of EN55022 Class B
Vin=Vin,nom, Io=Full Load

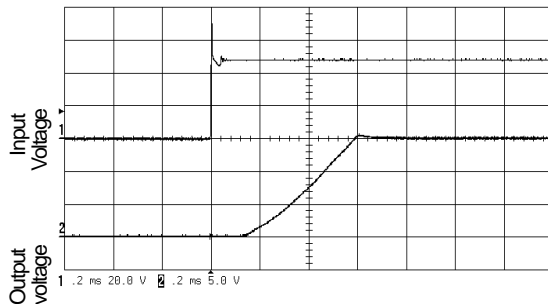

Typical Input Start-Up and Output Rise Characteristic

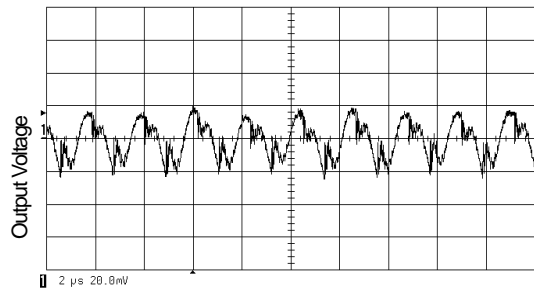

Typical Output Ripple and Noise.
Vin=Vin,nom, Io=Full Load

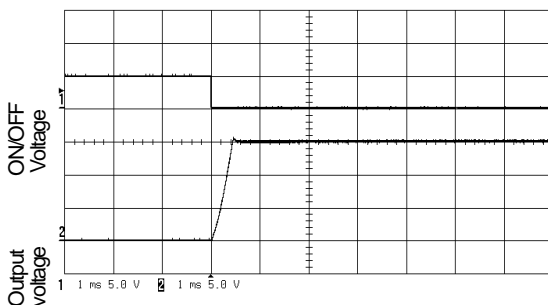

Using ON/OFF Voltage Start-Up and Output Rise

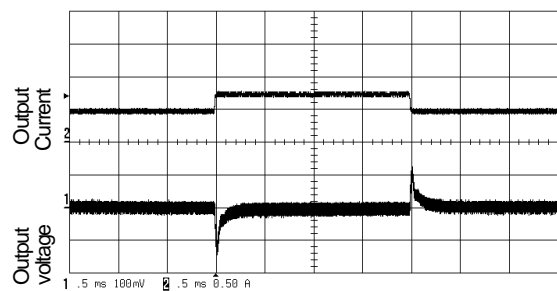

Transient Response to Dynamic Load Change from 75% to 50% to 75% of Full Load

Thermal Consideration

The power module operates in a variety of thermal environments; however, sufficient cooling should be provided to help ensure reliable operation of the unit. Heat is removed by conduction, convection, and radiation to the surrounding environment. Proper cooling can be verified by measuring the point as the figure below. The temperature at this location should not exceed 120 °C. When Operating, adequate cooling must be provided to maintain the test point temperature at or below 120 °C. Although the maximum point temperature of the power modules is 120 °C, maintaining a lower operating temperature will increase the reliability of this device.

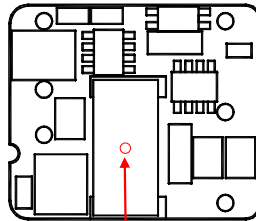

Temperature Measure Point

Short Circuit Protection

Continuous, hiccup and auto-recovery mode.

During a short circuit condition the converter will shut down. The average current during this condition will be very low and damage to this device should not occur.

Output over current protection

When excessive output currents occur in the system, circuit protection is required on all power supplies. Normally, overload current is maintained at approximately 110~140 percent of rated current for PXA15 series.

Hiccup-mode is a method of operation in a power supply whose purpose is to protect the power supply from being damaged during an over-current fault condition. It also enables the power supply to restart when the fault is removed. There are other ways of protecting the power supply when it is over-loaded, such as the maximum current limiting or current foldback methods.

One of the problems resulting from over current is that excessive heat may be generated in power devices; especially MOSFET and Schottky diodes and the temperature of those devices may exceed their specified limits. A protection mechanism has to be used to prevent those power devices from being damaged.

The operation of hiccup is as follows. When the current sense circuit sees an over-current event, the controller shuts off the power supply for a given time and then tries to start up the power supply again. If the over-load condition has been removed, the power supply will start up and operate normally; otherwise, the controller will see another over-current event and shut off the power supply again, repeating the previous cycle. Hiccup operation has none of the drawbacks of the other two protection methods, although its circuit is more complicated because it requires a timing circuit. The excess heat due to overload lasts for only a short duration in the hiccup cycle, hence the junction temperature of the power devices is much lower.

The hiccup operation can be done in various ways. For example, one can start hiccup operation any time an over-current event is detected; or prohibit hiccup during a designated start-up interval (usually a few milliseconds). The reason for the latter operation is that during start-up, the power supply needs to provide extra current to charge up the output capacitor. Thus the current demand during start-up is usually larger than during normal operation and it is easier for an over-current event to occur. During start-up, if the power supply starts to hiccup when there is an over-current, it might never start up successfully. Hiccup mode protection will give the best protection for a power supply against over current situations, since it will limit the average current to the load at a low level, so reducing power dissipation and case temperature in the power devices.

EMC considerations

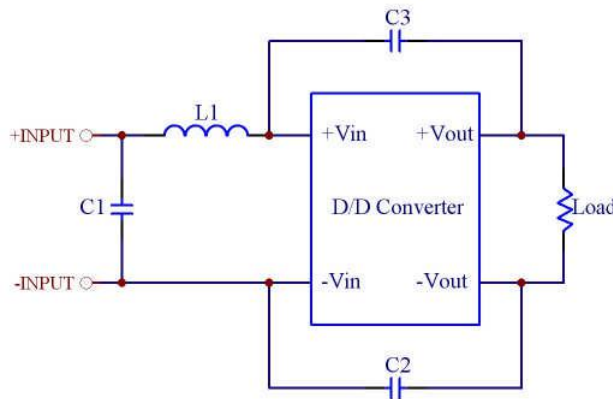

Suggested schematic for EN55022 conducted emission Class A limits

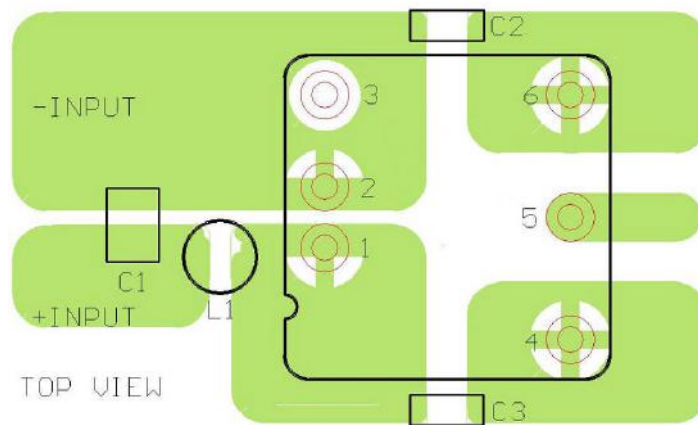

Recommended layout with input filter

To meet conducted emissions EN55022 CLASS A, the following components are needed:

PXA15-24Sxx

Component	Value	Voltage	Reference
L1	10 μ H	---	1.4A 0.1 Ω 0504 SMD Inductor
C1	6.8 μ F	50V	1812 MLCC
C2 & C3	470pF	3KV	1808 MLCC

PXA15-48Sxx

Component	Value	Voltage	Reference
L1	18 μ H	---	1.2A 0.15 Ω 0504 SMD Inductor
C1	2.2 μ F	100V	1812 MLCC
C2 & C3	470pF	3KV	1808 MLCC

EMC considerations(Continued)

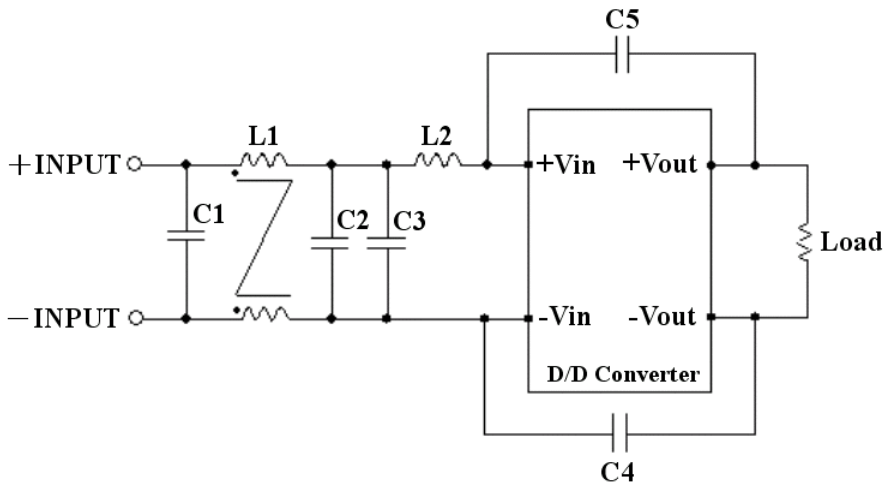

Suggested Schematic for EN55022 Conducted Emission Class B Limits

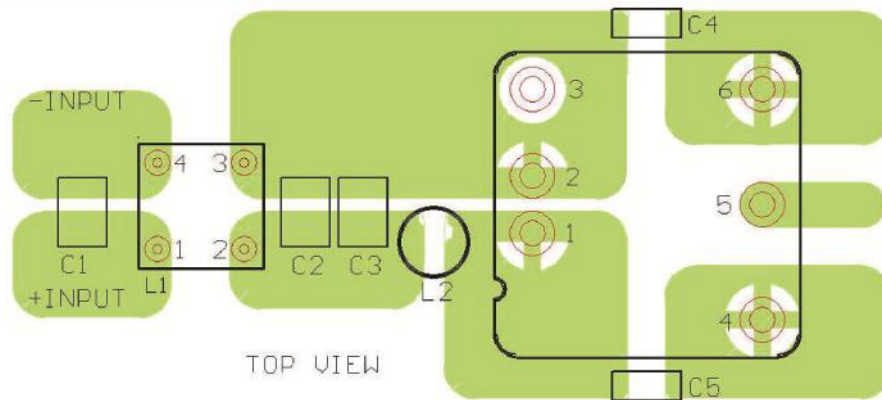

Recommended Layout With Input Filter

To meet conducted emissions EN55022 CLASS B, the following components are needed:

PXA15-24Sxx

Component	Value	Voltage	Reference
C1 & C2	6.8µF	50V	1812 MLCC
C3	6.8µF	50V	1812 MLCC
C4 & C5	470pF	3KV	1808 MLCC
L1	145µH	---	Common Choke
L2	10µH	---	1.44A 0.1Ω 0504 SMD Inductor

PXA15-48Sxx

Component	Value	Voltage	Reference
C1 & C2	2.2µF	100V	1812 MLCC
C3	2.2µF	100V	1812 MLCC
C4 & C5	470pF	3KV	1808 MLCC
L1	145µH	---	Common Choke
L2	18µH	---	1.2A 0.15Ω 0504 SMD Inductor

External trim adjustment

Output voltage set point adjustment allows the user to increase or decrease the output voltage set point of a module. This is accomplished by connecting an external resistor between the TRIM pin and either the +Vout or -Vout pins. With an external resistor between the TRIM and +Vout pin, the output voltage set point decreases. With an external resistor between the TRIM and -Vout pin, the output voltage set point increases.

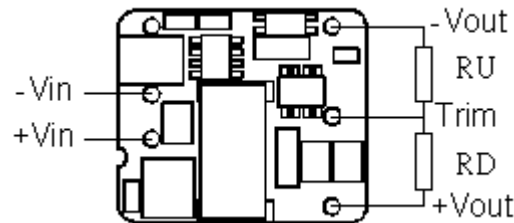

● **Trim up equation**

$$RU = \left[\frac{G \times L}{(Vo,up - L - K)} - H \right] \Omega$$

● **Trim down equation**

$$RD = \left[\frac{(Vo,down - L) \times G}{(Vo - Vo,down)} - H \right] \Omega$$

● **Trim constants**

Module	G	H	K	L
PXA15-xxS15	10000	5110	12.5	2.5
PXA15-xxS12	10000	5110	9.5	2.5
PXA15-xxS05	5110	2050	2.5	2.5
PXA15-xxS3P3	5110	2050	0.8	2.5

● **RU & RD List (Unit : KΩ)**

RU trim up

%of Vo	+1%	+2%	+3%	+4%	+5%	+6%	+7%	+8%	+9%	+10%
xxS15	161.557	78.223	50.446	36.557	28.223	22.668	18.700	15.723	13.409	11.557
xxS12	203.223	99.057	64.334	46.973	36.557	29.612	24.652	20.932	18.038	15.723
xxS05	253.450	125.700	83.117	61.825	49.050	40.533	34.450	29.888	26.339	23.500
xxS3P3	385.071	191.511	126.990	94.730	75.374	62.470	53.253	46.340	40.963	36.662

RD trim down

%of Vo	-1%	-2%	-3%	-4%	-5%	-6%	-7%	-8%	-9%	-10%
xxS15	818.223	401.557	262.668	193.223	151.557	123.779	103.938	89.057	77.483	68.223
xxS12	776.557	380.723	248.779	182.807	143.223	116.834	97.985	83.848	72.853	64.057
xxS05	248.340	120.590	78.007	56.715	43.940	35.423	29.340	24.778	21.229	18.390
xxS3P3	116.719	54.779	34.133	23.810	17.616	13.486	10.537	8.325	6.604	5.228

Remote ON/OFF Control

The Remote ON/OFF Pin is used to turn the DC/DC power module on and off. The user must connect a switch between the on/off pin and the Vi (-) pin. The switch can be open collector transistor, FET, or Photo-Coupler. The switch must be capable of sinking up to 1 mA at low logic level voltage. When using a high logic level, the maximum signal voltage is 15V and the maximum allowable leakage current of the switch is 50 uA.

Remote ON/OFF Implementation Circuits

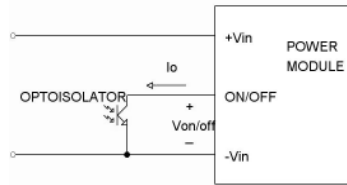

Isolated-Closure Remote ON/OFF

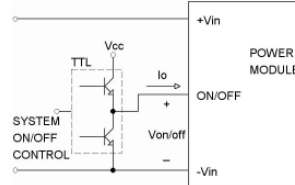

Level Control Using TTL Output

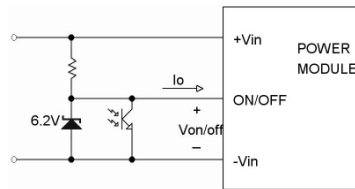

Level Control Using Line Voltage

There are two remote control options available, positive logic and negative logic.

a. Positive logic - The DC/DC module is turned on when the ON/OFF pin is at a high logic level. A low logic signal is needed to turn off the device.

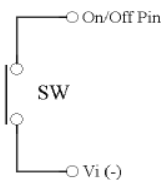

When PXA15 module is turned off at
Low logic level

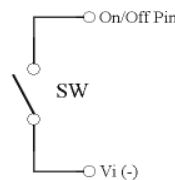

When PXA15 module is turned on at
High logic level

b. Negative logic – The DC/DC module is turned on when the ON/OFF pin is at low logic level. A high logic level signal is needed to turn off the device.

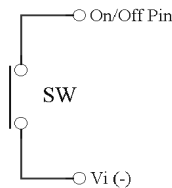

When PXA15 module is turned on at
Low logic level

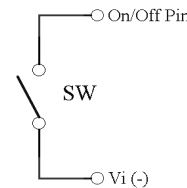

When PXA15 module is turned off at
High logic level

Testing Configurations

Input reflected-ripple current measurement

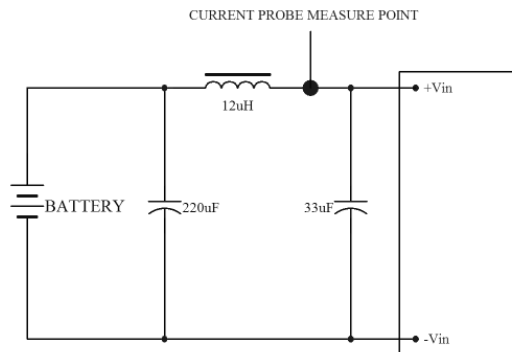

Peak-to-peak output ripple & noise measurement

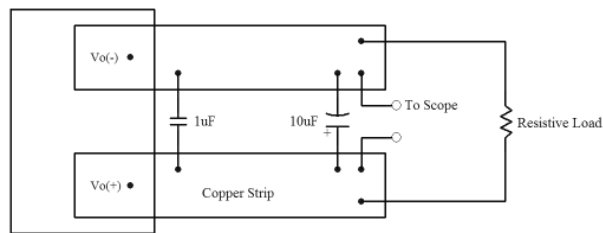

Output voltage and efficiency measurement

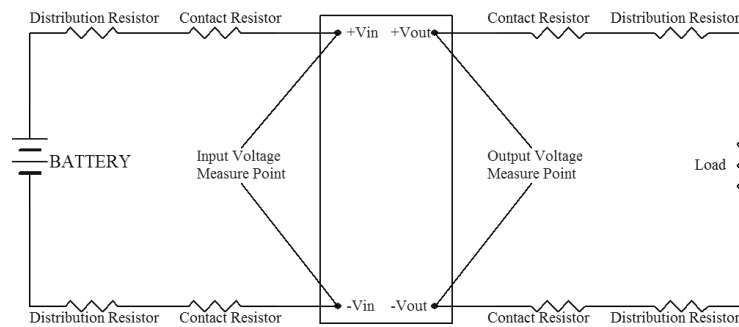

Note: All measurements are taken at the module terminals.

$$Efficiency = \left(\frac{V_{out} \times I_{out}}{V_{in} \times I_{in}} \right) \times 100\%$$

Mechanical Data

DIP TYPE

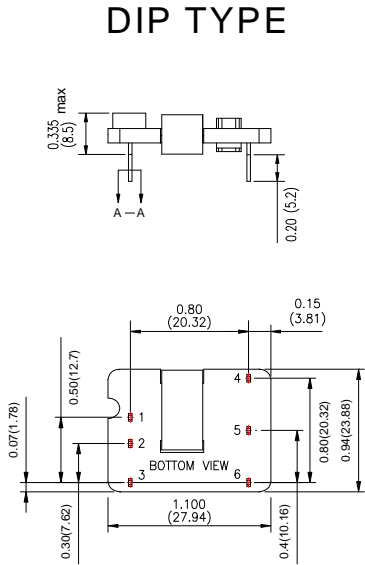

SMD TYPE

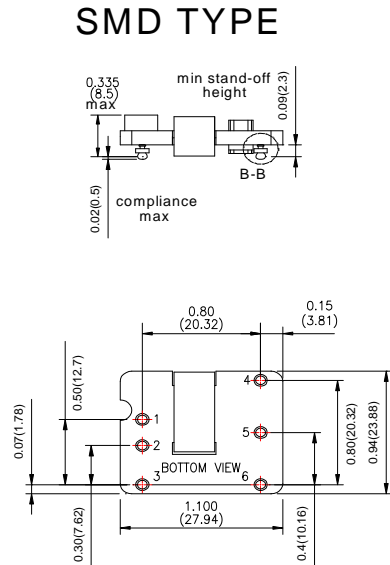

1. All dimensions in inches(mm)
2. Tolerance : $x.xx \pm 0.02 (x.xx \pm 0.5)$
 $x.xxx \pm 0.010 (x.xx \pm 0.25)$
3. Pin pitch tolerance $\pm 0.014 (0.35)$

PIN CONNECTION	
PIN	PXA15 SERIES
1	+ INPUT
2	- INPUT
3	ON/OFF
4	+VOUT
5	TRIM
6	-VOUT

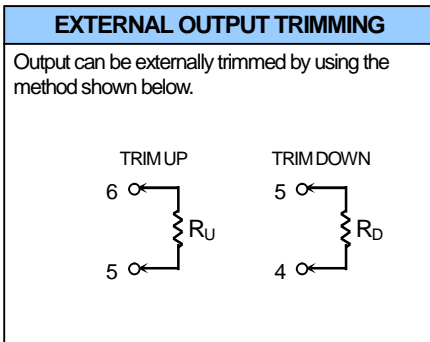

PRODUCT STANDARD TABLE

Option	Suffix
Negative remote ON/OFF with DIP	
Negative remote ON/OFF with SMT	-A
Positive remote ON/OFF with DIP	-B
Positive remote ON/OFF with SMT	-C
DIP type without ON/OFF pin	-D
SMT type without ON/OFF pin	-E
DIP type,negative remote ON/OFF without TRIM pin	-F
SMT type,negative remote ON/OFF without TRIM pin	-G
DIP type without ON/OFF&TRIM pin	-H
SMT type without ON/OFF&TRIM pin	-I
DIP type,positive remote ON/OFF without TRIM pin	-J
SMT type,positive remote ON/OFF without TRIM pin	-K

Recommended Pad Layout

Recommended pad layout for DIP type

ALL Dimensions in millimeters (inches)
 Tolerances: xx.xx mm ±0.25mm (xx.xxx in ±0.010 in)

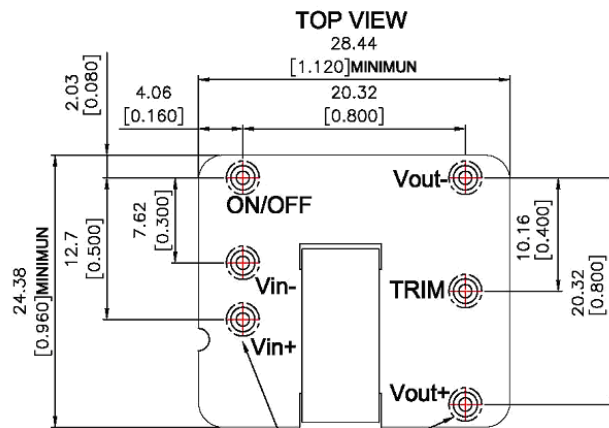

PAD SIZE
 THROUGH HOLE: ϕ 1.2mm
 TOP VIEW PAD: ϕ 2.0mm (LEFD FREE RECOMMENDED)
 BOTTOM VIEW PAD: ϕ 3.0mm

Recommended pad layout for SMD type

ALL Dimensions in millimeters (inches)
 Tolerances: xx.xx mm ±0.25mm (xx.xxx in ±0.010 in)

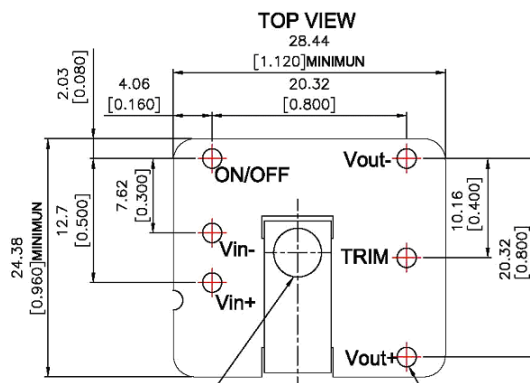

RECOMMENDED PICK AND PLACE

6-PAD SIZE
 MINIMUM: ϕ 1.9mm
 RECOMMENDED: ϕ 2.8mm

Soldering and Reflow Considerations

Lead free wave solder profile for DIP type

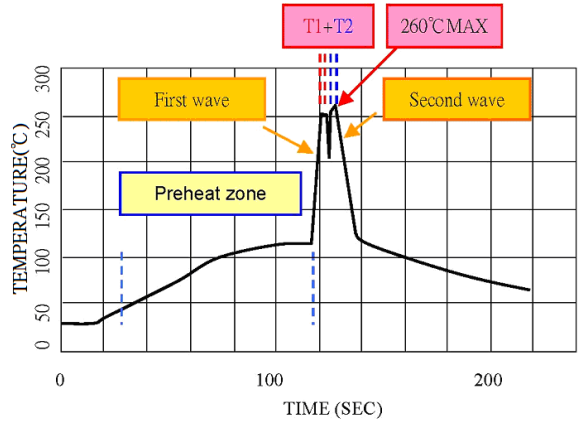

Zone	Reference Parameter.
Preheat zone	Rise temp. speed: 3 °C/sec max. Preheat temp.100~130 °C
Actual heating	Peak temp. :250~260 °C Peak time(T1+T2 time):4~6 sec

Lead free reflow profile for SMD type

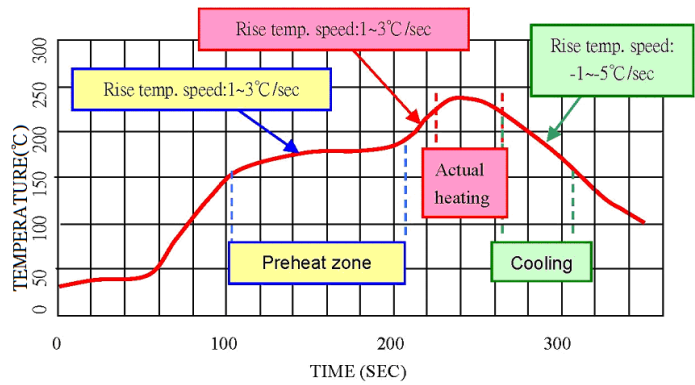

Zone	Reference Parameter.
Preheat zone	Rise temp. speed:1~3 °C/sec Preheat time:60~90sec Preheat temp.155~185 °C
Actual heating	Rise temp. speed:1~3 °C/sec Melting time:20~40 sec Melting temp:220 °C Peak temp. :230~240v Peak time:10~20 sec
Cooling	Rise temp. speed: -1~5 °C/sec

Clearing and Drying Considerations**Cleaning process**

a. PWB cooling prior to cleaning:

Power modules and their associated application PWB assemblies should not be cleaned after soldering until the power modules have had an opportunity to cool to within the cleaning solution temperature. This will prevent vacuum absorption of the cleaning liquid into the module between the pins and the potting during cooling.

b. Cleaning process:

In aqueous cleaning, it is preferred to have an in-line system consisting of several cleaning stages (prewash, wash, rinse, final rinse, and drying). De-ionized (DI) water is recommended for aqueous cleaning; the minimum resistivity level is 1M Ω -cm. Tap-water quality varies per region in terms of hardness, chloride, and solid contents; therefore, the use of tap water is not recommended for aqueous cleaning. The total time of ultrasonic wave shall be less than 3 minutes.

Drying

After cleaning, dry converters at 100 °C, more than 10minutes to assure that the moisture and other potential foreign contaminants are driven out. For open power module construction with having transformers and inductors that have unspotted windings, a baking process of 100 °C for 30 min. is recommended for the assembly to ensure that the moisture and other potential foreign contaminants are driven out from the open windings.

The drying section of the cleaning system should be equipped with blowers capable of generating 1000 cfm-1500 cfm of air so that the amount of rinse water left to be dried off with heat is minimal. Handheld air guns are not recommended due to the variability and inconsistency of the operation.

Product Post-wash external appearance

The marking or date-code may fade or disappear after cleaning.

Packaging Information

Packaging information for DIP type

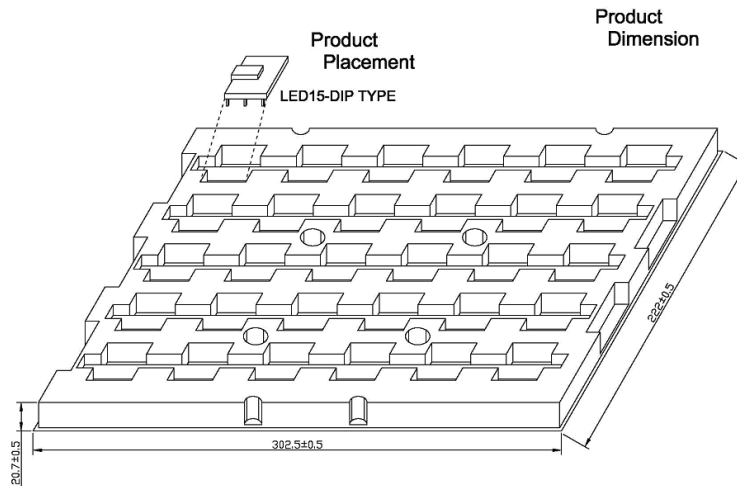

Notes:
 1. Material: PS (thick=1.2mm)

Packaging information for SMD type

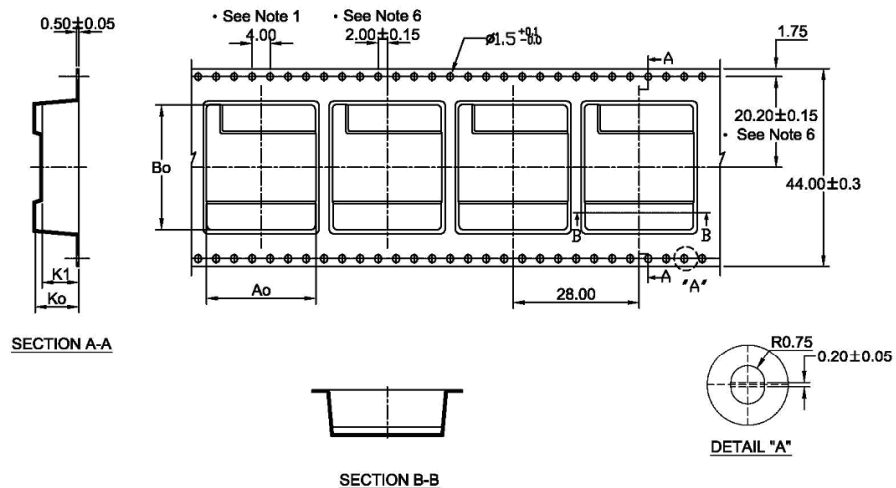

- Notes:
1. 10 sprocket hole pitch cumulative tolerance ± 0.2
 2. Camber not to exceed 1mm in 100mm.
 3. Material: Black Advantek Polystyrene.
 4. A_o and B_o measured on a plane 0.3mm above the bottom of the pocket.
 5. K_o measured from a plane on the inside bottom of the pocket to the top surface of the carrier tape.
 6. Pocket position relative to sprocket hole measured as true position of pocket, not pocket hole.

$A_o=24.30\text{mm}$
 $B_o=27.80\text{mm}$
 $K_o= 9.70\text{mm}$
 $K1= 8.20\text{mm}$

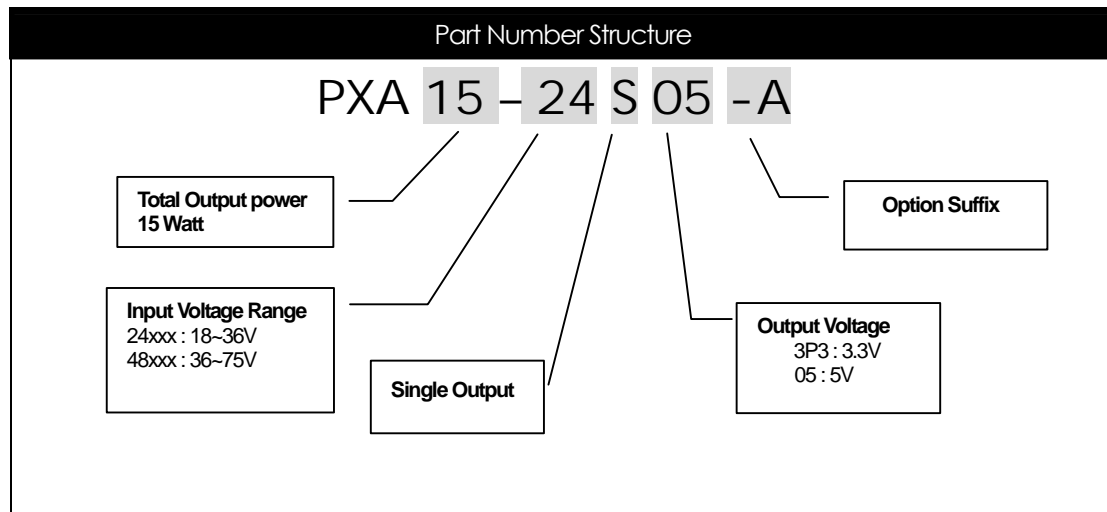

Safety and Installation Instruction

Isolation consideration

The PXA15 series features 2250 Volt DC isolation from input to output. The input to output resistance is greater than 10 megohms. Nevertheless, if the system using the power module needs to receive safety agency approval, certain rules must be followed in the design of the system using the model. In particular, all of the creepage and clearance requirements of the end-use safety requirement must be observed. These documents include UL60950-1, EN60950-1 and CSA 22.2-960, although specific applications may have other or additional requirements.

Fusing Consideration

Caution: This power module is not internally fused. An input line fuse must always be used.

This encapsulated power module can be used in a wide variety of applications, ranging from simple stand-alone operation to an integrated part of sophisticated power architecture. For maximum flexibility, internal fusing is not included; however, to achieve maximum safety and system protection, always use an input line fuse. The safety agencies require a normal-blow fuse with maximum rating of 2A. Based on the information provided in this data sheet on Inrush energy and maximum dc input current; the same type of fuse with lower rating can be used. Refer to the fuse manufacturer's data for further information.

MTBF and Reliability

The MTBF of PXA15 series of DC/DC converters has been calculated using

Bellcore TR-NWT-000332 Case I: 50% stress, Operating Temperature at 40 °C (Ground fixed and controlled environment)

The resulting figure for MTBF is 2.2×10^6 hours.