

250W, 9 to 40V, or 9 to 53V Input Non-Isolated Ruggedized DC-DC Buck Converters

<https://product.tdk.com/en/power/rga>
www.emea.lambda.tdk.com/rga

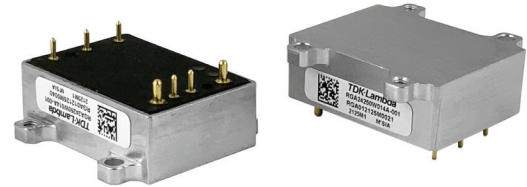

The rugged RGA non-isolated DC-DC step-down converters are encapsulated in a five-sided aluminum case and rated for up to 110°C operation. The modules have the industry standard 1/16th brick pin-out, are qualified to MIL-STD-810G (shock and vibration) and designed for fan-less, conduction cooled applications. The series accepts a wide input range to support multiple DC bus and battery voltages. Standard and optional features include remote on/off, remote sense, power good, frequency synchronization and output sequencing, making the modules a truly versatile power solution. The wide output adjustment range allows one model to be used in multiple positions, assisting inventory and part number reduction.

Features	Benefits
• Up to 250W in a 1/16th Brick Pin-Out	• High Power Density, Less Board Area Needed
• Encapsulated in a 5-sided Aluminum case	• Improves EMI
• 110 °C maximum case temperature	• Ruggedized deployment in harsh environment with high shock & vibration exposure
• Efficiency - Up to 98%	• Longer Battery Life / Low Power Consumed
• Wide 3.3 to 15V, 3.3 to 24V or 3.3 to 40V Output Adjustment	• One Part Supports Multiple System Voltages
• Wide 9 to 40V or 9 to 53V Input Range	• Can Operate From Different DC Source Voltages
• Low Component Count With Minimal External Components	• Low Cost

Model Selector						
Model	Input Voltage (V)	Output Voltage (V)	Max Current (A)	Max Power (W)	Negative Logic On/Off	Full Feature*
RGA24250W014A-001	9 - 40	3.3 - 24	14	250	Yes	No
RGA24250W014A-003	9 - 40	3.3 - 24	14	250	Yes	Yes
RGA4W250W010A-001	9 - 53	3.3 - 40	10	250	Yes	No
RGA4W250W010A-003	9 - 53	3.3 - 40	10	250	Yes	Yes
RGA4W250W020A-001	9 - 53	3.3 - 15	20	250	Yes	No
RGA4W250W020A-003	9 - 53	3.3 - 15	20	250	Yes	Yes

Preferred model

* Full feature includes Power Good signal, Frequency Synchronization, Output Sequencing

Related Products		
Type	Part Number	Description
Ruggedized DC-DC Buck-Boost Converter	RGC	300W, Input 9-53V or 9-36V, Output 9.6-48V, 8A; 5-28V, 12.5A; or 8-24V, 20A
DC-DC Buck Converter	i7A	500-750W, Input 18-60V or 18-36V, Output 3.3-24V, 33A; or 3.3-18V, 45A
DC-DC Buck-Boost Converter	i7C	300W, Input 9-53V or 9-36V, Output 9.6-48V, 8A; 5-28V, 12.5A; or 8-24V, 20A
DC-DC Buck Converter	i6A4W	250W, Input 9-53V, Output 3.3-40V, 10A; 3.3-15V, 20A
Isolated DC-DC Converter	GQA	120W Industrial, Input 9-36V, Isolated Quarter Brick
Isolated DC-DC Converter	HQA	120W MIL-COTS, Input 9-40V, Isolated Quarter Brick
Evaluation Board	i367X-C01-EVK-S0	Evaluation Board with no module. Order required RGA part number separately.

Specification		RGA24250W014A	RGA4W250W010A	RGA4W250W020A
Input				
Input Voltage Range	Vdc	9 - 40	9 - 53	
Input Current (max)	A	15	20	
Standby Input Current (typ)	mA	1.5		
Turn-ON Input Voltage	Vdc	8		
Turn-OFF Input Voltage	Vdc	7 - 9		
Efficiency	%	92.5 - 98	94 - 97.5	90 - 97
Safety Certifications and Markings	-	CE, UKCA Mark		
Output				
Output Voltage Tolerance	%	± 4		
Switching Frequency	kHz	400		
Line Regulation	%	0.3	0.3	0.4
Load Regulation	%	1	0.9	1.2
External Load Capacitance	µF	0 - 2200	0 - 1500	0 - 1800
Ripple & Noise	mVpp	20	50	20
Overcurrent Protection Threshold (typ)	A	22	15	27
Overtemperature Protection	-	Yes		
Output Voltage Adjustment Range	-	See full specifications for output trim equation.		
Remote Sense	-	(+) Sense, compensating up to 5% of output voltage		
Remote On/Off	-	Negative Logic		
Power Good	-	Optional (Full Feature Version)		
Frequency Synchronization (SYNC)	-	Optional (Full Feature Version)		
Output Sequencing (SEQ)	-	Optional (Full Feature Version)		
Environmental				
Operating Temperature (Tcase)	°C	-40 to 110		
Storage Temperature	°C	-55 to 125		
Humidity (non condensing)	%RH	5 - 95 (Operating & Storage)		
Altitude ⁽²⁾	m	2000		
Cooling	-	Conduction Cooling		
Shock	-	MIL-STD-810G 516.6 Procedure I & IV		
Vibration	-	MIL-STD-810G 514.6 Procedure I, Cat 10		
Thermal Cycling Test (TCT)	-	Qualified to 700 cycles / -40 to 125°C, 60°C/min ramp, 30 min dwell time		
Other				
Weight (Typ)	g	42.5 max		
Size (LxWxH)	mm	35.6 x 35.6 x 13.0 35.6 x 25.6 x 13.0 (Mounting tab excluded)		
Size (LxWxH)	Inches	1.40 x 1.40 x 0.51 1.40 x 1.01 x 0.51 (Mounting tab excluded)		
MTBF - Telcordia SR-332	-	> 12 Mhrs; 100% Load; Ta = 40 °C		
Warranty	yrs	3 years		

Notes

(1) See website for detailed product [specification](#).

(2) Contact Technical Support for operation at higher altitudes.

Typical Application Circuit (RGA)

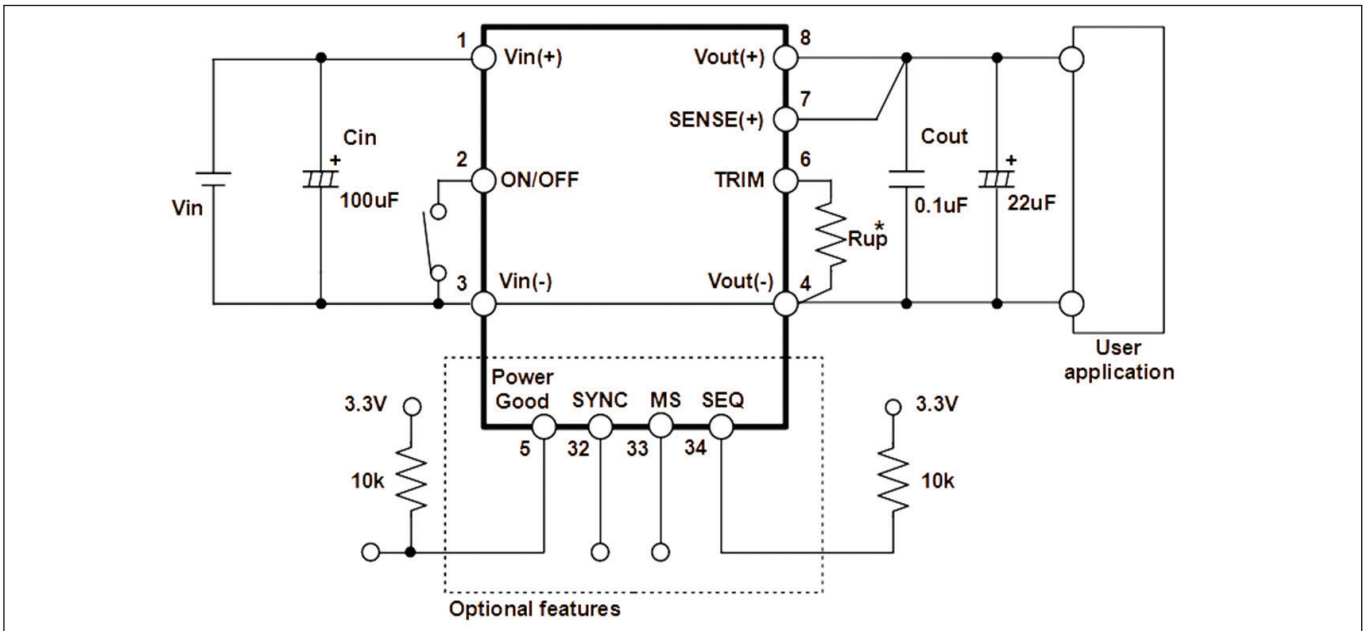

Recommendation

1. TRIM resistor Rup should be connected as close as possible to the power module.

Operating Range (RGA4W250W020A-xxx)

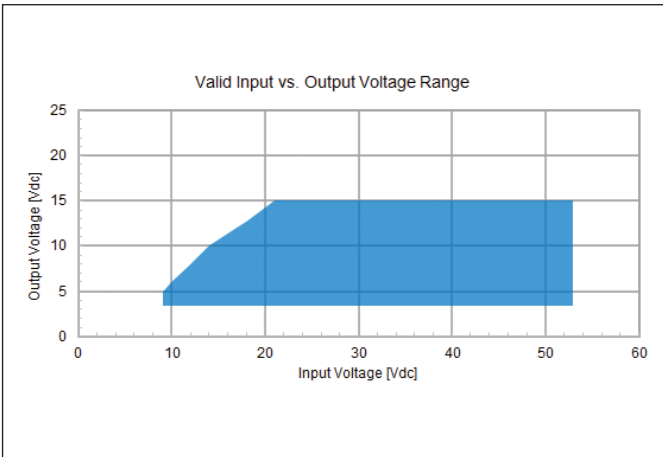

Operating Range (RGA24250W014A-xxx)

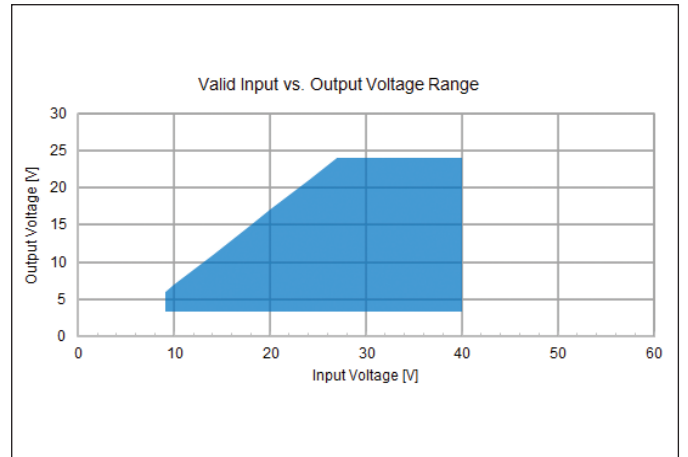

Operating Range (RGA4W250W010A-xxx)

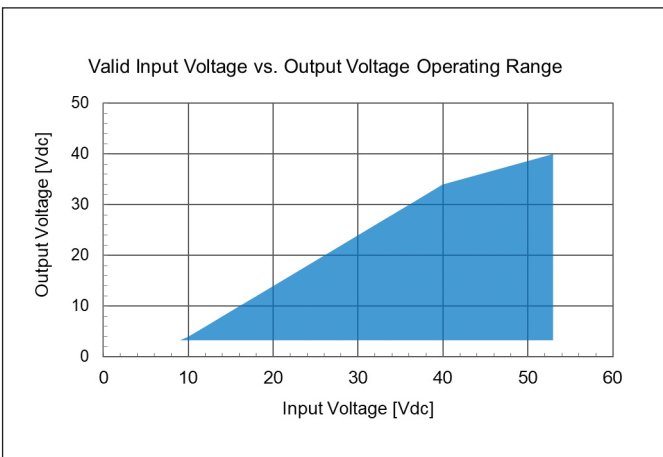

Pinout

PIN	Function	PIN	Function
1	VIN (+)	7	SENSE +
2	ON / OFF	8	VOUT (+)
3	VIN (-) / GND	32	SYNC (Option)
4	VOUT (-) / GND	33	MS (Option)
5	Power Good (Option)	34	SEQ (Option)
6	TRIM		

Pin base material is brass or copper with gold over nickel plating.

Recommended Hole Pattern (Suffix -001)

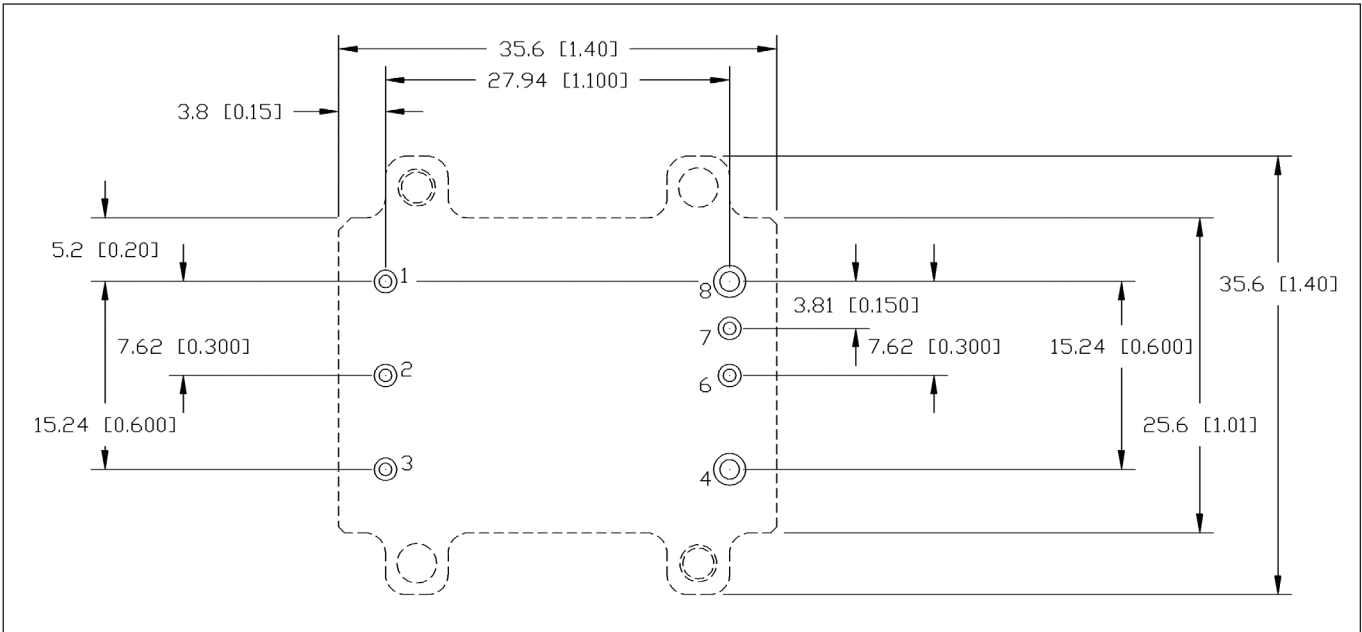

Recommended PCB Hole Pattern (Suffix -003)

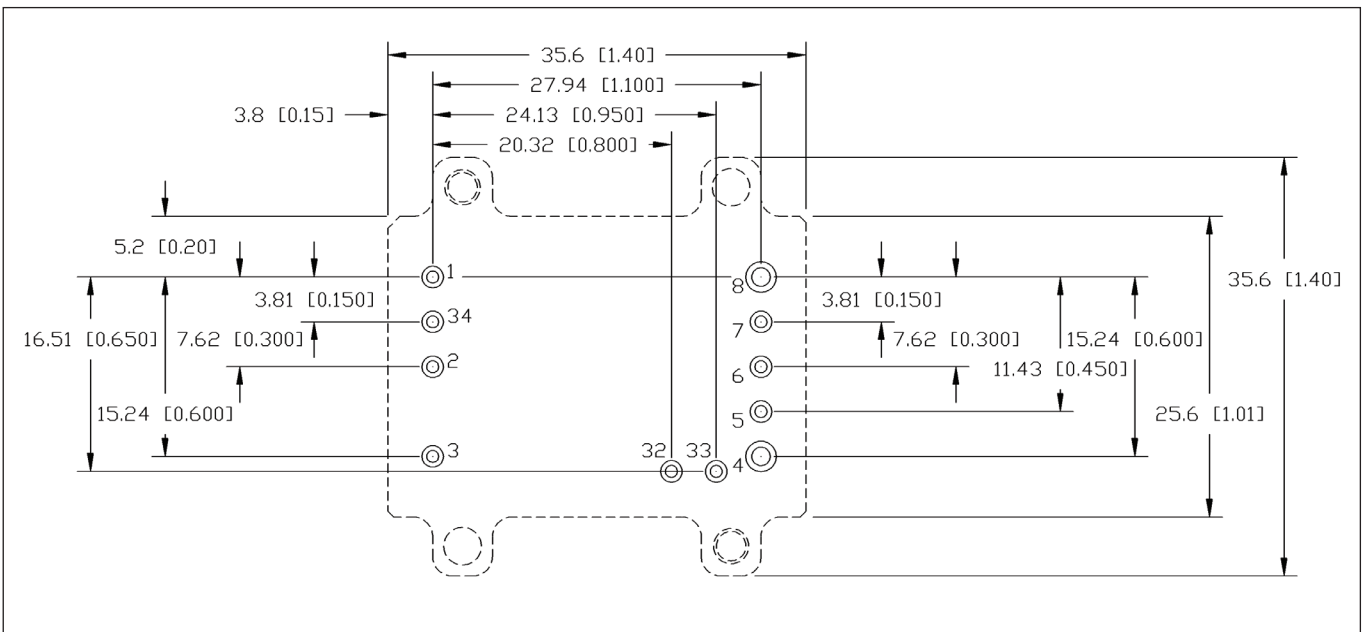



TDK-Lambda France SAS

Tel: +33 1 60 12 71 65
 tif.fr.powersolutions@tdk.com
 www.emea.lambda.tdk.com/fr



Italy Sales Office

Tel: +39 02 61 29 38 63
 tif.it.powersolutions@tdk.com
 www.emea.lambda.tdk.com/it



Netherlands

tif.nl.powersolutions@tdk.com
 www.emea.lambda.tdk.com/nl



TDK-Lambda Germany GmbH

Tel: +49 7841 666 0
 tlg.powersolutions@tdk.com
 www.emea.lambda.tdk.com/de



Austria Sales Office

Tel: +43 2256 655 84
 tlg.at.powersolutions@tdk.com
 www.emea.lambda.tdk.com/at



Switzerland Sales Office

Tel: +41 44 850 53 53
 tlg.ch.powersolutions@tdk.com
 www.emea.lambda.tdk.com/ch



Nordic Sales Office

Tel: +45 8853 8086
 tlg.dk.powersolutions@tdk.com
 www.emea.lambda.tdk.com/dk



TDK-Lambda UK Ltd.

Tel: +44 (0) 12 71 85 66 66
 tlu.powersolutions@tdk.com
 www.emea.lambda.tdk.com/uk



TDK-Lambda Ltd.

Tel: +9 723 902 4333
 tli.powersolutions@tdk.com
 www.emea.lambda.tdk.com/il-en



TDK-Lambda Americas

Tel: +1 800-LAMBDA-4 or 1-800-526-2324
 tla.powersolutions@tdk.com
 www.us.lambda.tdk.com



TDK Electronics do Brasil Ltda

Tel: +55 11 3289-9599
 sales.br@tdk-electronics.tdk.com
 www.tdk-electronics.tdk.com/en



TDK-Lambda Corporation

Tel: +81-3-6778-1113
 www.jp.lambda.tdk.com



TDK-Lambda (China) Electronics Co. Ltd.

Tel: +86 21 6485-0777
 tlc.powersolutions@tdk.com
 www.lambda.tdk.com.cn



TDK-Lambda Singapore Pte Ltd.

Tel: +65 6251 7211
 tls.marketing@tdk.com
 www.sg.lambda.tdk.com



TDK India Private Limited, Power Supply Division

Tel: +91 80 4039-0660
 mathew.philip@tdk.com
 www.sg.lambda.tdk.com

