

SERIES: PDME2-S | **DESCRIPTION:** DC-DC CONVERTER

FEATURES

- 2 W isolated output
- single/dual unregulated output
- 1500 Vdc isolation
- continuous short circuit protection
- extended temperature range (-40~105°C)
- no-load input current as low as 8mA
- efficiency up to 86%
- UL 62368-1 certified
- designed to meet EN/BS EN 62368

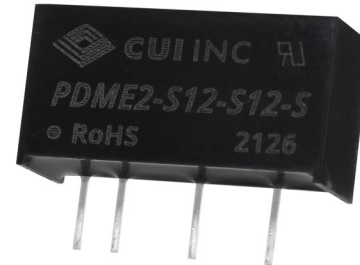

| MODEL | input voltage | | output voltage (Vdc) | output current | | output power max (W) | ripple & noise ¹ max (mVp-p) | efficiency ² typ (%) |
|------------------------------|---------------|----------------|-------------------------|----------------|-------------|----------------------------|---|---------------------------------------|
| | typ (Vdc) | range (Vdc) | | min (mA) | max (mA) | | | |
| PDME2-S5-D3-S ⁴ | 5 | 4.5~5.5 | ±3.3 | ±30 | ±303 | 2 | 200 | 75 |
| PDME2-S5-D5-S ⁴ | 5 | 4.5~5.5 | ±5 | ±20 | ±200 | 2 | 200 | 84 |
| PDME2-S5-D9-S ⁴ | 5 | 4.5~5.5 | ±9 | ±11 | ±111 | 2 | 200 | 85 |
| PDME2-S5-D12-S ⁴ | 5 | 4.5~5.5 | ±12 | ±8 | ±83 | 2 | 200 | 85 |
| PDME2-S5-D15-S ⁴ | 5 | 4.5~5.5 | ±15 | ±7 | ±67 | 2 | 200 | 86 |
| PDME2-S5-D24-S ⁴ | 5 | 4.5~5.5 | ±24 | ±4 | ±42 | 2 | 200 | 86 |
| PDME2-S5-S3-S ⁴ | 5 | 4.5~5.5 | 3.3 | 40 | 400 | 1.32 | 200 | 78 |
| PDME2-S5-S5-S ⁴ | 5 | 4.5~5.5 | 5 | 40 | 400 | 2 | 200 | 84 |
| PDME2-S5-S7-S ⁴ | 5 | 4.5~5.5 | 7.2 | 28 | 278 | 2 | 200 | 84 |
| PDME2-S5-S9-S ⁴ | 5 | 4.5~5.5 | 9 | 22 | 222 | 2 | 200 | 85 |
| PDME2-S5-S12-S ⁴ | 5 | 4.5~5.5 | 12 | 17 | 167 | 2 | 200 | 85 |
| PDME2-S5-S15-S ⁴ | 5 | 4.5~5.5 | 15 | 13 | 133 | 2 | 200 | 86 |
| PDME2-S5-S24-S ⁴ | 5 | 4.5~5.5 | 24 | 8 | 83 | 2 | 200 | 86 |
| PDME2-S12-D3-S | 12 | 10.8~13.2 | ±3.3 | ±30 | ±303 | 2 | 180 | 75 |
| PDME2-S12-D5-S | 12 | 10.8~13.2 | ±5 | ±20 | ±200 | 2 | 180 | 80 |
| PDME2-S12-D9-S ⁴ | 12 | 10.8~13.2 | ±9 | ±11 | ±111 | 2 | 180 | 82 |
| PDME2-S12-D12-S | 12 | 10.8~13.2 | ±12 | ±8 | ±83 | 2 | 180 | 83 |
| PDME2-S12-D15-S | 12 | 10.8~13.2 | ±15 | ±7 | ±67 | 2 | 180 | 83 |
| PDME2-S12-D24-S ⁴ | 12 | 10.8~13.2 | ±24 | ±4 | ±42 | 2 | 180 | 83 |
| PDME2-S12-S5-S | 12 | 10.8~13.2 | 5 | 40 | 400 | 2 | 180 | 82 |
| PDME2-S12-S9-S ⁴ | 12 | 10.8~13.2 | 9 | 22 | 222 | 2 | 180 | 82 |
| PDME2-S12-S12-S | 12 | 10.8~13.2 | 12 | 17 | 167 | 2 | 180 | 84 |
| PDME2-S12-S15-S | 12 | 10.8~13.2 | 15 | 13 | 133 | 2 | 180 | 85 |
| PDME2-S12-S24-S | 12 | 10.8~13.2 | 24 | 8 | 83 | 2 | 180 | 86 |
| PDME2-S15-D5-S ⁴ | 15 | 13.5~16.5 | ±5 | ±20 | ±200 | 2 | 180 | 80 |
| PDME2-S15-D15-S ⁴ | 15 | 13.5~16.5 | ±15 | ±7 | ±67 | 2 | 180 | 82 |
| PDME2-S15-S5-S ⁴ | 15 | 13.5~16.5 | 5 | 40 | 400 | 2 | 180 | 80 |

MODEL (CONTINUED)

| | input voltage | | output voltage (Vdc) | output current | | output power max (W) | ripple & noise ¹ max (mVp-p) | efficiency ² typ (%) |
|------------------------------|---------------|----------------|-------------------------|----------------|-------------|----------------------------|---|---------------------------------------|
| | typ (Vdc) | range (Vdc) | | min (mA) | max (mA) | | | |
| PDME2-S15-S15-S ⁴ | 15 | 13.5~16.5 | 15 | 13 | 133 | 2 | 180 | 81 |
| PDME2-S15-S24-S ⁴ | 15 | 13.5~16.5 | 24 | 8 | 83 | 2 | 180 | 81 |
| PDME2-S24-D3-S ⁴ | 24 | 21.6~26.4 | ±3.3 | ±30 | ±300 | 2 | 180 | 76 |
| PDME2-S24-D5-S | 24 | 21.6~26.4 | ±5 | ±20 | ±200 | 2 | 180 | 80 |
| PDME2-S24-D9-S ⁴ | 24 | 21.6~26.4 | ±9 | ±11 | ±111 | 2 | 180 | 81 |
| PDME2-S24-D12-S | 24 | 21.6~26.4 | ±12 | ±8 | ±83 | 2 | 180 | 83 |
| PDME2-S24-D15-S | 24 | 21.6~26.4 | ±15 | ±7 | ±67 | 2 | 180 | 83 |
| PDME2-S24-D24-S ⁴ | 24 | 21.6~26.4 | ±24 | ±4 | ±42 | 2 | 180 | 83 |
| PDME2-S24-S3-S ⁴ | 24 | 21.6~26.4 | 3.3 | 40 | 400 | 1.32 | 180 | 76 |
| PDME2-S24-S5-S | 24 | 21.6~26.4 | 5 | 40 | 400 | 2 | 180 | 80 |
| PDME2-S24-S9-S ⁴ | 24 | 21.6~26.4 | 9 | 22 | 222 | 2 | 180 | 81 |
| PDME2-S24-S12-S | 24 | 21.6~26.4 | 12 | 17 | 167 | 2 | 180 | 84 |
| PDME2-S24-S15-S | 24 | 21.6~26.4 | 15 | 13 | 133 | 2 | 180 | 86 |
| PDME2-S24-S24-S | 24 | 21.6~26.4 | 24 | 8 | 83 | 2 | 180 | 86 |

- Notes:
1. Measured at nominal input, 20 MHz bandwidth oscilloscope, with 10 µF tantalum and 1 µF ceramic capacitors on the output.
 2. Measured at nominal input voltage, full load.
 3. All specifications are measured at T_a=25°C, humidity < 75%, nominal input voltage, and rated output load unless otherwise specified.
 4. Model is not UL certified.

PART NUMBER KEY

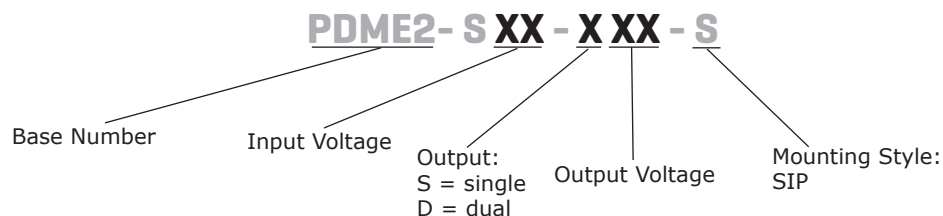

INPUT

| parameter | conditions/description | min | typ | max | units |
|-------------------------|-------------------------|--------------------|-----|------|-------|
| operating input voltage | 5 Vdc input models | 4.5 | 5 | 5.5 | Vdc |
| | 12 Vdc input models | 10.8 | 12 | 13.2 | Vdc |
| | 15 Vdc input models | 13.5 | 15 | 16.5 | Vdc |
| | 24 Vdc input models | 21.6 | 24 | 26.4 | Vdc |
| surge voltage | for maximum of 1 second | | | | |
| | 5 Vdc input models | -0.7 | | 9 | Vdc |
| | 12 Vdc input models | -0.7 | | 18 | Vdc |
| | 15 Vdc input models | -0.7 | | 21 | Vdc |
| current | 5 Vdc input models | | | | |
| | | 3.3 Vdc output | | 564 | mA |
| | | 5 & 7.2 Vdc output | | 500 | mA |
| | | 9 & 12 Vdc output | | 494 | mA |
| | 15 & 24 Vdc output | | 488 | mA | |
| | 12 Vdc input models | | | 208 | mA |
| | 15 Vdc input models | | | 167 | mA |
| | 24 Vdc input models | | | 104 | mA |
| filter | filter capacitor | | | | |

OUTPUT

| parameter | conditions/description | min | typ | max | units |
|--------------------------------------|----------------------------------|-----|-------|-------|-------|
| maximum capacitive load ⁵ | 3.3, 5 Vdc output models | | | 2,400 | μF |
| | ±3.3, ±5 Vdc output models | | | 1,200 | μF |
| | 9 Vdc output models | | | 1,000 | μF |
| | 12, 15 Vdc output models | | | 560 | μF |
| | 24, ±12, ±15 Vdc output models | | | 220 | μF |
| | ±9 Vdc output models | | | 470 | μF |
| | ±24 Vdc output models | | | 100 | μF |
| voltage accuracy | see output regulation curves | | | | |
| line regulation | for Vin change of 1% | | | | |
| | 3.3 Vdc output models | | | ±1.5 | % |
| | all other output models | | | ±1.2 | % |
| load regulation | from 10% to full load | | | | |
| | 3.3 Vdc output models | | 10 | | % |
| | 5 Vdc output models | | 8 | | % |
| | 9, 12 & 15 Vdc output models | | 7 | | % |
| | 24 Vdc output models | | 5 | | % |
| switching frequency | from 10% to full load | | | | |
| | 3.3 Vdc output models | | 15 | | % |
| | 5 Vdc output models | | 7 | | % |
| | 9, 12 Vdc output models | | 5 | | % |
| | 15 Vdc output models | | 4 | | % |
| temperature coefficient | 100% load, nominal input voltage | | | | |
| | 5 Vdc input models | | 220 | | kHz |
| | all other input models | | 260 | | kHz |
| temperature coefficient | at full load | | ±0.02 | | %/°C |

Note: 5. Tested at input voltage range and full load.

PROTECTIONS

| parameter | conditions/description | min | typ | max | units |
|--------------------------|---------------------------|-----|-----|-----|-------|
| short circuit protection | continuous, auto recovery | | | | |

SAFETY AND COMPLIANCE

| parameter | conditions/description | min | typ | max | units |
|-----------------------|--|-----------|-----|-----|-------|
| isolation voltage | input to output for 1 minute at 1 mA | 1,500 | | | Vdc |
| isolation resistance | input to output at 500 Vdc | 1,000 | | | MΩ |
| isolation capacitance | input to output, 100 kHz / 0.1 V | | 20 | | pF |
| safety approvals | certified to 62368: UL designed to meet 62368: EN/BS EN | | | | |
| conducted emissions | CISPR 32/EN 55032 Class B | | | | |
| radiated emissions | CISPR 32/EN 55032 Class B | | | | |
| ESD | IEC/EN 61000-4-2 Air ±8kV, Contact ±6kV | | | | |
| MTBF | as per MIL-HDBK-217F, 25°C | 3,500,000 | | | hours |
| RoHS | yes | | | | |

ENVIRONMENTAL

| parameter | conditions/description | min | typ | max | units |
|-----------------------|------------------------|-----|-----|-----|-------|
| operating temperature | see derating curves | -40 | | 105 | °C |
| storage temperature | | -55 | | 125 | °C |
| storage humidity | non-condensing | 5 | | 95 | % |
| case temperature rise | at 25°C | | 15 | | °C |

DERATING CURVES

TEMPERATURE DERATING CURVE

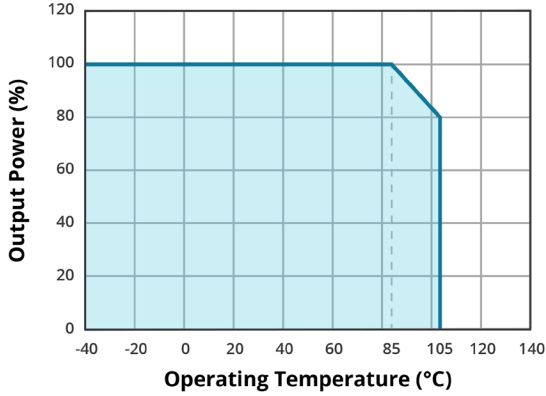

**OUTPUT REGULATION CURVE
5 Vdc input / 3.3 Vdc output
(nominal input)**

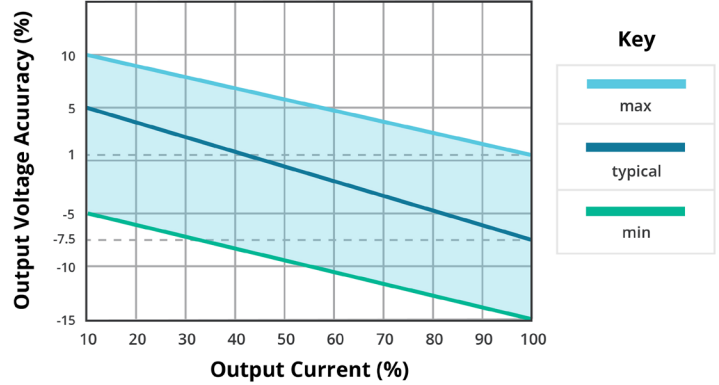

**OUTPUT REGULATION CURVE
5 Vdc input / all other output models
(nominal input)**

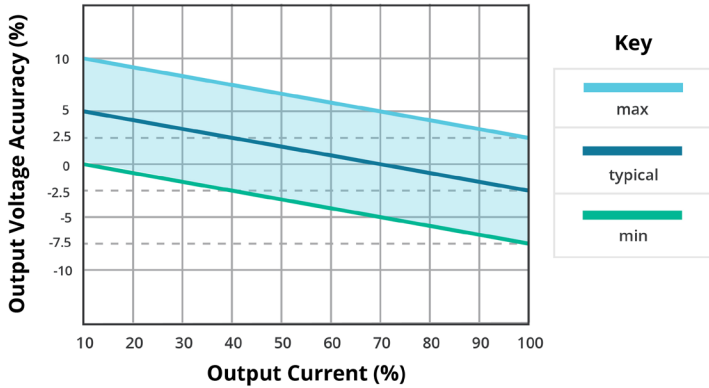

**OUTPUT REGULATION CURVE
all other input models / 3.3 Vdc output models
(nominal input)**

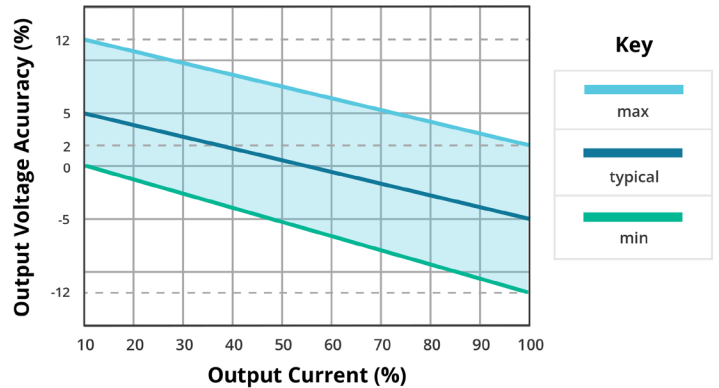

**OUTPUT REGULATION CURVE
all other input models / 5 Vdc output models
(nominal input)**

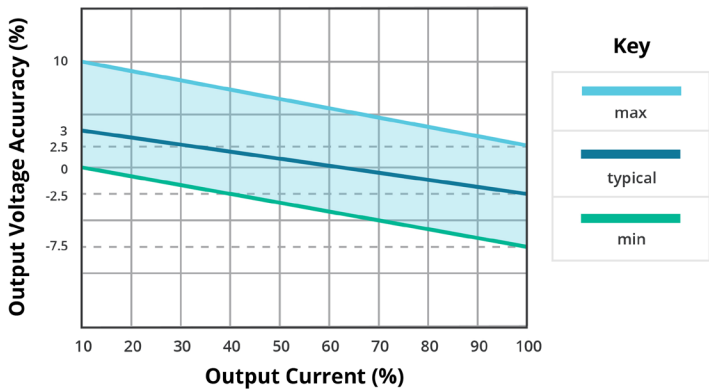

**OUTPUT REGULATION CURVE
all other input models / all other output models
(nominal input)**

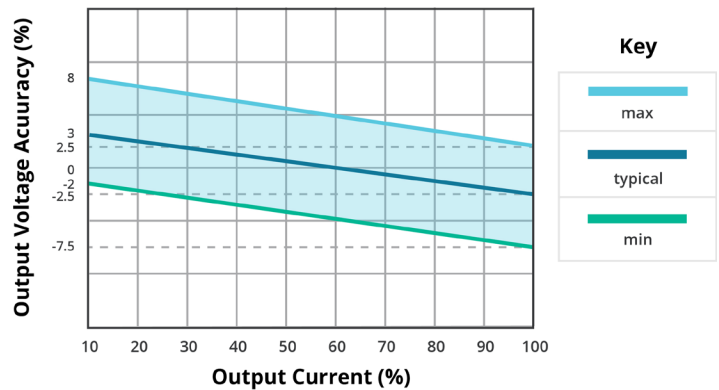

MECHANICAL

| parameter | conditions/description | min | typ | max | units |
|---------------|--|-----|-----|-----|-------|
| dimensions | 19.65 x 7.05 x 10.16 [0.773 x 0.277 x 0.400 inch] | | | | mm |
| case material | black flame-retardant and heat-resistant plastic (UL94V-0) | | | | |
| weight | | | 2.4 | | g |

MECHANICAL DRAWING

units: mm [inch]
 tolerance: $\pm 0.25[\pm 0.010]$
 pin section tolerance: $\pm 0.10[\pm 0.004]$

| PIN CONNECTIONS | | |
|-----------------|--------------------------|------------------------|
| PIN | Function / Single output | Function / Dual output |
| 1 | Vin | Vin |
| 2 | GND | GND |
| 4 | 0V | -Vo |
| 5 | No pin | 0V |
| 6 | +Vo | +Vo |

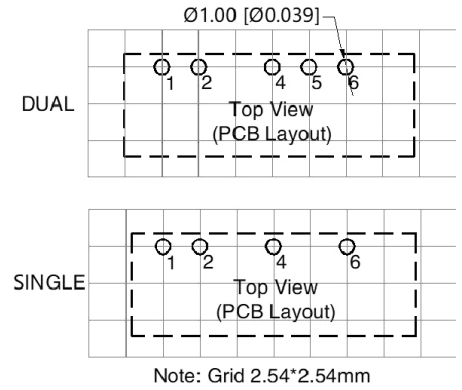
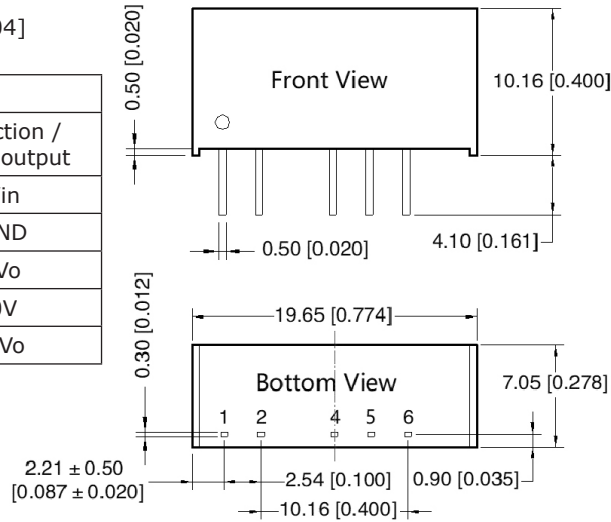

APPLICATION CIRCUIT

If you want to further reduce the input and output ripple, a filter capacitor may be connected to the input and output terminals (Figures 1 & 2) provided that the capacitance is less than the maximum capacitive load of the model, otherwise start-up problems may be caused if the capacitance is too large.

Figure 1
Single Output Models

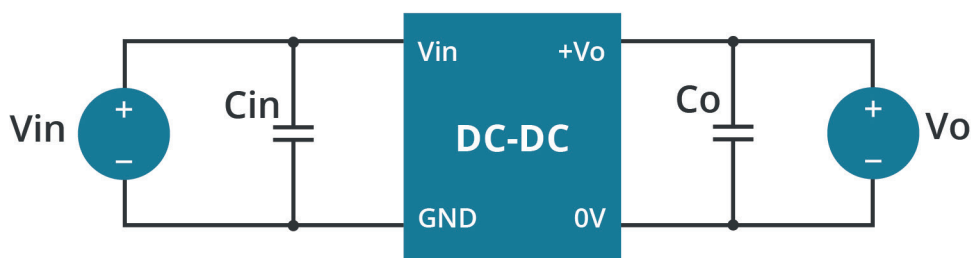

Table 1

| Vin (Vdc) | Cin (μF / V) | Vo (Vdc) | Co (μF / V) |
|-----------|--------------|----------|-------------|
| 5 | 10 / 16 | 3.3 | 10 / 16 |
| -- | -- | 5 | 10 / 16 |
| -- | -- | 7.2 | 10 / 16 |
| -- | -- | 9 | 2.2 / 25 |
| -- | -- | 12 | 2.2 / 25 |
| -- | -- | 15 | 1 / 25 |
| -- | -- | 24 | 1 / 50 |
| 12 | 2.2 / 25 | 3.3 | 10 / 16 |
| 15 | 2.2 / 25 | 5 | 10 / 16 |
| 24 | 1 / 50 | 9 | 2.2 / 25 |
| -- | -- | 12 | 2.2 / 25 |
| -- | -- | 15 | 1 / 25 |
| -- | -- | 24 | 1 / 50 |

Figure 2
Dual Output Models

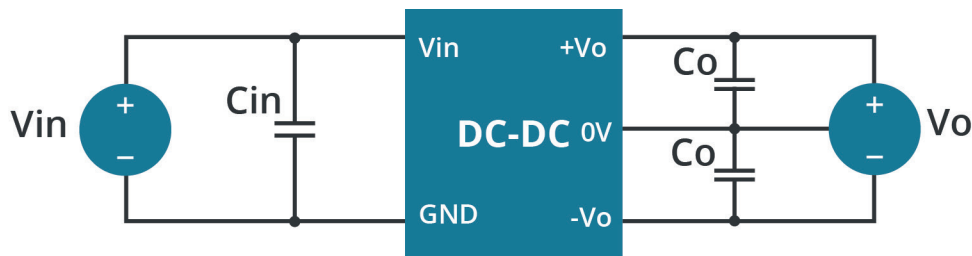

Table 2

| Vin (Vdc) | Cin (μF / V) | Vo (Vdc) | Co ⁶ (μF / V) |
|-----------|--------------|----------|--------------------------|
| 5 | 10 / 16 | ±3.3 | 4.7 / 16 |
| -- | -- | ±5 | 4.7 / 16 |
| -- | -- | ±9 | 1 / 25 |
| -- | -- | ±12 | 1 / 25 |
| -- | -- | ±15 | 0.47 / 25 |
| -- | -- | ±24 | 0.47 / 50 |
| 12 | 2.2 / 25 | ±3.3 | 4.7 / 16 |
| 15 | 2.2 / 25 | ±5 | 4.7 / 16 |
| 24 | 1 / 50 | ±9 | 2.2 / 25 |
| -- | -- | ±12 | 1 / 25 |
| -- | -- | ±15 | 1 / 25 |
| -- | -- | ±24 | 0.47 / 50 |

Note: 6. The capacitor value of the positive and the negative output is identical.

EMC RECOMMENDED CIRCUIT

Figure 3
Single Output Models

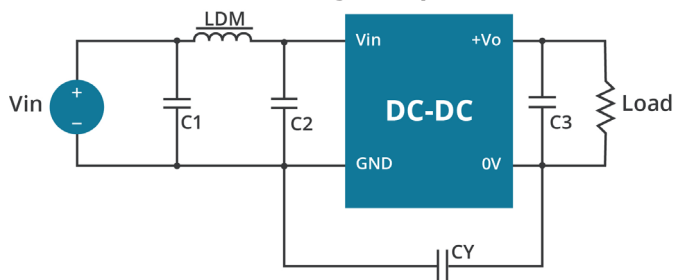

Figure 4
Dual Output Models

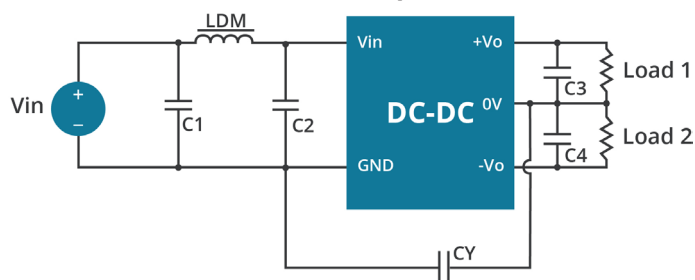

Table 3

| Recommended External Circuit Components | | | |
|---|--------------------------------|---------------|---------------|
| Vin (Vdc) | 5 | 12, 15, 24 | |
| Vo (Vdc) | all output models | 12, 15, 24 | ±12, ±15, ±24 |
| C1 / C2 | 4.7 μF / 16 V | 4.7 μF / 50 V | 4.7 μF / 50 V |
| CY | 270 pF / 2 kV | 270 pF / 2 kV | 270 pF / 2 kV |
| C3 / C4 | refer to the Co in Tables 1, 2 | | |
| LDM | 6.8 μH | 6.8 μH | 6.8 μH |

REVISION HISTORY

| rev. | description | date |
|------|---|------------|
| 1.0 | initial release | 07/26/2021 |
| 1.01 | series expanded with 5 Vdc input models | 05/24/2022 |
| 1.02 | CE removed | 11/04/2022 |

The revision history provided is for informational purposes only and is believed to be accurate.



CUI INC
a bel group

Headquarters
20050 SW 112th Ave.
Tualatin, OR 97062
800.275.4899

Fax 503.612.2383
cui.com
techsupport@cui.com

CUI offers a two (2) year limited warranty. Complete warranty information is listed on our website.

CUI reserves the right to make changes to the product at any time without notice. Information provided by CUI is believed to be accurate and reliable. However, no responsibility is assumed by CUI for its use, nor for any infringements of patents or other rights of third parties which may result from its use.

CUI products are not authorized or warranted for use as critical components in equipment that requires an extremely high level of reliability. A critical component is any component of a life support device or system whose failure to perform can be reasonably expected to cause the failure of the life support device or system, or to affect its safety or effectiveness.