

SERIES: PCN1-S | **DESCRIPTION:** DC-DC CONVERTER

FEATURES

- up to 1 W isolated output
- industry standard SIP package
- nominal input voltages: 5, 12, 24 Vdc
- single/dual unregulated output
- 1,500 Vdc isolation voltage
- low ripple and noise
- -40 to 100°C
- efficiency up to 83%

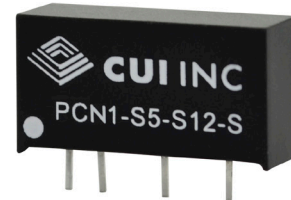

MODEL	input voltage		output voltage	output current		output power	ripple & noise ¹	efficiency
	typ (Vdc)	range (Vdc)	(Vdc)	min (mA)	max (mA)	max (W)	max (mVp-p)	typ (%)
PCN1-S5-S5-S	5	4.5~5.5	5	0	200	1	75	79
PCN1-S5-S12-S	5	4.5~5.5	12	0	84	1	75	79
PCN1-S5-S15-S	5	4.5~5.5	15	0	67	1	75	79
PCN1-S5-D5-S	5	4.5~5.5	±5	0	±100	1	75	74
PCN1-S5-D12-S	5	4.5~5.5	±12	0	±42	1	75	78
PCN1-S5-D15-S	5	4.5~5.5	±15	0	±33	1	75	78
PCN1-S12-S5-S	12	10.8~13.2	5	0	200	1	75	80
PCN1-S12-S12-S	12	10.8~13.2	12	0	84	1	75	81
PCN1-S12-S15-S	12	10.8~13.2	15	0	67	1	75	81
PCN1-S12-D5-S	12	10.8~13.2	±5	0	±100	1	75	77
PCN1-S12-D12-S	12	10.8~13.2	±12	0	±42	1	75	80
PCN1-S12-D15-S	12	10.8~13.2	±15	0	±33	1	75	81
PCN1-S24-S5-S	24	21.6~26.4	5	0	200	1	75	80
PCN1-S24-S12-S	24	21.6~26.4	12	0	84	1	75	83
PCN1-S24-S15-S	24	21.6~26.4	15	0	67	1	75	81
PCN1-S24-D5-S	24	21.6~26.4	±5	0	±100	1	75	79
PCN1-S24-D12-S	24	21.6~26.4	±12	0	±42	1	75	81
PCN1-S24-D15-S	24	21.6~26.4	±15	0	±33	1	75	82

Notes: 1. At full load, nominal input, 20 MHz bandwidth oscilloscope, with a 0.33 µF ceramic capacitor on the output.
2. Required to add a 2.2 µF (5 & 12 Vdc input models) or 4.7 µF (24 Vdc input models) ceramic capacitor to the input to reduce input voltage stress.
3. All specifications are measured at Ta=25°C, nominal input voltage, and rated output load unless otherwise specified.

PART NUMBER KEY

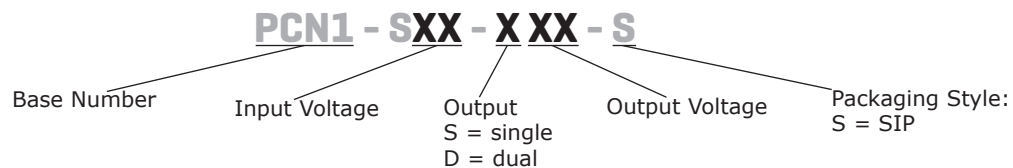

INPUT

parameter	conditions/description	min	typ	max	units
operating input voltage	5 Vdc input models	4.5	5	5.5	Vdc
	12 Vdc input models	10.8	12	13.2	Vdc
	24 Vdc input models	21.6	24	26.4	Vdc
surge voltage	for maximum of 100 ms				
	5 Vdc input models			9	Vdc
	12 Vdc input models			18	Vdc
	24 Vdc input models			30	Vdc
current	5 Vdc input models		250		mA
	12 Vdc input models		110		mA
	24 Vdc input models		50		mA
filter	capacitive				
input reverse polarity protection	no				
input fuse	0.5 A time delay fuse for all models (recommended)				

Notes: 1. Required to add a 2.2 μ F (5 & 12 Vdc input models) or 4.7 μ F (24 Vdc input models) ceramic capacitor to the input to reduce input voltage stress.

OUTPUT

parameter	conditions/description	min	typ	max	units
maximum capacitive load	single output models			220	μ F
	dual output models			100	μ F
voltage accuracy				± 3.0	%
line regulation	1.0% change in input voltage			± 1.2	%
load regulation	from 20% load to full load			± 10	%
switching frequency	at nominal Vin, full load				
	24 Vdc input models		75		kHz
	all other models		100		kHz
temperature coefficient				± 0.05	%/°C

PROTECTIONS

parameter	conditions/description	min	typ	max	units
short circuit protection	momentary			1	s

SAFETY AND COMPLIANCE

parameter	conditions/description	min	typ	max	units
isolation voltage	input to output for 1 minute	1,500			Vdc
isolation resistance	input to output	1,000			M Ω
isolation capacitance	input to output		10		pF
conducted emissions	EN 55022 Class B (external circuit required, see Figure 4)				
MTBF	as per MIL-HDBK-217F, full load, GB, 25°C		1,500,000		hours
RoHS	2011/65/EU				

ENVIRONMENTAL

parameter	conditions/description	min	typ	max	units
operating temperature	see derating curve	-40		100	°C
storage temperature		-55		125	°C
operating humidity	non-condensing			95	%

SOLDERABILITY

parameter	conditions/description	min	typ	max	units
wave soldering	see wave soldering profile			260	°C

- Notes:
1. Soldering materials: Sn/Cu/Ni
 2. Ramp up rate during preheat: 1.4°C/s (from 50°C to 100°C)
 3. Soaking temperature: 0.5°C/s (from 100°C to 130°C), 60±20 seconds
 4. Peak temperature: 260°C, above 250°C for 3~6 seconds
 5. Ramp down rate during cooling: -10°C/s (from 260°C to 150°C)

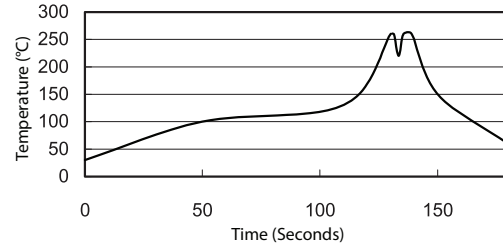

MECHANICAL

parameter	conditions/description	min	typ	max	units
dimensions	5, 12 Vdc input models: 0.77 x 0.24 x 0.40 [19.5 x 6.1 x 10.2 mm] 24 Vdc input models: 0.77 x 0.28 x 0.40 [19.5 x 7.2 x 10.2 mm]				inches inches
case material	non-conductive black plastic				
weight	24 Vdc input models all other models		2.7 1.8		g g

MECHANICAL DRAWING

units: inches [mm]
 tolerance: X.XX ±0.01 [±0.25]
 X.XXX ±0.005 [±0.13]
 pin section tolerance: ±0.002[±0.05]

PIN CONNECTIONS		
PIN	Function	
	Single	Dual
1	+Vin	+Vin
2	-Vin	-Vin
4	-Vout	-Vout
5	No pin	Common
6	+Vout	+Vout

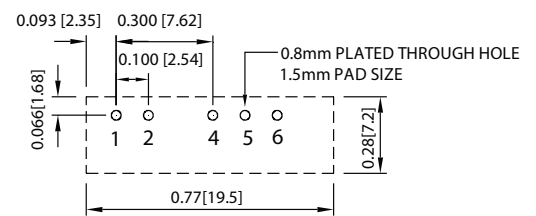
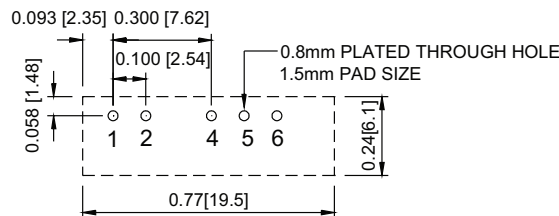
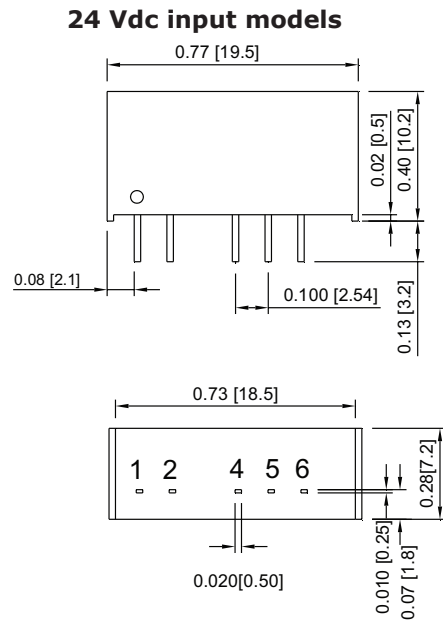
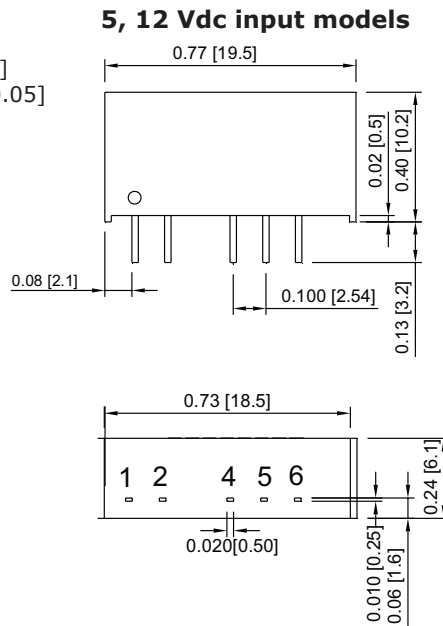

DERATING CURVE

TEMPERATURE DERATING CURVE

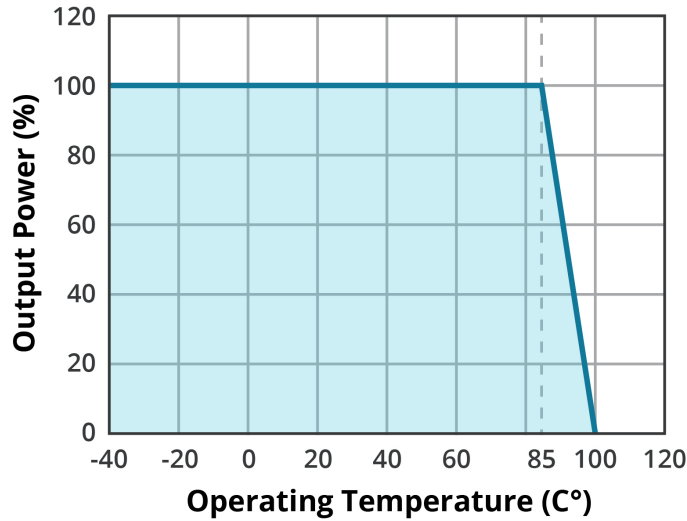

EFFICIENCY CURVES

**EFFICIENCY VS OUTPUT LOAD
PCN1-S5-S5-S**

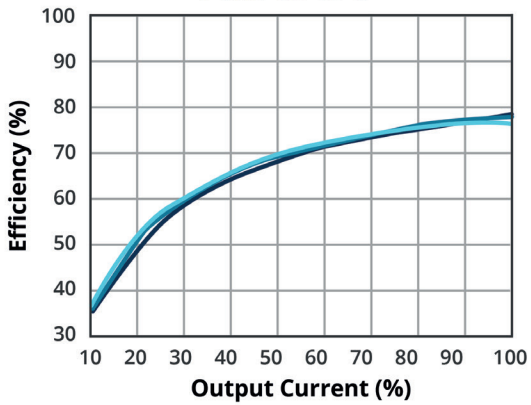

**EFFICIENCY VS OUTPUT LOAD
PCN1-S5-S12-S**

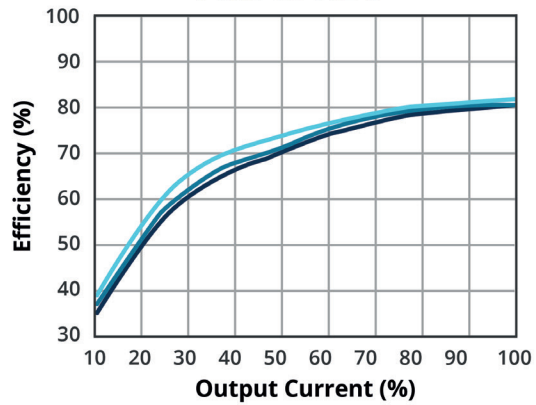

**EFFICIENCY VS OUTPUT LOAD
PCN1-S5-S15-S**

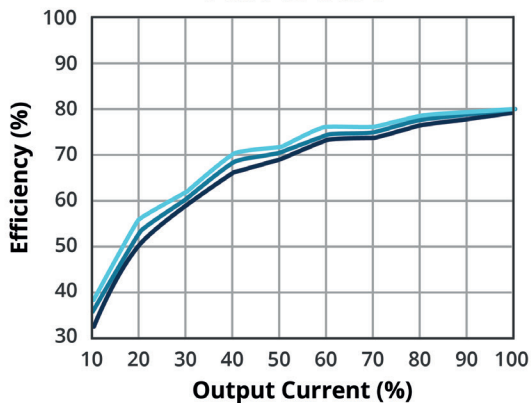

**EFFICIENCY VS OUTPUT LOAD
PCN1-S5-D5-S**

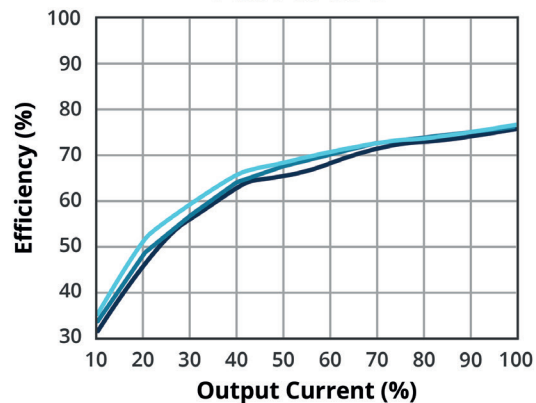

EFFICIENCY CURVES (CONTINUED)

**EFFICIENCY VS OUTPUT LOAD
PCN1-S5-D12-S**

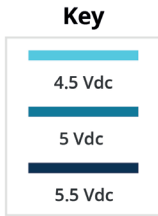
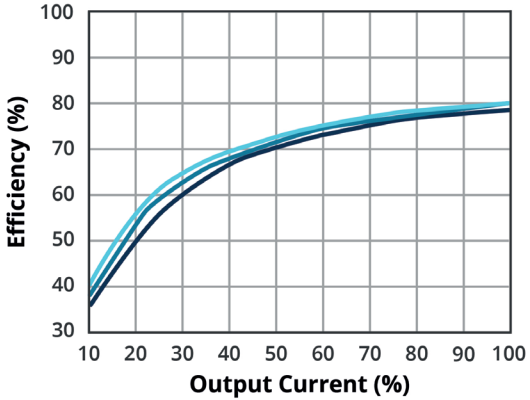

**EFFICIENCY VS OUTPUT LOAD
PCN1-S5-D15-S**

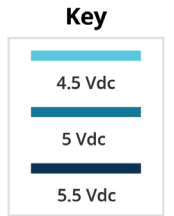
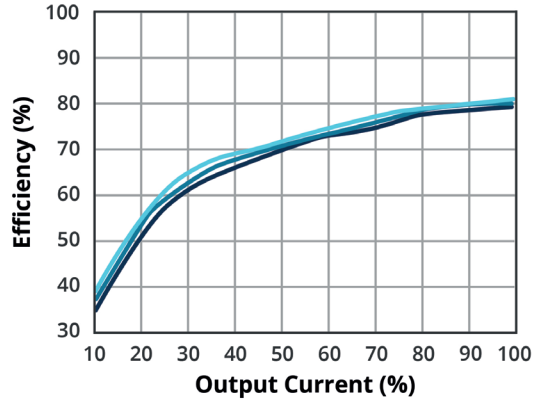

**EFFICIENCY VS OUTPUT LOAD
PCN1-S12-S5-S**

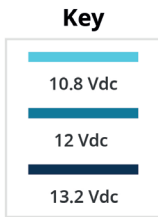
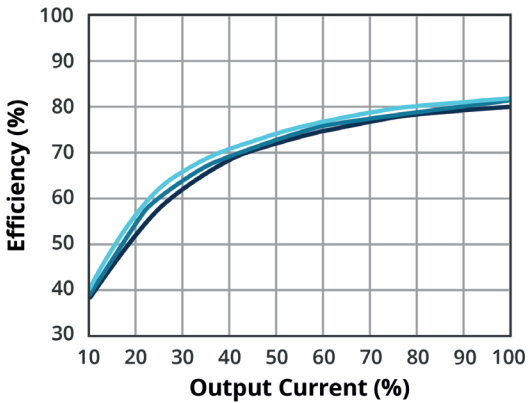

**EFFICIENCY VS OUTPUT LOAD
PCN1-S12-S12-S**

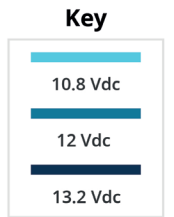
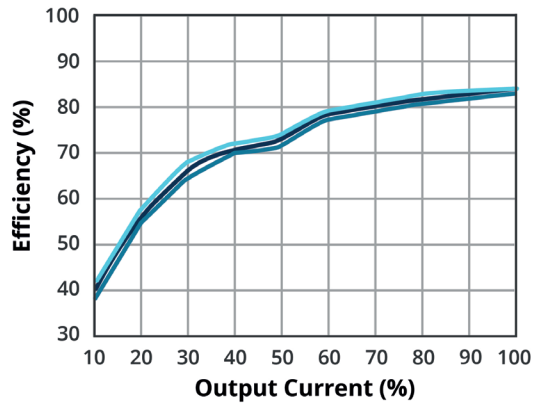

**EFFICIENCY VS OUTPUT LOAD
PCN1-S12-S15-S**

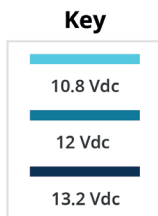
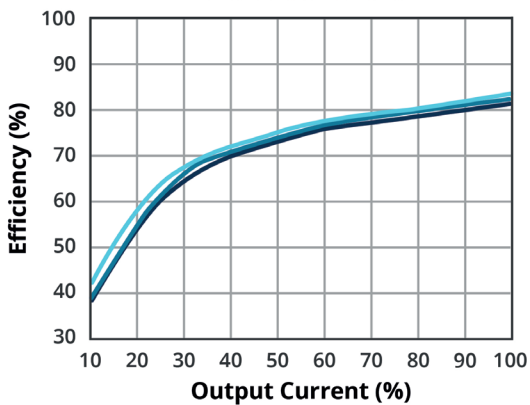

**EFFICIENCY VS OUTPUT LOAD
PCN1-S12-D5-S**

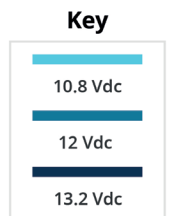
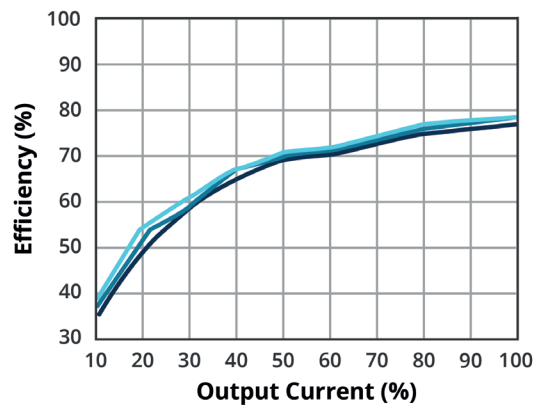

EFFICIENCY CURVES (CONTINUED)

**EFFICIENCY VS OUTPUT LOAD
PCN1-S12-D12-S**

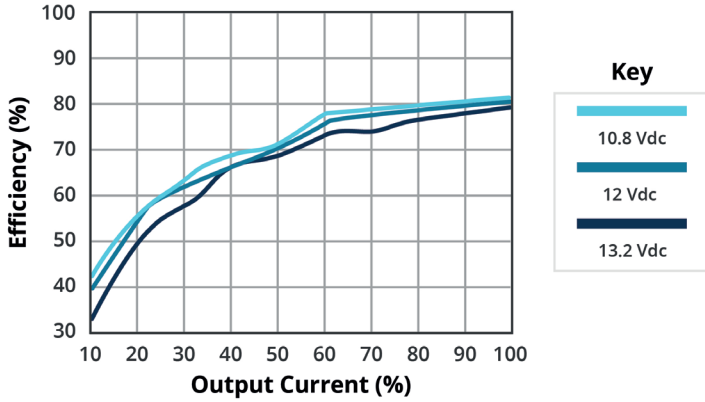

**EFFICIENCY VS OUTPUT LOAD
PCN1-S12-D15-S**

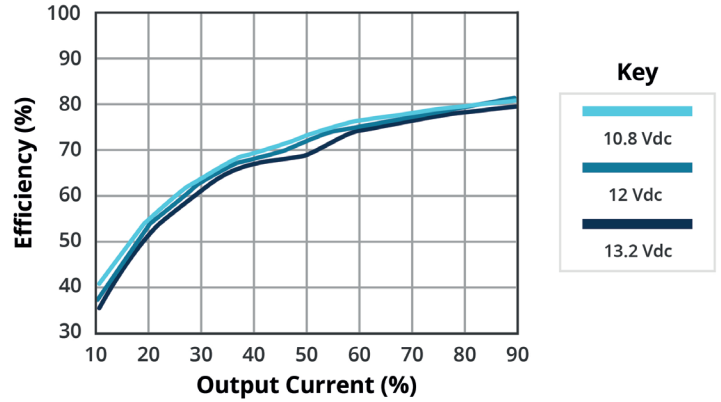

**EFFICIENCY VS OUTPUT LOAD
PCN1-S24-S5-S**

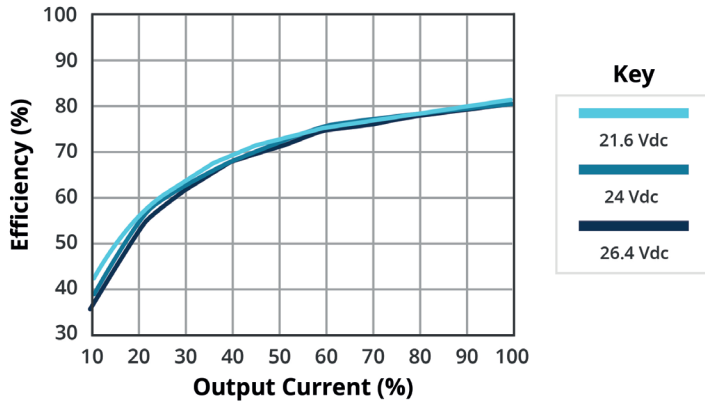

**EFFICIENCY VS OUTPUT LOAD
PCN1-S24-S12-S**

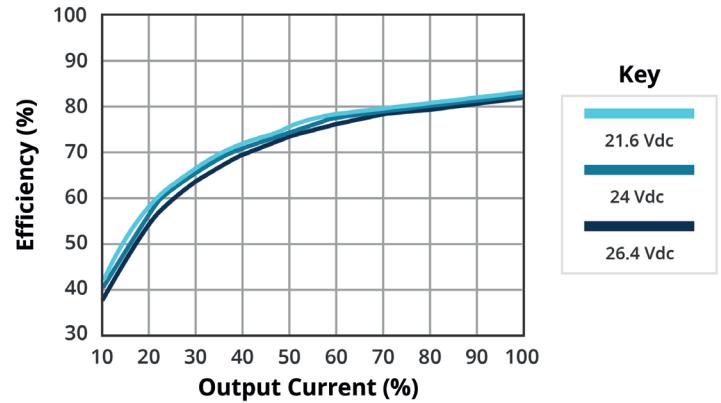

**EFFICIENCY VS OUTPUT LOAD
PCN1-S24-S15-S**

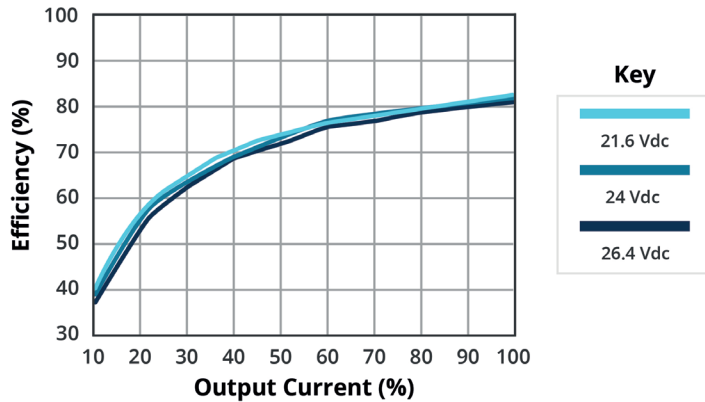

**EFFICIENCY VS OUTPUT LOAD
PCN1-S24-D5-S**

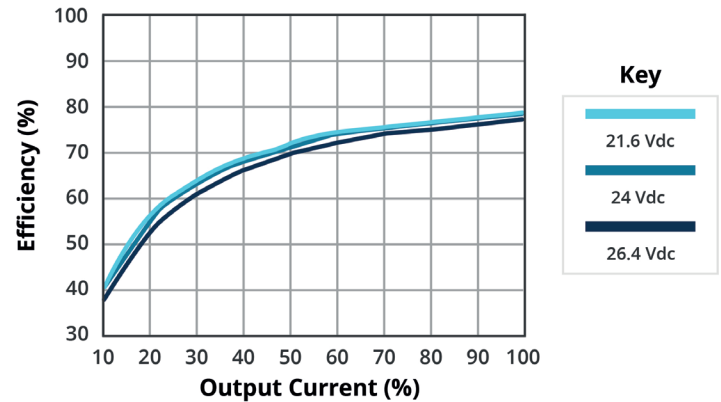

EFFICIENCY CURVES (CONTINUED)

**EFFICIENCY VS OUTPUT LOAD
PCN1-S24-D12-S**

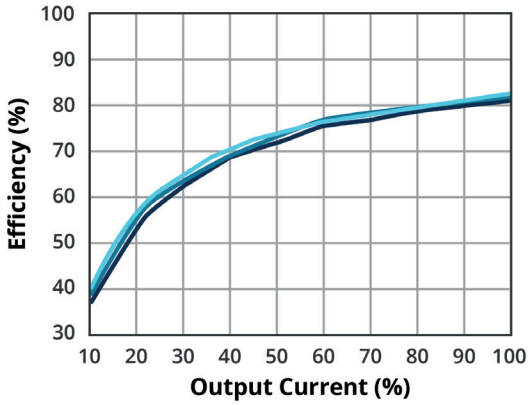

**EFFICIENCY VS OUTPUT LOAD
PCN1-S24-D15-S**

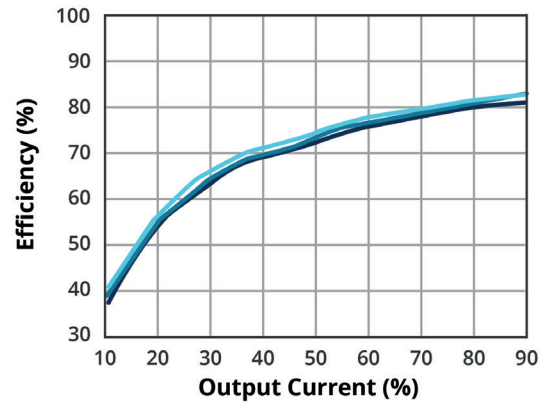

PACKAGING

5, 12 Vdc input models

units: mm

Tube size: 17.2 x 9 x 340 mm
QTY: 16 pcs

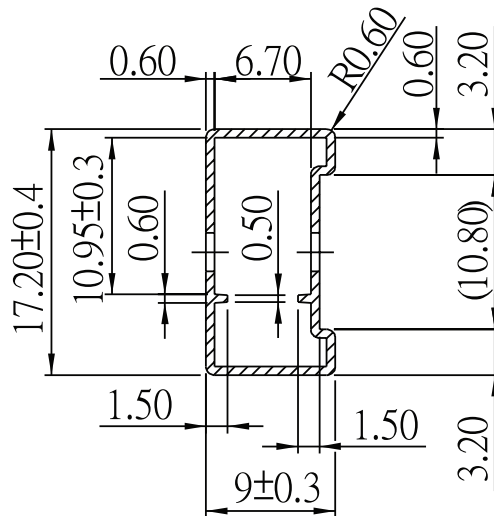

24 Vdc input models

units: mm

Tube size: 20 x 11 x 340 mm
QTY: 14 pcs

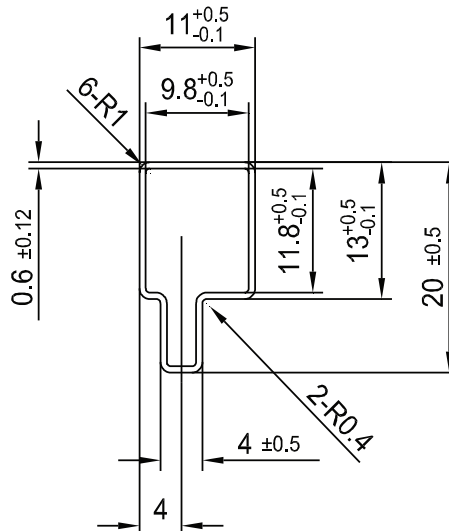

TEST CONFIGURATIONS

Input Ripple Current & Output Noise

Figure 1
Measuring Input Ripple Current

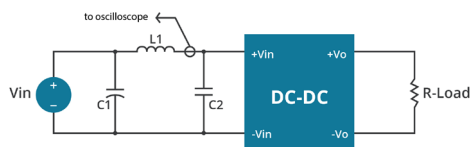

Figure 2
Measuring Output Ripple & Noise for Single Output Models

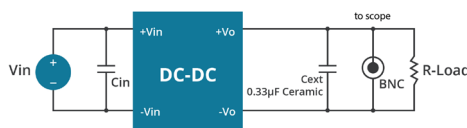

Figure 3
Measuring Output Ripple & Noise for Dual Output Models

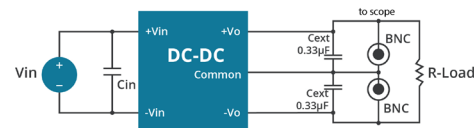

Table 1

L1	12 µH
C1	2.2 µF or 4.7 µF tantalum capacitor
C2	NC

Table 2

Input Voltage (Vdc)	Cin
5	2.2 µF ceramic capacitor
12	2.2 µF ceramic capacitor
24	4.7 µF ceramic capacitor

EMC RECOMMENDED CIRCUIT

Test Condition

Input Voltage: Nominal

Output Load: Full Load

Figure 4
Conducted Emissions Test Circuit

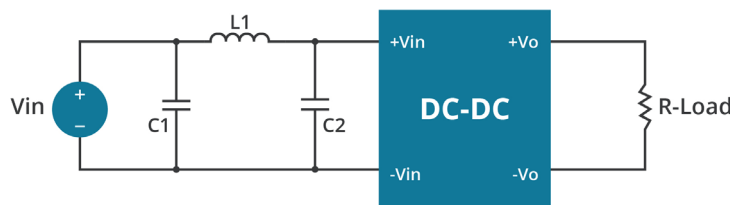

Table 3

EN55022 Class B Recommended External Circuit Components			
Input Voltage (Vdc)	C1 ¹	C2 ¹	L1
5	4.7 µF / 25 V	4.7 µF / 25 V	10 µH
12	4.7 µF / 25 V	4.7 µF / 25 V	10 µH
24	10 µF / 50 V	10 µF / 50 V	7.5 µH

Notes: 1. Ceramic Capacitor

REVISION HISTORY

rev.	description	date
1.0	initial release	07/26/2016
1.01	company logo updated	04/12/2021
1.02	derating curve, efficiency curves and circuit figures updated	07/01/2021

The revision history provided is for informational purposes only and is believed to be accurate.



CUI INC
a bel group

Headquarters
20050 SW 112th Ave.
Tualatin, OR 97062
800.275.4899

Fax 503.612.2383
cui.com
techsupport@cui.com

CUI offers a two (2) year limited warranty. Complete warranty information is listed on our website.

CUI reserves the right to make changes to the product at any time without notice. Information provided by CUI is believed to be accurate and reliable. However, no responsibility is assumed by CUI for its use, nor for any infringements of patents or other rights of third parties which may result from its use.

CUI products are not authorized or warranted for use as critical components in equipment that requires an extremely high level of reliability. A critical component is any component of a life support device or system whose failure to perform can be reasonably expected to cause the failure of the life support device or system, or to affect its safety or effectiveness.