



FEATURES

- Industry standard footprint
- 2:1 input range, 3W output power, minimum 3:1 input range with power derating to 2W
- Dual isolated output
- Short circuit protection
- Operating temperature range -40°C to 85°C
- Load and line regulation <1% on both outputs
- No heatsink required
- 1kVDC isolation 'Hi Pot Test'
- 5V, 12V & 24V inputs
- 12V & 15V outputs
- Internal SMD construction
- Fully encapsulated

DESCRIPTION

The NDTD series is a range of low profile DC-DC converters offering dual outputs over a 2:1 input voltage range. All parts deliver 3W output power up to 85°C without heatsinking. A flyback oscillator design with isolated feedback is used to give regulation over the full operating range of 25% to 100% of full load. It is strongly recommended that external capacitors be used on input and output to guarantee performance over full load and input voltage range (see application notes for guidance). The plastic case is rated to UL94V-0 and encapsulant to UL94V-1 and the connection pins are formed from a tin plated alloy 42 leadframe.

SELECTION GUIDE

Order code	Input voltage V (Nom.)	Rated output voltage V	Output current		Input current full load mA	Efficiency ² (Min.) %	Isolation capacitance pF	MTTF ³ kHrs	Recommended Alternative
			Min. Load ¹ mA	Full load mA					
			Recommended		In Production				
NDTD0512C	5	±12	±31	±125	764	76	36	1625	
NDTD1212C	12	±12	±31	±125	311	78	32	1650	
NDTD1215C	12	±15	±25	±100	310	78	36	1633	
NDTD2412C	24	±12	±31	±125	148	82	35	2075	
NDTD2415C	24	±15	±25	±100	146	82	41	2080	
			Discontinued						
NDTD0503C	5	±3.3	±113	±454	890	67	30	1644	Contact Murata
NDTD0505C	5	±5	±75	±300	804	72	31	1640	Contact Murata
NDTD0515C	5	±15	±25	±100	773	75	34	1609	Contact Murata
NDTD1203C	12	±3.3	±113	±454	343	73	30	1668	Contact Murata
NDTD1205C	12	±5	±75	±300	321	75	29	1665	Contact Murata
NDTD2403C	24	±3.3	±113	±454	170	73	30	1671	Contact Murata
NDTD2405C	24	±5	±75	±300	156	78	30	1675	Contact Murata
NDTD4803C	48	±3.3	±113	±454	86	72	30	1667	Contact Murata
NDTD4805C	48	±5	±75	±300	79	76	30	1669	Contact Murata
NDTD4812C	48	±12	±31	±125	76	80	35	2090	Contact Murata
NDTD4815C	48	±15	±25	±100	75	81	36	2045	Contact Murata

INPUT CHARACTERISTICS

Parameter	Conditions	Min.	Typ.	Max.	Units
Voltage range	5V input types	4.5	5	9	VDC
	12V input types	9	12	18	
	24V input types	18	24	36	
	48V input types	36	48	75	
Reflected ripple current ⁴	5V input types		40	90	mA p-p
	12V, 24V & 48V input types		30	40	

GENERAL CHARACTERISTICS

Parameter	Conditions	Min.	Typ.	Max.	Units
Switching frequency	100% to 25% load, VIN min to max	60		620	kHz

1. Please refer to minimum load application note section on page 4.
 2. Measured at full load with external input/output capacitors, refer to test circuit.
 3. Calculated using MIL-HDBK-217F with nominal input voltage at full load (ground benign) at 25°C.
 4. Please refer to reflected ripple current measurement circuit on page 3.
- All specifications typical at T_a=25°C, nominal input voltage and rated output current unless otherwise specified.



For full details go to
<https://www.murata.com/en-global/products/power/rohs>

OUTPUT CHARACTERISTICS						
Parameter	Conditions		Min.	Typ.	Max.	Units
Voltage set point accuracy	With external input/output capacitors	5V outputs		±2	±5	%
		12V & 15V outputs		±1	±3	
Line regulation	Low line to high line with external input/output capacitors			0.15	0.5	%
Load regulation	25% load to 100% load with external input/output capacitors with balanced load	5V outputs		0.5	1.0	%
		12V & 15V outputs		0.2	0.5	%
Ripple	BW = 20Hz to 300kHz with external input/output capacitors			15	40	mV rms
Ripple & noise	BW = DC to 20MHz with external input/output capacitors			90	150	mV p-p
Cross regulation	% voltage change on negative output when positive load varies from 12% to 50% of 3W rating, with negative load fixed at 50%	NDTD05XXC, NDTD1205C, NDTD2405C, NDTD4805C			5.0	%
		NDTD1212C, NDTD1215C, NDTD2412C, NDTD2415C, NDTD4812C, NDTD4815C		2.1	3.0	
Short circuit protection			Continuous			

ISOLATION CHARACTERISTICS						
Parameter	Conditions		Min.	Typ.	Max.	Units
Isolation voltage	Flash tested for 1 second		1000			VDC
Resistance	Viso=1KVDC		1			GΩ

TEMPERATURE CHARACTERISTICS						
Parameter	Conditions		Min.	Typ.	Max.	Units
Operation			-40		85	°C
Storage			-50		130	
Case temperature rise above ambient in still air	NDTD0505C, NDTD0512C, NDTD1205C, NDTD2405C, NDTD4805C			35		
	NDTD0515C, NDTD1212C, NDTD1215C, NDTD2412C, NDTD4812C, NDTD2415C, NDTD4815C			28		

ABSOLUTE MAXIMUM RATINGS	
Short-circuit protection	8 hours
Lead temperature 1.5mm from case for 10 seconds	260°C
Minimum output load for specification ¹	25% of rated output
Wave Solder	Wave Solder profile not to exceed the profile recommended in IEC 61760-1 Section 6.1.3. Please refer to application notes for further information.
Input voltage 5V types	10V
Input voltage 12V types	20V
Input voltage 24V types	40V
Input voltage 48V types	80V
Free air space	10mm Min. around component

TECHNICAL NOTES

ISOLATION VOLTAGE

'Hi Pot Test', 'Flash Tested', 'Withstand Voltage', 'Proof Voltage', 'Dielectric Withstand Voltage' & 'Isolation Test Voltage' are all terms that relate to the same thing, a test voltage, applied for a specified time, across a component designed to provide electrical isolation, to verify the integrity of that isolation.

Murata Power Solutions NDTD series of DC-DC converters are all 100% production tested at their stated isolation voltage. This is 1kVDC for 1 second.

A question commonly asked is, "What is the continuous voltage that can be applied across the part in normal operation?"

For a part holding no specific agency approvals, such as the NDTD series, both input and output should normally be maintained within SELV limits i.e. less than 42.4V peak, or 60VDC. The isolation test voltage represents a measure of immunity to transient voltages and the part should never be used as an element of a safety isolation system. The part could be expected to function correctly with several hundred volts offset applied continuously across the isolation barrier; but then the circuitry on both sides of the barrier must be regarded as operating at an unsafe voltage and further isolation/insulation systems must form a barrier between these circuits and any user-accessible circuitry according to safety standard requirements.

REPEATED HIGH-VOLTAGE ISOLATION TESTING

It is well known that repeated high-voltage isolation testing of a barrier component can actually degrade isolation capability, to a lesser or greater degree depending on materials, construction and environment. The NDTD series has an EI ferrite core, with no additional insulation between primary and secondary windings of enamelled wire. While parts can be expected to withstand several times the stated test voltage, the isolation capability does depend on the wire insulation. Any material, including this enamel (typically polyurethane) is susceptible to eventual chemical degradation when subject to very high applied voltages thus implying that the number of tests should be strictly limited. We therefore strongly advise against repeated high voltage isolation testing, but if it is absolutely required, that the voltage be reduced by 20% from specified test voltage.

This consideration equally applies to agency recognised parts rated for better than functional isolation where the wire enamel insulation is always supplemented by a further insulation system of physical spacing or barriers.

RoHS COMPLIANCE INFORMATION



This series is compatible with RoHS soldering systems with a peak wave solder temperature of 260°C for 10 seconds. Please refer to [application notes](#) for further information. The pin termination finish on this product series is Tin. The series is backward compatible with Sn/Pb soldering systems.

For further information, please visit www.murata.com/en-global/products/power/rohs

PART NUMBER STRUCTURE

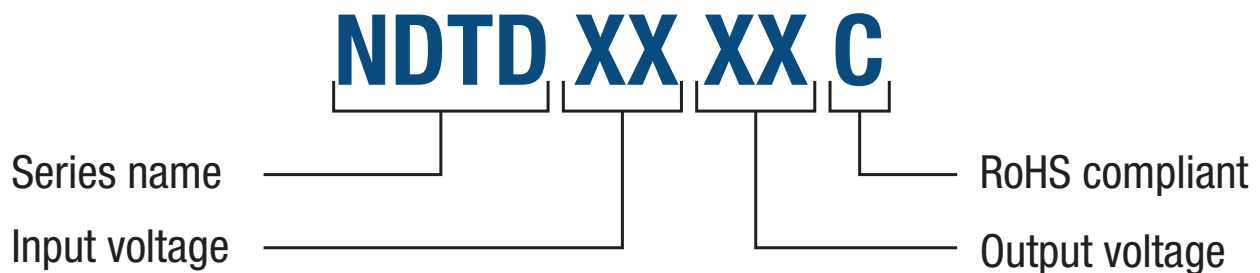

TERMINOLOGY

LINE REGULATION

The percentage change in output voltage between low input voltage and high input voltage, measured with fixed output load i.e. a 5V part with an output voltage of 5.05V @ high input voltage and 5.03V @ low input voltage would have a line regulation of 0.4%.

$$\text{Line regulation} = \frac{V_{\text{OUT}} (\text{Low Input V}) - V_{\text{OUT}} (\text{High Input V})}{V_{\text{OUT}} (\text{Nominal Input V})} \times 100\%$$

Where V_{OUT} (Nominal Input V) is 5V.

APPLICATION NOTES

Recommended Input & Output Capacitors

Although these converters will work without external capacitors, they are necessary in order to guarantee the full parametric performance over the full line and load range. All parts have been tested and characterised using the following values and test circuit.

Input Voltage	C _{IN}	Output Voltage	C _{OUT}
5V, 12V	100µF, 25V (0.25Ω at 100kHz)	5V	100µF, 25V (0.25Ω at 100kHz)
24V, 48V	10µF, 100V (1.5Ω at 100kHz)	12V, 15V	47µF, 25V (0.4Ω at 100kHz)

Test circuit

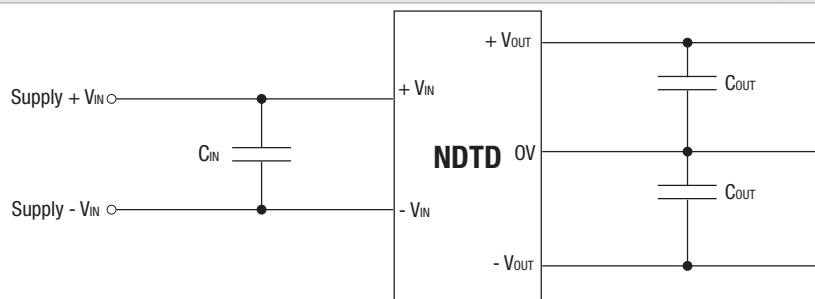

Reflected Ripple Current Measurement

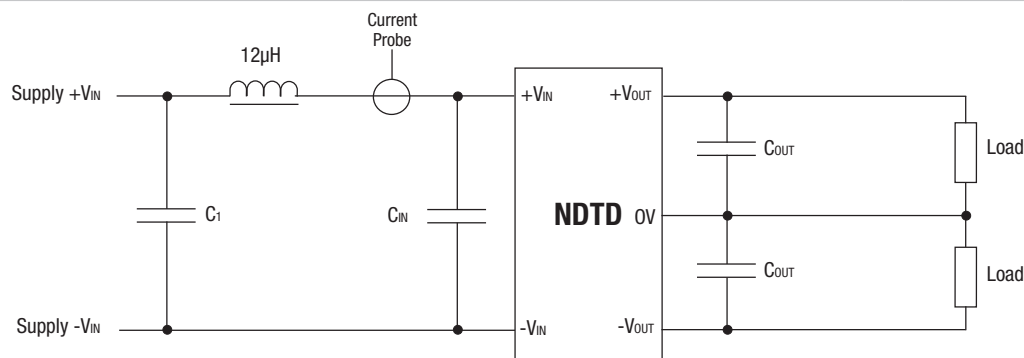

C₁ = 220µF, ESR < 0.1Ω at 100kHz

Cross Regulation

Load regulation is at its best when the positive and negative loads are balanced. When the loads are asymmetric, the negative output is not as tightly regulated as the positive output. To meet ripple specification a total minimum load of 25% full load is required, however, the NDTD can be used with much lighter loading at the expense of increased ripple. A small load is required on the negative output of 150mW to ensure the maximum negative output voltage is not exceeded.

APPLICATION NOTES (Continued)

Minimum Load

The minimum load for correct operation is 25% of the full rated load across the specified input voltage range. Lower loads may cause a significant increase in output ripple and may cause the output voltage to exceed its specification transiently during power-down when the input voltage also falls below its rated minimum.

The following graphs show the typical required minimum load required for stable operation in mA versus input voltage. Some variants are not included as they do not typically require a minimum load for stable operation: NDTD0512C, NDTD0515C, NDTD1212C and NDTD1215C.

NDTD0505C

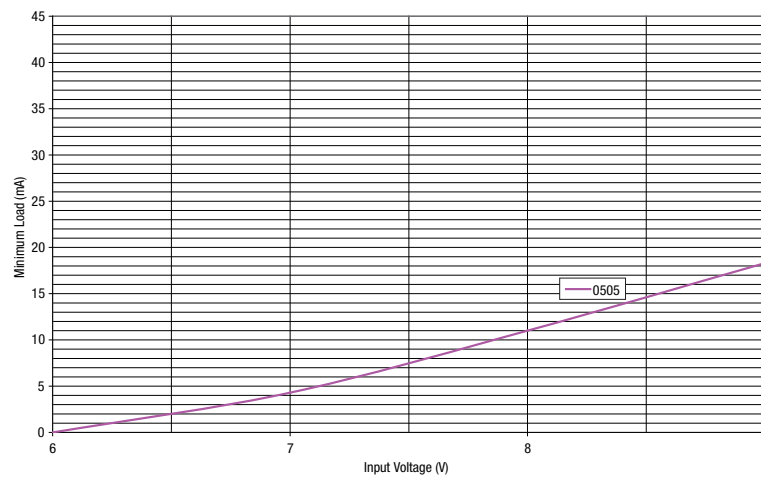

NDTD1205C

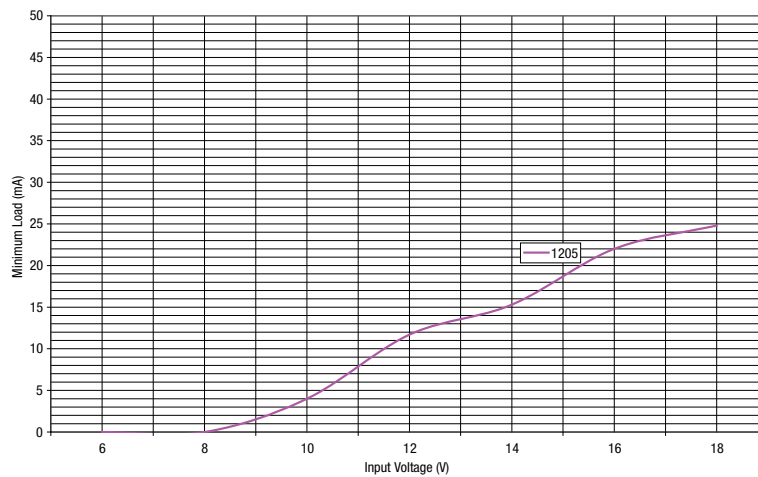

APPLICATION NOTES (Continued)

NDTD24XXC

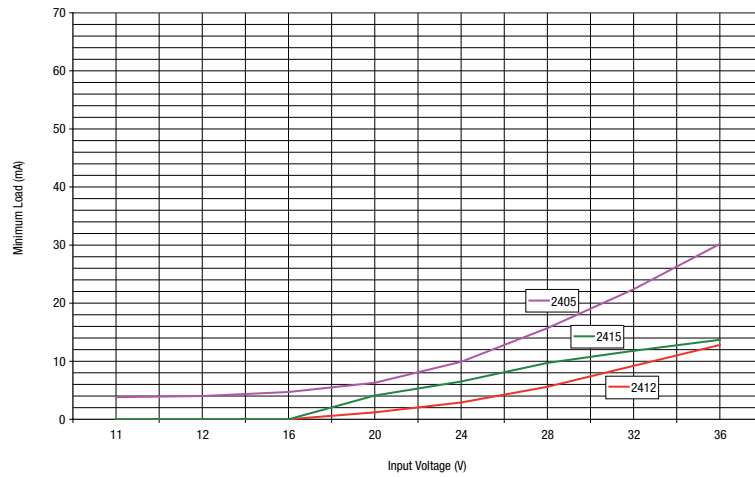

NDTD48XXC

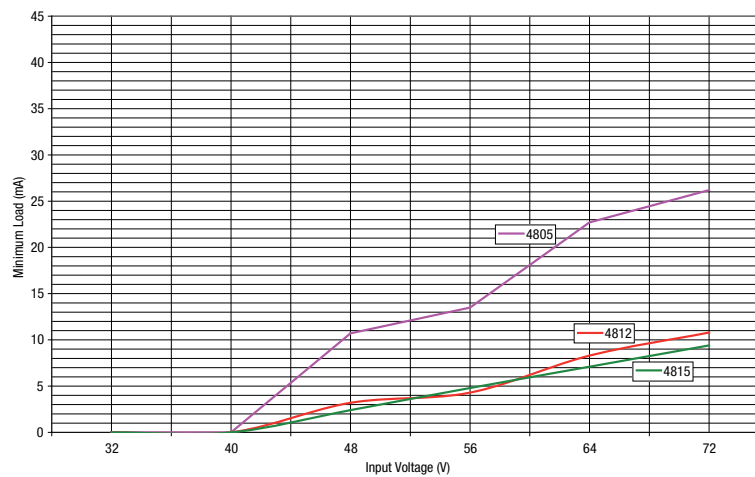

APPLICATION NOTES (Continued)

NDTD Power Derating

The NDTD series will operate from a wider input range than specified in the input characteristics datasheet table with output power derating.

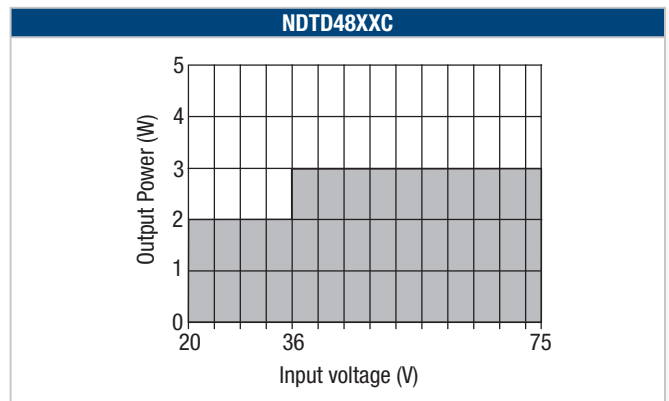
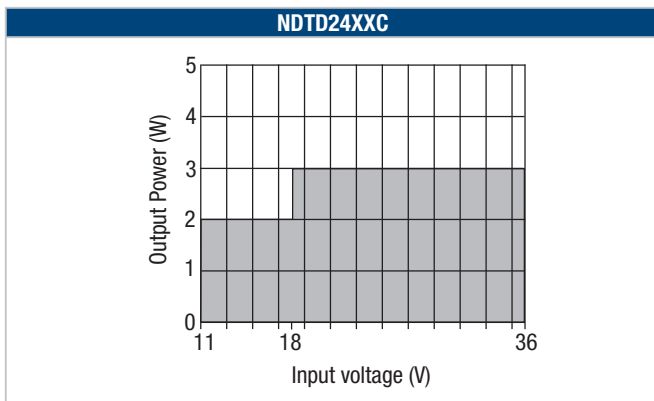
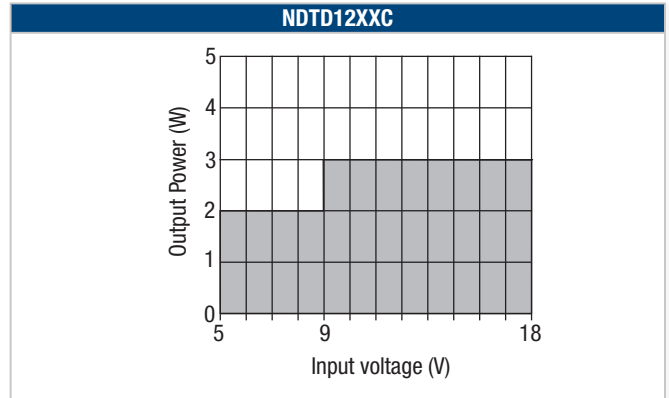
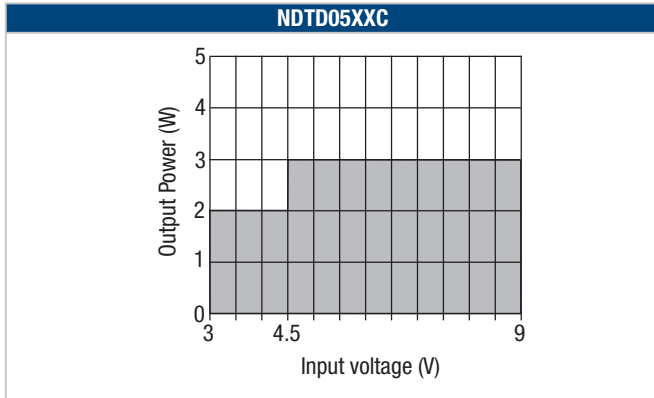

PACKAGE SPECIFICATIONS

MECHANICAL DIMENSIONS

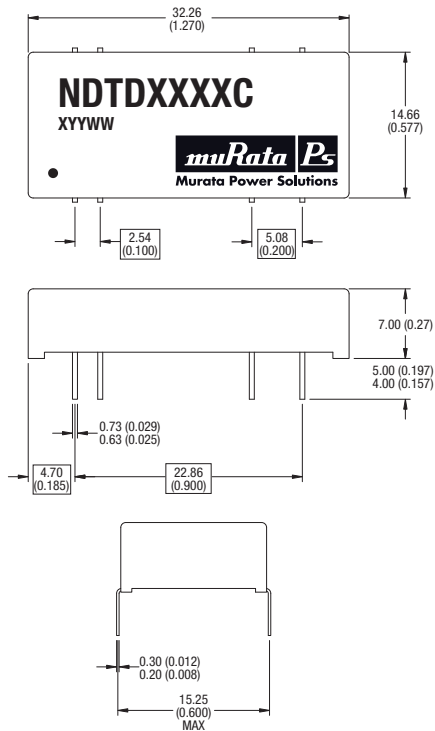

All dimensions in mm(inches) $\pm 0.25(0.010)^{\circ}$.
All pins on a 2.54(0.10") pitch and within $\pm 0.25(0.010)^{\circ}$ of true position.

Weight: 6.0g

PIN CONNECTIONS

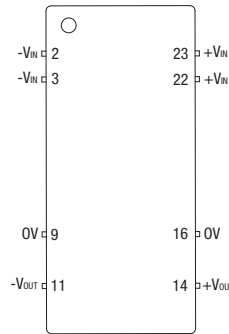

Pin	Function
2	-VIN
3	-VIN
9	OV
11	-VOUT
14	+VOUT
16	OV
22	+VIN
23	+VIN

RECOMMENDED FOOTPRINT DETAILS

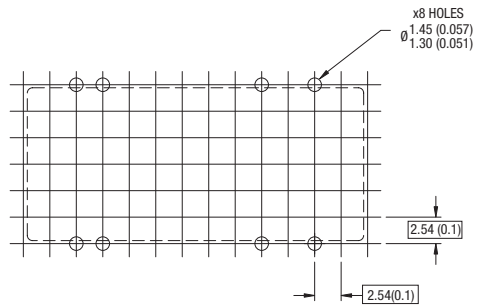

All dimensions in mm(inches) $\pm 0.25(0.010)^{\circ}$. All pins on a 2.54(0.10") pitch and within $\pm 0.25(0.010)^{\circ}$ of true position.

TUBE OUTLINE DIMENSIONS

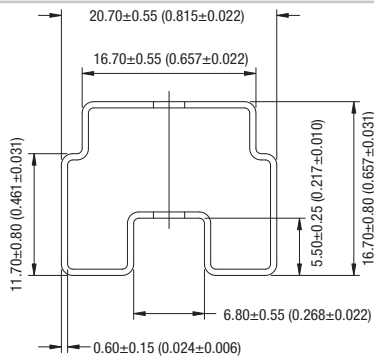

All dimensions in mm (inches) $\pm 0.5\text{mm} (0.020)^{\circ}$.
Tube length : 520mm $\pm 2\text{mm} (20.47 \pm 0.079)^{\circ}$.

Tube Quantity : 15

DISCLAIMER

Unless otherwise stated in the datasheet, all products are designed for standard commercial and industrial applications and NOT for safety-critical and/or life-critical applications.

Particularly for safety-critical and/or life-critical applications, i.e. applications that may directly endanger or cause the loss of life, inflict bodily harm and/or loss or severe damage to equipment/property, and severely harm the environment, a prior explicit written approval from Murata is strictly required. Any use of Murata standard products for any safety-critical, life-critical or any related applications without any prior explicit written approval from Murata shall be deemed unauthorised use.

These applications include but are not limited to:

- Aircraft equipment
- Aerospace equipment
- Undersea equipment
- Power plant control equipment
- Medical equipment
- Transportation equipment (automobiles, trains, ships, etc.)
- Traffic signal equipment
- Disaster prevention / crime prevention equipment
- Data Processing equipment

Murata makes no express or implied warranty, representation, or guarantee of suitability, fitness for any particular use/purpose and/or compatibility with any application or device of the buyer, nor does Murata assume any liability whatsoever arising out of unauthorised use of any Murata product for the application of the buyer. The suitability, fitness for any particular use/purpose and/or compatibility of Murata product with any application or device of the buyer remain to be the responsibility and liability of the buyer.

Buyer represents and agrees that it has all the necessary expertise to create and implement safeguards that anticipate dangerous consequences of failures, monitor failures and their consequences, lessen the likelihood of failures that might cause harm, and take appropriate remedial actions. Buyer will fully indemnify and hold Murata, its affiliated companies, and its representatives harmless against any damages arising out of unauthorised use of any Murata products in any safety-critical and/or life-critical applications.

Remark: Murata in this section refers to Murata Manufacturing Company and its affiliated companies worldwide including, but not limited to, Murata Power Solutions.



This product is subject to the following [operating requirements](https://www.murata.com/en-eu/products/power/requirements) and the [Life and Safety Critical Application Sales Policy](https://www.murata.com/en-eu/products/power/requirements):

Refer to: <https://www.murata.com/en-eu/products/power/requirements>

Murata Power Solutions (Milton Keynes) Ltd. makes no representation that the use of its products in the circuits described herein, or the use of other technical information contained herein, will not infringe upon existing or future patent rights. The descriptions contained herein do not imply the granting of licenses to make, use, or sell equipment constructed in accordance therewith. Specifications are subject to change without notice.

© 2023 Murata Power Solutions (Milton Keynes) Ltd.