

SERIES: PDS1-M | **DESCRIPTION:** DC-DC CONVERTER**FEATURES**

- 1 W isolated output
- smaller package
- single and dual unregulated outputs
- 1,500 Vdc isolation
- short circuit protection
- extended temperature range (-40~105°C)
- antistatic protection up to 8kV
- high efficiency at light load
- efficiency up to 82%



| MODEL | input voltage | | output voltage | output current | | output power | ripple and noise ² | efficiency |
|-------------------------------|---------------|-------------|----------------|----------------|----------|--------------|-------------------------------|------------|
| | typ (Vdc) | range (Vdc) | (Vdc) | min (mA) | max (mA) | max (W) | typ (mVp-p) | typ (%) |
| PDS1-S3-S3-M ^{3,4} | 3.3 | 2.97~3.63 | 3.3 | 30 | 303 | 1 | 60 | 69 |
| PDS1-S3-S5-M ^{1,3,4} | 3.3 | 2.97~3.63 | 5 | 20 | 200 | 1 | 60 | 74 |
| PDS1-S3-D5-M ^{3,4} | 3.3 | 2.97~3.63 | ±5 | ±10 | ±100 | 1 | 60 | 76 |
| PDS1-S3-D12-M ^{3,4} | 3.3 | 2.97~3.63 | ±12 | ±5 | ±42 | 1 | 60 | 77 |
| PDS1-S3-D15-M ^{3,4} | 3.3 | 2.97~3.63 | ±15 | ±3 | ±33 | 1 | 60 | 78 |
| PDS1-S5-S3-M ^{1,3} | 5 | 4.5~5.5 | 3.3 | 30 | 303 | 1 | 60 | 72 |
| PDS1-S5-S5-M ¹ | 5 | 4.5~5.5 | 5 | 20 | 200 | 1 | 60 | 80 |
| PDS1-S5-S9-M ^{3,4} | 5 | 4.5~5.5 | 9 | 12 | 111 | 1 | 60 | 80 |
| PDS1-S5-S12-M ^{1,3} | 5 | 4.5~5.5 | 12 | 9 | 84 | 1 | 60 | 80 |
| PDS1-S5-S15-M ^{1,3} | 5 | 4.5~5.5 | 15 | 7 | 67 | 1 | 60 | 80 |
| PDS1-S5-S24-M ^{1,3} | 5 | 4.5~5.5 | 24 | 4 | 42 | 1 | 60 | 80 |
| PDS1-S5-D5-M ³ | 5 | 4.5~5.5 | ±5 | ±10 | ±100 | 1 | 60 | 80 |
| PDS1-S5-D9-M ^{3,4} | 5 | 4.5~5.5 | ±9 | ±6 | ±56 | 1 | 60 | 80 |
| PDS1-S5-D12-M ^{3,4} | 5 | 4.5~5.5 | ±12 | ±5 | ±42 | 1 | 60 | 79 |
| PDS1-S5-D15-M ³ | 5 | 4.5~5.5 | ±15 | ±3 | ±33 | 1 | 60 | 81 |
| PDS1-S5-D24-M ^{3,4} | 5 | 4.5~5.5 | ±24 | ±2 | ±21 | 1 | 60 | 81 |
| PDS1-S12-S3-M ^{1,3} | 12 | 10.8~13.2 | 3.3 | 30 | 303 | 1 | 60 | 72 |
| PDS1-S12-S5-M ^{1,3} | 12 | 10.8~13.2 | 5 | 20 | 200 | 1 | 60 | 71 |
| PDS1-S12-S9-M ^{1,3} | 12 | 10.8~13.2 | 9 | 12 | 111 | 1 | 60 | 80 |
| PDS1-S12-S12-M ^{1,3} | 12 | 10.8~13.2 | 12 | 9 | 84 | 1 | 60 | 80 |
| PDS1-S12-S15-M ^{1,3} | 12 | 10.8~13.2 | 15 | 7 | 67 | 1 | 60 | 80 |
| PDS1-S12-D5-M ^{3,4} | 12 | 10.8~13.2 | ±5 | ±10 | ±100 | 1 | 60 | 80 |
| PDS1-S12-D9-M ^{3,4} | 12 | 10.8~13.2 | ±9 | ±6 | ±56 | 1 | 60 | 80 |
| PDS1-S12-D12-M ^{3,4} | 12 | 10.8~13.2 | ±12 | ±5 | ±42 | 1 | 60 | 73 |
| PDS1-S12-D15-M ^{3,4} | 12 | 10.8~13.2 | ±15 | ±3 | ±33 | 1 | 60 | 81 |
| PDS1-S12-D24-M ^{3,4} | 12 | 10.8~13.2 | ±24 | ±2 | ±21 | 1 | 60 | 81 |
| PDS1-S15-S15-M ³ | 15 | 13.5~16.5 | 15 | 7 | 67 | 1 | 60 | 80 |

| MODEL (CONTINUED) | input voltage | | output voltage | output current | | output power | ripple and noise ² | efficiency |
|--------------------------------|---------------|-------------|----------------|----------------|----------|--------------|-------------------------------|------------|
| | typ (Vdc) | range (Vdc) | (Vdc) | min (mA) | max (mA) | max (W) | typ (mVp-p) | typ (%) |
| PDS1-S24-S5-M ¹ | 24 | 21.6~26.4 | 5 | 20 | 200 | 1 | 60 | 73 |
| PDS1-S24-S9-M ^{1,3,4} | 24 | 21.6~26.4 | 9 | 12 | 111 | 1 | 60 | 80 |
| PDS1-S24-S12-M | 24 | 21.6~26.4 | 12 | 9 | 84 | 1 | 60 | 80 |
| PDS1-S24-S15-M ¹ | 24 | 21.6~26.4 | 15 | 7 | 67 | 1 | 60 | 72 |
| PDS1-S24-S24-M ^{1,3} | 24 | 21.6~26.4 | 24 | 4 | 42 | 1 | 60 | 80 |
| PDS1-S24-D5-M ^{3,4} | 24 | 21.6~26.4 | ±5 | ±10 | ±100 | 1 | 60 | 70 |
| PDS1-S24-D9-M ³ | 24 | 21.6~26.4 | ±9 | ±6 | ±56 | 1 | 60 | 80 |
| PDS1-S24-D12-M ^{3,4} | 24 | 21.6~26.4 | ±12 | ±5 | ±42 | 1 | 60 | 72 |
| PDS1-S24-D15-M ³ | 24 | 21.6~26.4 | ±15 | ±3 | ±33 | 1 | 60 | 71 |
| PDS1-S24-D24-M ^{3,4} | 24 | 21.6~26.4 | ±24 | ±2 | ±21 | 1 | 60 | 80 |

- Notes:
1. UL approved
 2. Ripple and noise are measured at 20 MHz BW by "parallel cable" method with 1 µF ceramic and 10 µF electrolytic capacitors on the output.
 3. Standard option discontinued.
 4. Tape and Reel option discontinued.

PART NUMBER KEY

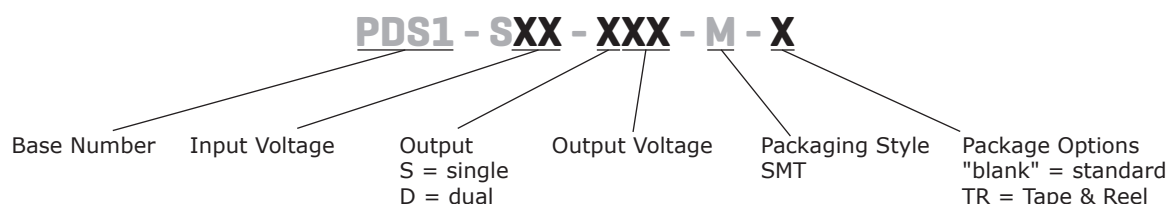

INPUT

| parameter | conditions/description | min | typ | max | units |
|-------------------------|-------------------------|------|-----|------|-------|
| operating input voltage | 3.3 Vdc input models | 2.97 | 3.3 | 3.63 | Vdc |
| | 5 Vdc input models | 4.5 | 5 | 5.5 | Vdc |
| | 12 Vdc input models | 10.8 | 12 | 13.2 | Vdc |
| | 15 Vdc input models | 13.5 | 15 | 16.5 | Vdc |
| | 24 Vdc input models | 21.6 | 24 | 26.4 | Vdc |
| surge voltage | for maximum of 1 second | | | | |
| | 3.3 Vdc input models | -0.7 | | 5 | Vdc |
| | 5 Vdc input models | -0.7 | | 9 | Vdc |
| | 12 Vdc input models | -0.7 | | 18 | Vdc |
| | 15 Vdc input models | -0.7 | | 21 | Vdc |
| | 24 Vdc input models | -0.7 | | 30 | Vdc |
| filter | capacitance filter | | | | |

OUTPUT

| parameter | conditions/description | min | typ | max | units |
|-------------------------|-------------------------------------|-----|-----|-------|-------|
| line regulation | for Vin change of 1% | | | | |
| | 3.3 Vdc output models | | | ±1.5 | % |
| | all other models | | | ±1.2 | % |
| load regulation | measured from 10% load to full load | | | | |
| | 3.3 Vdc output models | | 18 | | % |
| | 5 Vdc output models | | 12 | | % |
| | 9 Vdc output models | | 8 | | % |
| | 12 Vdc output models | | 7 | | % |
| | 15 Vdc output models | | 6 | | % |
| | 24 Vdc output models | | 5 | | % |
| voltage accuracy | see tolerance envelope curve | | | | |
| switching frequency | 100% load, nominal input voltage | | 100 | | kHz |
| temperature coefficient | 100% load | | | ±0.03 | %/°C |

PROTECTIONS

| parameter | conditions/description | min | typ | max | units |
|---------------------------------------|--------------------------------------|-----|-----|-----|-------|
| short circuit protection ¹ | 3 & 24 Vdc input models | | | 1 | s |
| | PDS1-S5-S12-M, PDS1-S5-D24-M | | | 1 | s |
| | all other models: automatic recovery | | | | |

Note: 1. The supply voltage must be discontinued at the end of the short circuit duration

SAFETY AND COMPLIANCE

| parameter | conditions/description | min | typ | max | units |
|-------------------------------|--|-----------|-----|-----|-------|
| isolation voltage | input to output for 1 minute at 1 mA max. | 1,500 | | | Vdc |
| isolation resistance | input to output at 500 Vdc | 1,000 | | | MΩ |
| isolation capacitance | input to output at 100 kHz/0.1 V | | 20 | | pF |
| safety approvals ² | certified to 60950-1: UL designed to meet 62368: EN | | | | |
| conducted emissions | CISPR32/EN55032, class B (external circuit required, see Figure 1) | | | | |
| radiated emissions | CISPR32/EN55032, class B (external circuit required, see Figure 1) | | | | |
| ESD | IEC/EN 61000-4-2, class B, contact ±8kV (single output models) IEC/EN 61000-4-2, class B, contact ±6kV (dual output models) | | | | |
| MTBF | as per MIL-HDBK-217F @ 25 °C | 3,500,000 | | | hours |
| RoHS | 2011/65/EU | | | | |

Note: 2. See specific models noted on pages 1 & 2

ENVIRONMENTAL

| parameter | conditions/description | min | typ | max | units |
|-----------------------|------------------------|-----|-----|-----|-------|
| operating temperature | see derating curve | -40 | | 105 | °C |
| storage temperature | | -55 | | 125 | °C |
| storage humidity | non-condensing | | | 95 | % |
| temperature rise | at full load, Ta=25°C | | 25 | | °C |

SOLDERABILITY

| parameter | conditions/description | min | typ | max | units |
|------------------|---------------------------------|-----|-----|-----|-------|
| hand soldering | 1.5 mm from case for 10 seconds | | | 300 | °C |
| reflow soldering | see reflow soldering profile | | | 245 | °C |

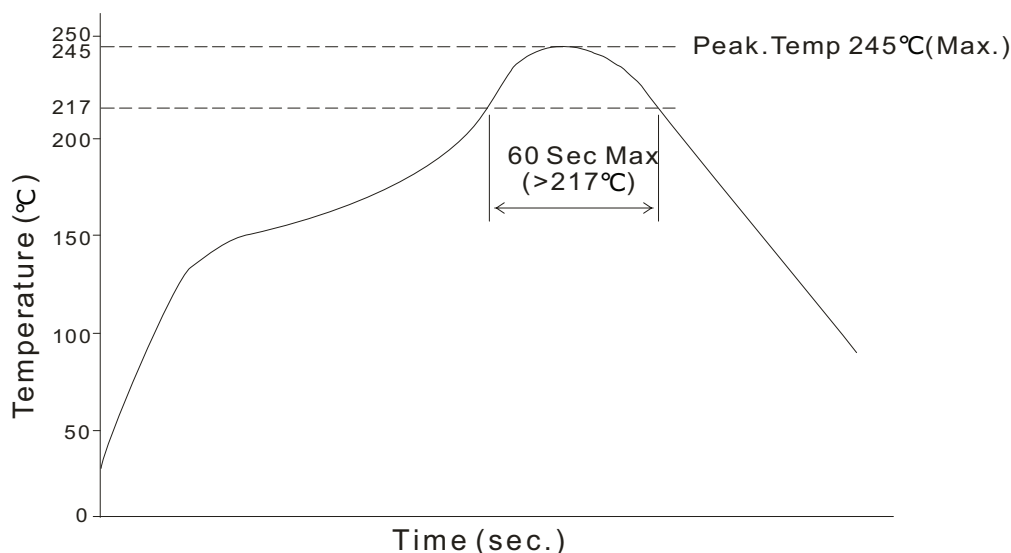

MECHANICAL

| parameter | conditions/description | min | typ | max | units |
|---------------|---|-----|------------|-----|----------|
| dimensions | single output models: 12.7 x 8.30 x 7.25 dual output models: 15.24 x 8.30 x 7.25 | | | | mm mm |
| case material | epoxy resin (UL94-V0) | | | | |
| weight | single output models dual output models | | 1.6 2.0 | | g g |

MECHANICAL DRAWING

SINGLE OUTPUT MODELS

units: mm[inch]

tolerance: $\pm 0.25[\pm 0.010]$

pin section tolerance: $\pm 0.10[\pm 0.004]$

| PIN CONNECTIONS | |
|-----------------|----------|
| PIN | Function |
| 1 | GND |
| 2 | Vin |
| 4 | 0V |
| 5 | +Vo |
| 8 | NC |

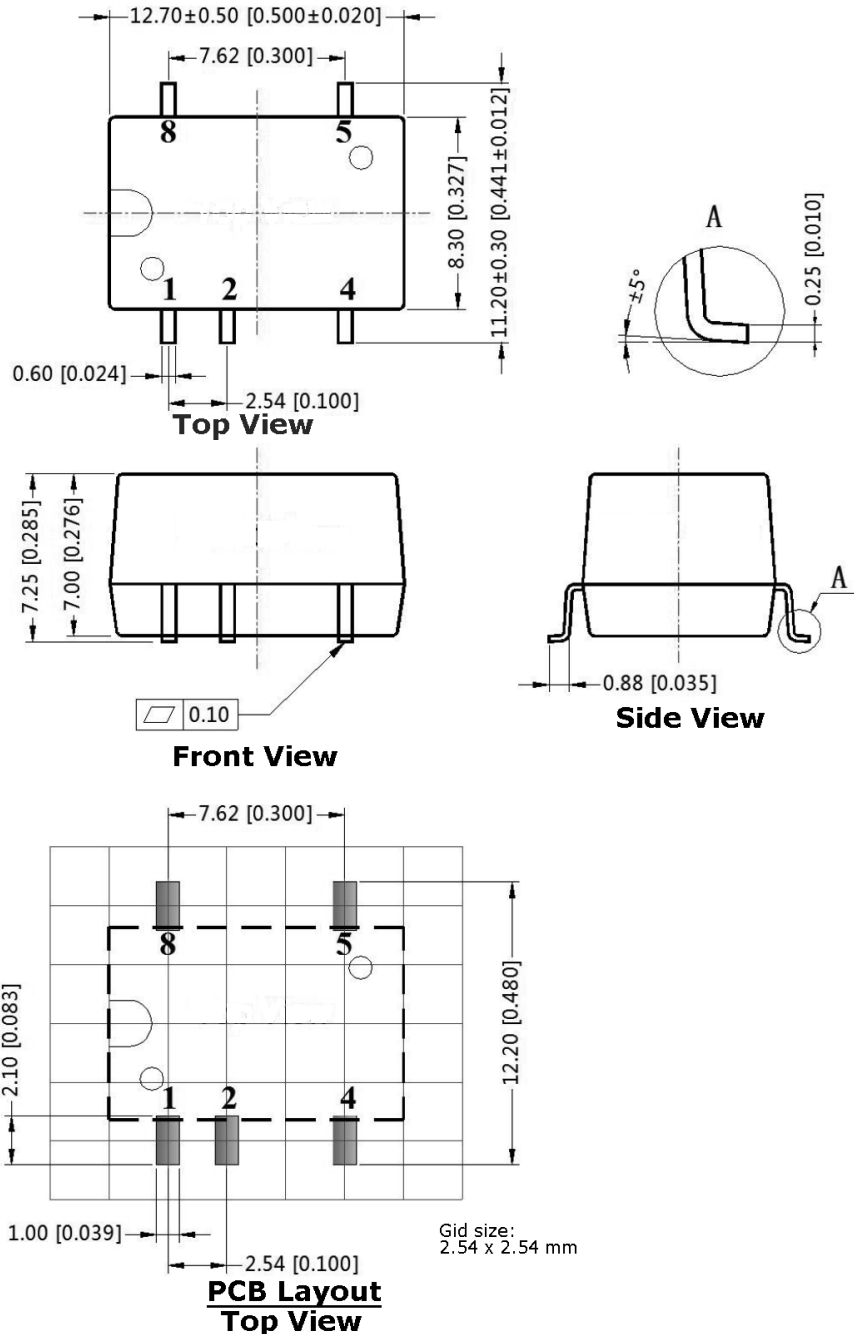

MECHANICAL DRAWING (CONTINUED)

DUAL OUTPUT MODELS

units: mm[inch]

tolerance: $\pm 0.25[\pm 0.010]$

pin section tolerance: $\pm 0.10[\pm 0.004]$

| PIN CONNECTIONS | |
|-----------------|----------|
| PIN | Function |
| 1 | GND |
| 2 | Vin |
| 4 | 0V |
| 5 | -Vo |
| 7 | +Vo |
| 10 | NC |

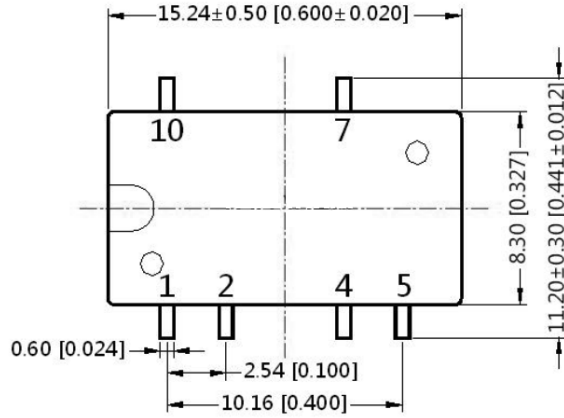

Top View

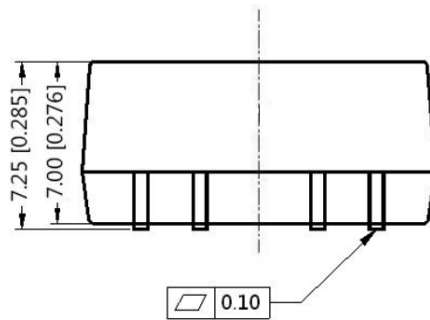
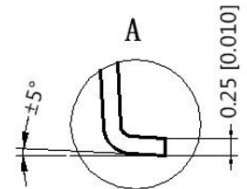

Front View

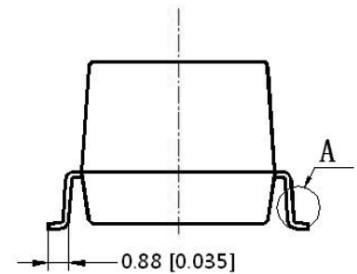

Side View

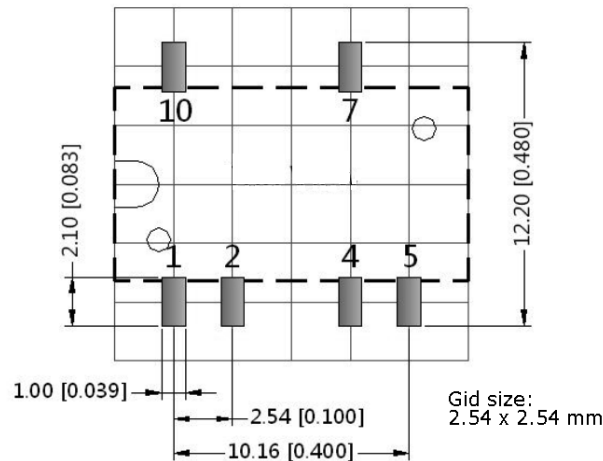

**PCB Layout
Top View**

DERATING CURVES

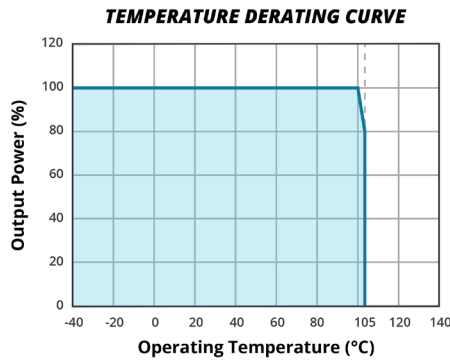
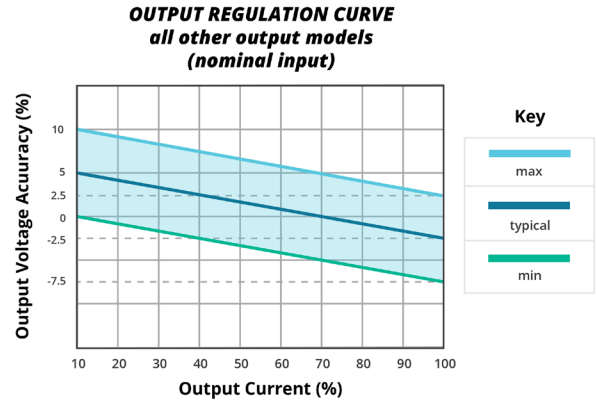
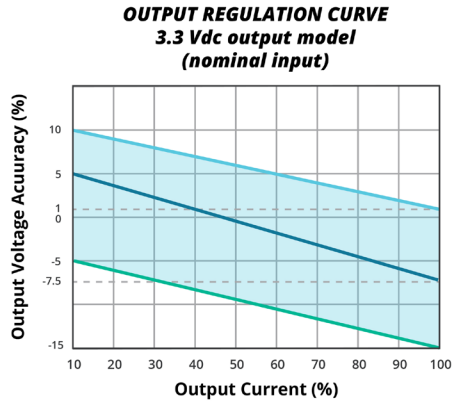

EMC RECOMMENDED CIRCUIT

Figure 1

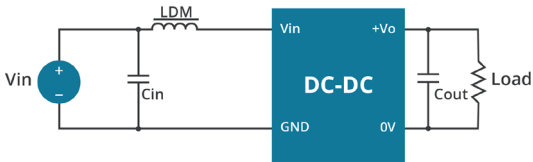

Single Outputs

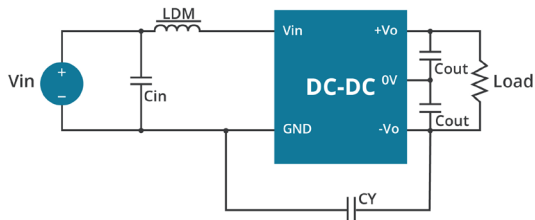

Dual Outputs

Table 1

| Recommended external circuit components | | | | |
|---|-----------|-------|--------|---------|
| Vout (dc) | Cin | LDM | Cout | CY |
| 3.3 | 4.7µF/50V | 6.8µH | 10µF | - |
| 5 | 4.7µF/50V | 6.8µH | 10µF | - |
| 9 | 4.7µF/50V | 6.8µH | 4.7µF | - |
| 12 | 4.7µF/50V | 6.8µH | 2.2µF | - |
| 15 | 4.7µF/50V | 6.8µH | 1µF | - |
| 24 | 4.7µF/50V | 6.8µH | 0.47µF | - |
| ±5 | 4.7µF/50V | 6.8µH | 4.7µF | - |
| ±9 | 4.7µF/50V | 6.8µH | 2.2µF | - |
| ±12 | 4.7µF/50V | 6.8µH | 1µF | - |
| ±15 | 4.7µF/50V | 6.8µH | 1µF | 1nF/2kV |
| ±24 | 4.7µF/50V | 6.8µH | 0.47µF | 1nF/2kV |

Note: 1. See Cout values in Tables 1 and 2.
2. 24 Vdc output models require CY also.

APPLICATION NOTES

1. Output load requirement

To ensure this module can operate efficiently and reliably, the minimum output load may not be less than 10% of the full load during operation. If the actual output power is low, connect a resistor at the output end in parallel to increase the load.

2. Overload Protection

Under normal operating conditions, the output circuit of this product has no protection against overload. The simplest method to add this is to add a circuit breaker to the circuit.

3. Recommended circuit

If you want to further decrease the input/output ripple, you can increase the capacitance accordingly or choose capacitors with low ESR (see Figure 2 & Table 1). However, the capacitance of the output filter capacitor must be appropriate. If the capacitance is too high, a startup problem might arise. For every channel of the output, to ensure safe and reliable operation, the maximum capacitance must be less than the maximum capacitive load (see Table 2). It's not recommended to connect any external capacitors in applications with less than 0.5 watt output.

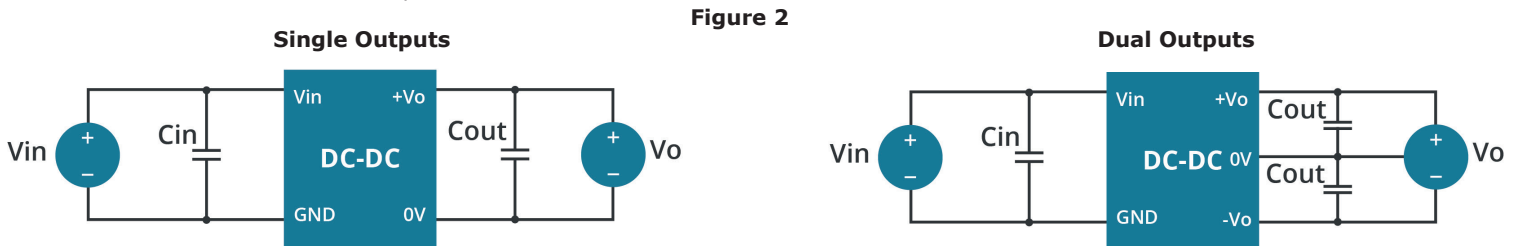

Figure 2

Table 2

| Single Vout (Vdc) | Max. Capacitive Load (μF) | Dual Vout (Vdc) | Max. Capacitive Load ¹ (μF) |
|-------------------|---------------------------|-----------------|--|
| 3.3 | 220 | - | - |
| 5 | 220 | ±5 | 100 |
| 9 | 220 | ±9 | 100 |
| 12 | 220 | ±12 | 100 |
| 15 | 220 | ±15 | 100 |
| 24 | 220 | ±24 | 100 |

Note: 1. For each output.

4. Output Voltage Regulation and Over-voltage Protection Circuit

The device for output voltage regulation, over-voltage and over-current protection is a linear regulator and a capacitor filtering network with overheat protection which can be connected to the input or output end in series (see Figure 3). The recommended capacitance of its filter capacitor (see Table 1 & 2), and the linear regulator is based on the actual voltage and current required.

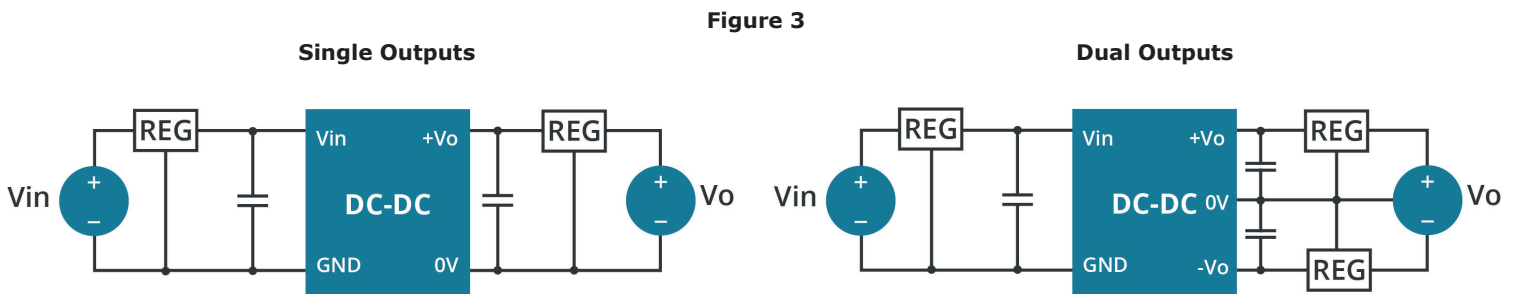

Figure 3

Note: 1. Operation under minimum load will not damage the converter; however, they may not meet all specifications listed.

2. Max. capacitive load tested at input voltage range and full load.

3. It is recommended to use either ceramic capacitors or electrolytic capacitors on the input and the output. Using tantalum capacitors may increase the risk of failure.

4. All specifications measured at: Ta=25°C, humidity<75%, nominal input voltage and rated output load, unless otherwise specified.

REVISION HISTORY

| rev. | description | date |
|------|--|------------|
| 1.0 | initial release | 03/19/2013 |
| 1.01 | added PDS1-S24-S12-M model | 06/11/2013 |
| 1.02 | added dual output models | 02/17/2014 |
| 1.03 | added models PDS1-S3-S3-M, PDS1-S3-S5-M, PDS1-S5-S3-M, and PDS1-S12-S3-M | 04/18/2014 |
| 1.04 | added UL approval to some models, updated spec | 10/03/2014 |
| 1.05 | updated datasheet | 07/03/2018 |
| 1.06 | safeties updated in features and safety line | 01/18/2021 |
| 1.07 | emc circuits updated | 03/14/2021 |
| 1.08 | derating curves & circuit figures updated | 07/06/2021 |
| 1.09 | efficiency updated for PDS1-S12-S5-M, PDS1-S24-S5-M, PDS1-S24-S15-M, PDS1-S12-D12-M, PDS1-S24-D5-M, PDS1-S24-D12-M & PDS1-S24-D15-M | 08/09/2022 |
| 1.10 | CE removed | 10/27/2022 |
| 1.11 | discontinued models PDS1-S12-D12-M, PDS1-S12-D15-M, PDS1-S12-D24-M, PDS1-S12-D24-M-TR, PDS1-S12-D5-M, PDS1-S12-D9-M, PDS1-S12-D9-M-TR | 07/06/2023 |
| 1.12 | discontinued models PDS1-S3-D12-M-TR, PDS1-S3-D15-M-TR, PDS1-S3-D5-M-TR, PDS1-S5-D12-M, PDS1-S5-D24-M-TR & PDS1-S5-D9-M-TR | 09/28/2023 |
| 1.13 | discontinued models PDS1-S12-S12-M, PDS1-S12-S15-M, PDS1-S12-S3-M, PDS1-S12-S5-M, PDS1-S12-S9-M, PDS1-S15-S15-M, PDS1-S24-D12-M, PDS1-S24-D12-M-TR, PDS1-S24-D15-M, PDS1-S24-D5-M, PDS1-S24-D5-M-TR, PDS1-S24-D9-M, PDS1-S24-S24-M, PDS1-S24-S9-M, PDS1-S24-S9-M-TR, PDS1-S3-D12-M, PDS1-S3-D15-M, PDS1-S3-D5-M, PDS1-S3-S3-M, PDS1-S3-S5-M, PDS1-S5-D12-M-TR, PDS1-S5-D15-M, PDS1-S5-D24-M, PDS1-S5-D5-M, PDS1-S5-D9-M, PDS1-S5-S12-M, PDS1-S5-S15-M, PDS1-S5-S24-M, PDS1-S5-S3-M, PDS1-S5-S9-M & PDS1-S5-S9-M-TR | 01/15/2024 |

The revision history provided is for informational purposes only and is believed to be accurate.



CUI INC

a bel group

Headquarters

20050 SW 112th Ave.
Tualatin, OR 97062
800.275.4899

Fax 503.612.2383
cui.com
techsupport@cui.com

CUI offers a two (2) year limited warranty. Complete warranty information is listed on our website.

CUI reserves the right to make changes to the product at any time without notice. Information provided by CUI is believed to be accurate and reliable. However, no responsibility is assumed by CUI for its use, nor for any infringements of patents or other rights of third parties which may result from its use.

CUI products are not authorized or warranted for use as critical components in equipment that requires an extremely high level of reliability. A critical component is any component of a life support device or system whose failure to perform can be reasonably expected to cause the failure of the life support device or system, or to affect its safety or effectiveness.