

Series: [SSW/TSW](#) .100" (2.54 mm) .025" Square Post Socket And Terminal Strip  
[SMH/TSW](#) .100" (2.54 mm) .025" SMT Horizontal Socket And Terminal Strip

**SSW Series** – Socket, Vertical Through-hole Orientation

**SMH Series** – Socket, SMT Horizontal Orientation

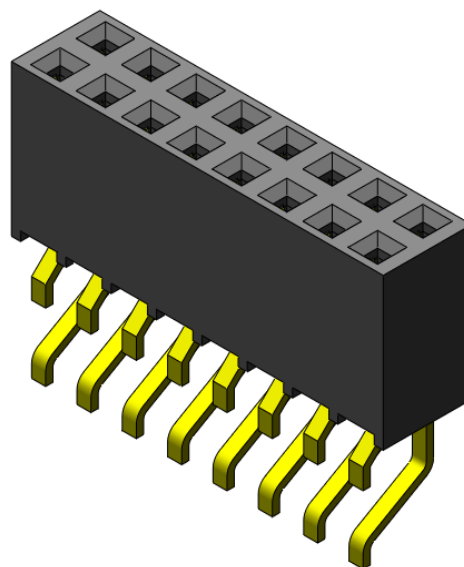
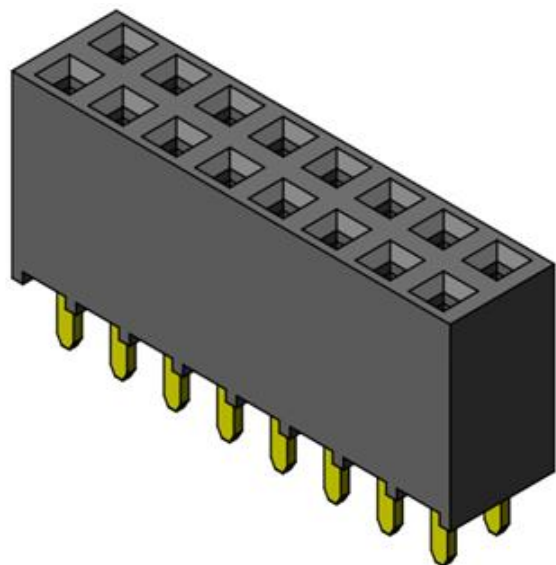

**TSW Series** – Terminal, Vertical Through-hole Orientation

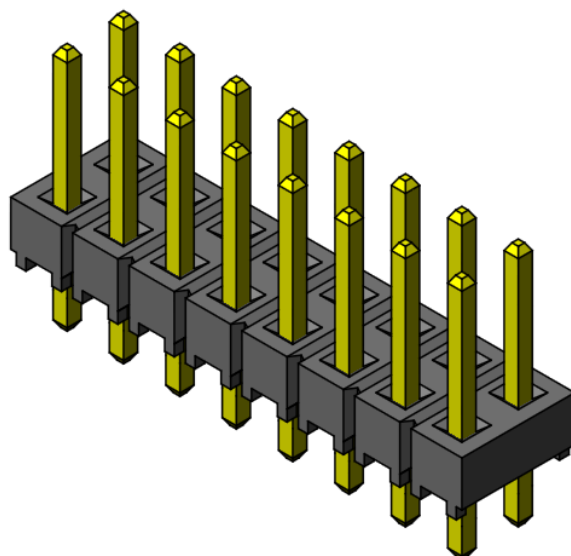

**Other configurations available for:**

Surface Mount, Right-Angle, Notch, Locking Lead, Polarized, and Single Row, Double Row, Triple Row applications

See [www.samtec.com](http://www.samtec.com) for more information.

**Series:** [SSW/TSW](#) .100" (2.54 mm) .025" Square Post Socket And Terminal Strip  
[SMH/TSW](#) .100" (2.54 mm) .025" SMT Horizontal Socket And Terminal Strip

## 1.0 SCOPE

**1.1** This specification covers performance, testing and quality requirements for Samtec's SSW/TSW Series .100"(2.54 mm) .025" square post socket and terminal strip and SMH/TSW series SMT horizontal socket and terminal strip. All information contained in this specification is for a through-hole socket / through-hole terminal mated configuration unless otherwise noted.

## 2.0 DETAILED INFORMATION

**2.1** Product prints, footprints, catalog pages, test reports and other specific, detailed information can be found at <http://www.samtec.com/?SSW>, <https://www.samtec.com/products/smh> and <http://www.samtec.com/?TSW>

## 3.0 TESTING

**3.1 Current Rating:** 4.7 A (One pin powered per row)

**3.2 Voltage Rating:** 465 VAC

**3.3 Operating Temperature Range:** Gold plating: -55°C to +125°C; Tin plating: -55°C to +105°C

**3.4 Operating Humidity Range:** up to 95% (Per EIA-364-31)

**3.5 Electrical:**

ITEM	TEST CONDITION	REQUIREMENT	STATUS
Withstanding Voltage	EIA-364-20 (No Flashover, Sparkover, or Breakdown)	1410 VAC	Pass
Insulation Resistance	EIA-364-21 (5000 MΩ minimum)	5,000 MΩ	Pass
Contact Resistance (LLCR)	EIA-364-23	Δ 15 mΩ maximum (Samtec defined)/ No damage	Pass

**3.6 Mechanical:**

ITEM	TEST CONDITION	REQUIREMENT	STATUS
Durability	EIA-364-09C	1000 cycles	Pass
Random Vibration	EIA-364-28 Condition V, Letter B 7.56 G 'RMS', 50 to 2000 Hz, 2 hours per axis, 3 axis total, PSD 0.04	Visual Inspection: No Damage LLCR: Δ 15 mΩ maximum	Pass
Mechanical Shock	EIA-364-27 100 G, 6 milliseconds, sawtooth wave, 11.3 fps, 3 shocks/direction, 3 axis (18 total shocks)	Visual Inspection: No Damage LLCR: Δ 15 mΩ maximum	Pass
Normal Force	EIA-364-04	30 grams minimum for Gold interface	Pass

Series: **SSW/TSW** .100" (2.54 mm) .025" Square Post Socket And Terminal Strip  
**SMH/TSW** .100" (2.54 mm) .025" SMT Horizontal Socket And Terminal Strip

**3.7 Environmental:**

ITEM	TEST CONDITION	REQUIREMENT	STATUS
Thermal Shock	EIA-364-32 Thermal Cycles: 100 (30 minute dwell) Hot Temp: 85°C Cold Temp: -55°C Hot/Cold Transition: Immediate	Visual Inspection: No Damage LLCR: $\Delta$ 15 m $\Omega$ DWV: 1410 VAC IR: >10,000 M $\Omega$	Pass
Thermal Aging (Temp Life)	EIA-364-17 Test Condition 4 @ 105°C Condition B for 250 hours	Visual Inspection: No Damage LLCR: $\Delta$ 15 m $\Omega$ DWV: 1410 VAC IR: >10,000 M $\Omega$	Pass
Cyclic Humidity	EIA-364-31 Test Temp: 25°C to 65°C Relative Humidity: 90 to 95% Test Duration: 240 hours	Visual Inspection: No Damage LLCR: $\Delta$ 15 m $\Omega$ DWV: 1410 VAC IR: >10,000 M $\Omega$	Pass
Gas Tight	EIA-364-36 Gas Exposure: Nitric Acid Vapor Duration: 60 min. Drying Temp.: 50°C +/- 3°C Measurements: Within 1 hour of Exposure	LLCR: $\Delta$ 15 m $\Omega$	Pass

**4.0 PROCESSING RECOMMENDATIONS**
**4.1 Mating Alignment Requirements:**

4.1.1 Allowable initial linear misalignment in applications where at least one half of the interface is free to float.

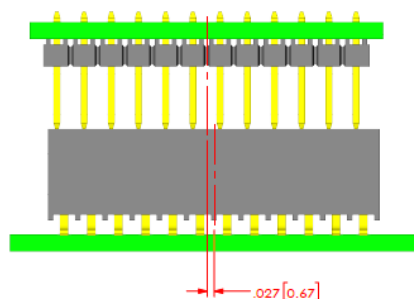

INITIAL X AXIS LINEAR MISALIGNMENT

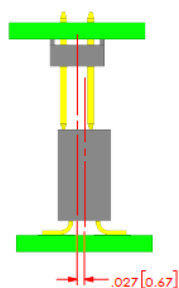

INITIAL Y AXIS LINEAR MISALIGNMENT

NON APPLICABLE

INITIAL Z AXIS LINEAR MISALIGNMENT

Series: **SSW/TSW** .100" (2.54 mm) .025" Square Post Socket And Terminal Strip  
**SMH/TSW** .100" (2.54 mm) .025" SMT Horizontal Socket And Terminal Strip

4.1.2 Allowable final linear misalignment in applications where at least one half of the interface is free to float.

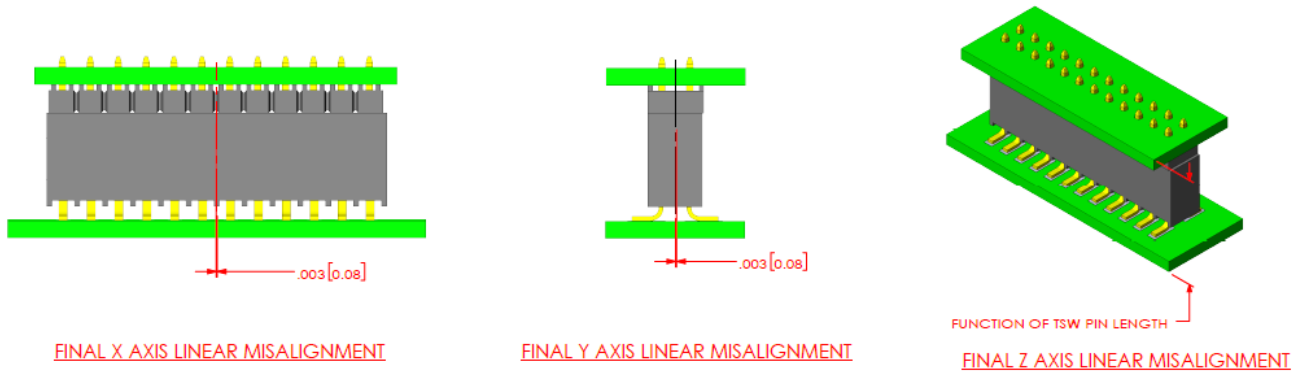

4.2 Mating Angle Requirements:

4.2.1 Allowable initial angular misalignment

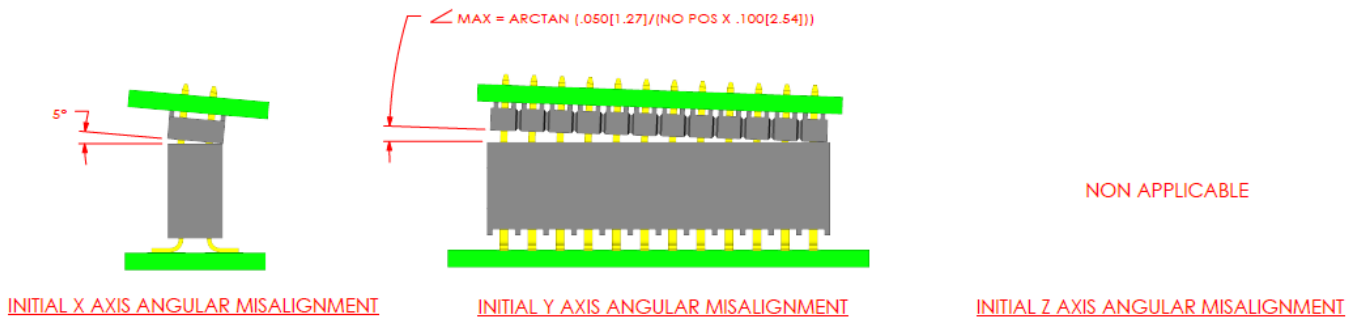

4.2.2 Allowable final angular misalignment

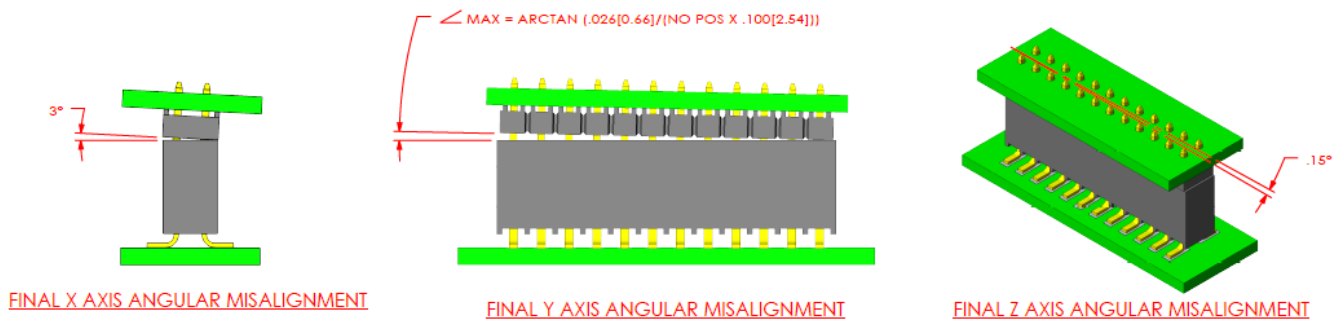

Series: [SSW/TSW](#) .100" (2.54 mm) .025" Square Post Socket And Terminal Strip  
[SMH/TSW](#) .100" (2.54 mm) .025" SMT Horizontal Socket And Terminal Strip

**4.3** Due to variances in equipment, solder pastes and applications (board design, component density, etc.), Samtec does not specify a recommended reflow profile for our connectors. The processing parameters provided by the solder paste manufacturer should be employed and can usually be found on their website.

All of Samtec's surface mount components are lead free reflow compatible and compliant with the profile parameters detailed in IPC/JEDEC J-STD-020 which requires that components be capable of withstanding a peak temperature of 260°C as well as 30 seconds above 255°C.

**Samtec Recommended Temperature Profile Ranges (SMT)**

**Sn-Pb Eutectic Assembly**

Preheat/Soak (100°C-150°C)	Max Ramp Up Rate	Reflow Time (above 183°C)	Peak Temp	Time within 5°C of 235°C	Max Ramp Down Rate	Time 25°C to Peak Temp
60-120 sec.	3°C/s max.	40-150 sec.	235°C	20 sec. max.	6°C/s max.	6 min. max.

**Pb-Free Assembly**

Preheat/Soak (150°C-200°C)	Max Ramp Up Rate	Reflow Time (above 217°C)	Peak Temp	Time within 5°C of 260°C	Max Ramp Down Rate	Time 25°C to Peak Temp
60-120 sec.	3°C/s max.	40-150 sec.	260°C	30 sec. max.	6°C/s max.	8 min. max.

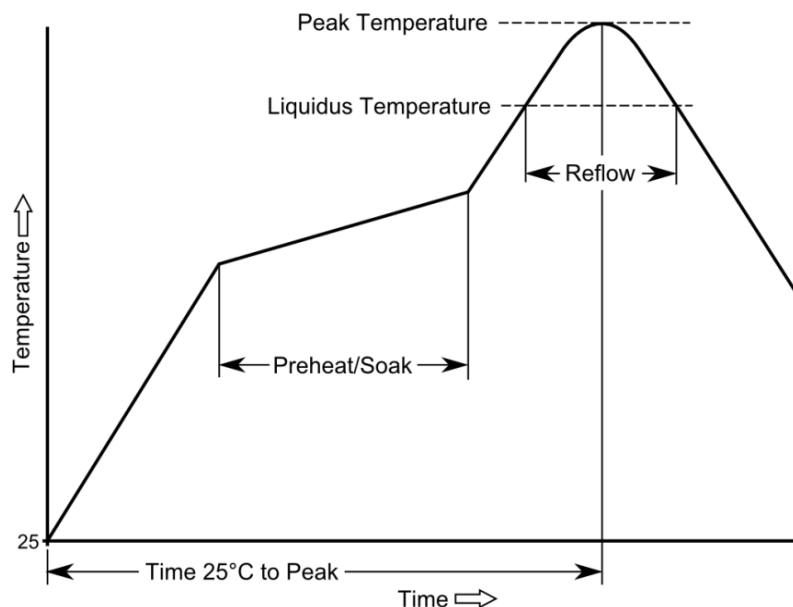

**4.3.1**

These guidelines should not be considered design requirements for all applications.

Samtec recommends testing interconnects on your boards in your process to guarantee optimum results.

**4.4 Maximum Reflow Passes:** The parts can withstand three reflow passes at a maximum component temperature of 260°C.

**Series:** [SSW/TSW](#) .100" (2.54 mm) .025" Square Post Socket And Terminal Strip  
[SMH/TSW](#) .100" (2.54 mm) .025" SMT Horizontal Socket And Terminal Strip

**4.5 Stencil Thickness:** The stencil thickness is .006" (0.15 mm).

**4.6 Placement:** Machine placement of the parts is strongly recommended.

**Note:** If the Locking Clip option (-LC) is used, manual placement will be required if the force needed to fully seat the connector exceeds the limit of the machine placement equipment. For more information, please visit the Processing page on our website or contact Samtec's Interconnect Processing Group at [IPG@samtec.com](mailto:IPG@samtec.com).

**4.7 Reflow Environment:** Samtec recommends the use of a low level oxygen environment (typically achieved through Nitrogen gas infusion) in the reflow process to improve solderability.

**4.8 Hardware:** Board-to-board standoffs are recommended to provide a robust mechanical connection. Samtec offers two different types:

**4.8.1 Traditional Standoffs (SO)** – Rigid design to statically support board-to-board applications. See options here: [SO - Board Stacking Standoff](#)

**4.8.2 Jack Screw Standoffs (JSO)** – Serve same function as traditional standoffs but unique, nested construction facilitates the mating and unmating process. This is especially helpful for multiple connector applications where the mating and unmating forces increase with the number of connectors used. See options here: [JSO - Jack Screw Standoffs](#)

**4.9 Cleaning:** Samtec, Inc. has verified that our connectors may be cleaned in accordance with the solvents and conditions designated in the EIA-364-11 standard.

## 5.0 ADDITIONAL RESOURCES

**5.1** For additional mechanical testing or product information, contact our Customer Engineering Support Group at [CES@samtec.com](mailto:CES@samtec.com)

**5.2** For additional information on high speed performance testing, contact our Signal Integrity Group at [SIG@samtec.com](mailto:SIG@samtec.com)

**5.3** For additional processing information, contact our Interconnect Processing Group at [IPG@samtec.com](mailto:IPG@samtec.com).

**5.4** For RoHS, REACH or other environmental compliance information, contact our Product Environmental Compliance Group at [PEC@samtec.com](mailto:PEC@samtec.com)

### USE OF PRODUCT SPECIFICATION SHEET

This Product Specification Sheet ("PSS") is a brief summary of information related to the Product identified. As a summary, it should only be used for the limited purpose of considering the purchase/use of Product. For specific, detailed information, including but not limited to testing and Product footprint, refer to Section 2.0 of this document and the links there provided to test reports and prints. This PSS is the property of Samtec, Inc. ("Samtec") and contains proprietary information of Samtec, our various licensors, or both. Samtec does not grant express or implied rights or license under any patent, copyright, trademark or other proprietary rights and the use of the PSS for building, reverse engineering or replication is strictly prohibited. By using the PSS, the user agrees to not infringe, directly or indirectly, upon any intellectual property rights of Samtec and acknowledges that Samtec, our various licensors, or both own all intellectual property therein. The PSS is presented "AS IS". While Samtec makes every effort to present excellent information, the PSS is only provided as a guideline and does not, therefore, warrant it is without error or defect or that the PSS contains all necessary and/or relevant information about the Product. The user agrees that all access and use of the PSS is at its own risk. **NO WARRANTIES EXPRESSED OR IMPLIED, INCLUDING ANY WARRANTY OF MERCHANTABILITY, FITNESS FOR A PARTICULAR PURPOSE OR OF ANY KIND WHATSOEVER ARE PROVIDED.**