

5-104505-6 ✓ ACTIVE

AMPMODU | AMPMODU MTE

TE Internal #: 5-104505-6

Pin Contact, Gold, 300 VAC, 26 – 22 AWG Wire Size, .12 – .4 mm²

Wire Size, 254 – 642 CMA Wire Size, Crimp, Phosphor Bronze,

Signal, AMPMODU MTE

[View on TE.com >](#)



Connectors > Contacts > Connector Contacts

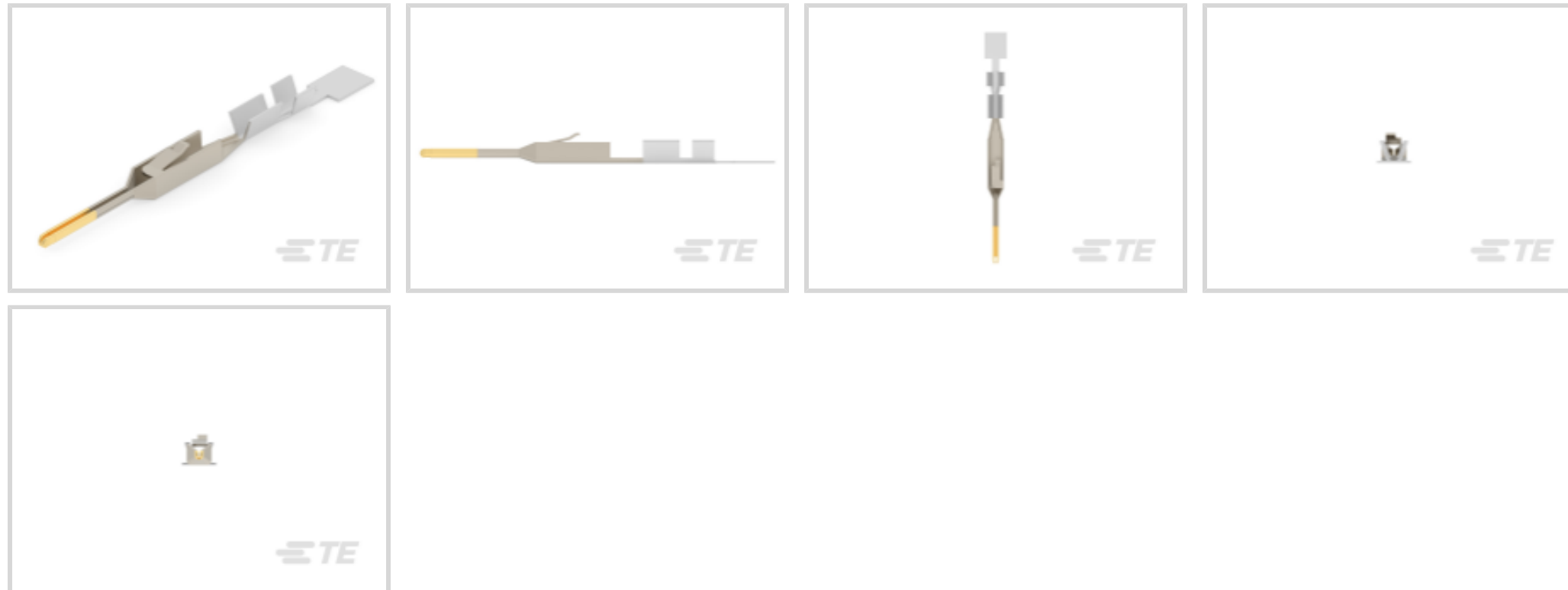

Contact Type: **Pin**

Contact Mating Area Plating Material: **Gold**

Wire Contact Termination Area Plating Material: **Tin**

Operating Voltage: **300 VAC**

Wire Size: **26 – 22 AWG**

Features

Product Type Features

Applied Pressure	Standard
------------------	----------

Electrical Characteristics

Termination Resistance	12 mΩ
Insulation Resistance	5000 MΩ
Dielectric Withstanding Voltage (Max)	750 V
Operating Voltage	300 VAC

Contact Features

Mating Square Post Dimension	.64 mm[.025 in]
Wire Contact Termination Area Plating Thickness	1.27 – 2.54 μm[50 – 100 μin]
Wire Contact Termination Area Plating Material Finish	Matte
Contact Underplating Material	Nickel
Contact Type	Pin
Contact Mating Area Plating Material	Gold
Wire Contact Termination Area Plating Material	Tin



Contact Base Material	Phosphor Bronze
-----------------------	-----------------

Contact Current Rating (Max)	3 A
------------------------------	-----

Termination Features

Termination Method to Wire & Cable	Crimp
------------------------------------	-------

Product Terminates To	Wire & Cable
-----------------------	--------------

Mechanical Attachment

Wire Insulation Support	With
-------------------------	------

Dimensions

Compatible Insulation Diameter Range	.91 – 1.37 mm [.035 – .054 in]
--------------------------------------	--------------------------------

Wire Size	254 – 642 CMA
-----------	---------------

Usage Conditions

Operating Temperature Range	-65 – 105 °C [-85 – 221 °F]
-----------------------------	-----------------------------

Operation/Application

Circuit Application	Signal
---------------------	--------

Industry Standards

Compatible With Approved Standards Products	CSA LR7189, UL E28476
---	-----------------------

Packaging Features

Packaging Quantity	12500
--------------------	-------

Packaging Method	Strip
------------------	-------

Product Compliance

[For compliance documentation, visit the product page on TE.com>](#)

EU RoHS Directive 2011/65/EU	Compliant
------------------------------	-----------

EU ELV Directive 2000/53/EC	Compliant
-----------------------------	-----------

China RoHS 2 Directive MIIT Order No 32, 2016	No Restricted Materials Above Threshold
---	---

EU REACH Regulation (EC) No. 1907/2006	Current ECHA Candidate List: JUNE 2023 (235) Candidate List Declared Against: JUNE 2023 (235) Does not contain REACH SVHC
--	---

Halogen Content	Low Halogen - Br, Cl, F, I < 900 ppm per homogenous material. Also BFR/CFR/PVC Free
-----------------	---

Solder Process Capability	Not applicable for solder process capability
---------------------------	--

Product Compliance Disclaimer

This information is provided based on reasonable inquiry of our suppliers and represents our current actual knowledge based on the information they provided. This information is subject to change. The part numbers that TE has identified as EU RoHS compliant have a maximum concentration of 0.1% by weight in homogenous materials for lead, hexavalent chromium, mercury, PBB, PBDE, DBP, BBP, DEHP, DIBP, and 0.01% for cadmium, or qualify for an exemption to these limits as defined in the Annexes of Directive 2011/65/EU (RoHS2). Finished electrical and electronic equipment products will be CE marked as required by Directive 2011/65/EU. Components may not be CE marked. Additionally, the part numbers that TE has identified as EU ELV compliant have a maximum concentration of 0.1% by weight in homogenous materials for lead, hexavalent chromium, and mercury, and 0.01% for cadmium, or qualify for an exemption to these limits as defined in the Annexes of Directive 2000/53/EC (ELV). Regarding the REACH Regulation, the information TE provides on SVHC in articles for this part number is based on the latest European Chemicals Agency (ECHA) 'Guidance on requirements for substances in articles' posted at this URL: <https://echa.europa.eu/guidance-documents/guidance-on-reach>

Compatible Parts



TE Part # 91531-1
CCII MTE AMPMODU MTE PIN REC
26-22 ASSY



TE Part # 843477-1
TOOL, EXTRACTION RESET



TE Part # 2151236-1
OCEAN_2.0_Applicator-S-042F0550



TE Part # 2151236-2
OCEAN_2.0_Applicator-S-042F0550



TE Part # 2305570-1
Strip Terminal Cutter-Side Feed-No
Crimp



TE Part # 7-2151236-1
OCEAN_2.0_Applicator-S-042F0550



TE Part # 7-2151236-2
OCEAN_2.0_Applicator-S-042F0550



TE Part # 7-2151236-7
OCEAN_2.0_SPARE_PART_KIT-
042F0550

Also in the Series | AMPMODU MTE



Connector Caps & Covers(40)



Connector Contacts(32)

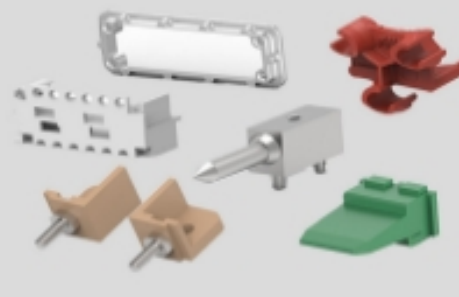

Connector Hardware(1)



Insertion & Extraction Tools(1)



PCB Headers & Receptacles(763)

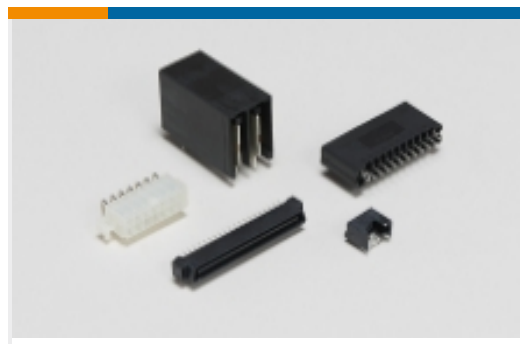

Standard Rectangular Connectors(2)



Wire-to-Board Connector Assemblies & Housings(585)

Customers Also Bought



TE Part #2-31887-1
PIDG R 22-16 COMM 22-18 MIL 10



TE Part #1-2176230-3
3522 8R2 5% 3W

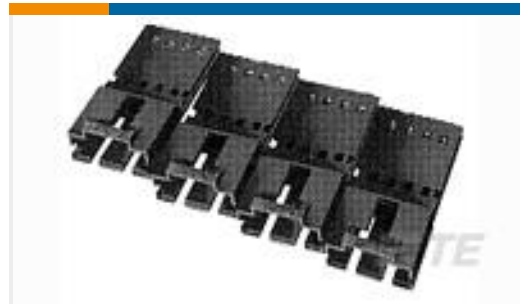

TE Part #103653-5
06 MTE SHRD PIN HSG SR LATCH



TE Part #103653-1
02 MTE SHRD PIN HSG SR LATCH

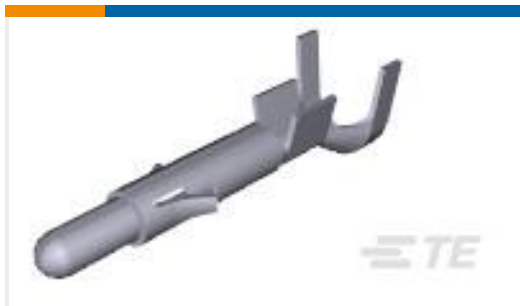

TE Part #350538-7
UMNL PIN 20-14 AU/NI/BR



TE Part #104257-4
05 MTE RCPT HSG SR LATCH .100



TE Part #1734300-1
SHIELD FINGER 3025-Z1-T



TE Part #CV4186-000
RNF-100-1/4-BK-SP-SH



TE Part #2-1423164-2
7022PD=RLY,STD,OFF,2P,125VDC,5

Documents

Product Drawings

[MTE PIN 22-26 AWG PLTD](#)

English

CAD Files

Customer View Model

[ENG_CVM_CVM_5-104505-6_V.2d_dxf.zip](#)

English

[3D PDF](#)



3D

Customer View Model

[ENG_CVM_CVM_5-104505-6_V.3d_igs.zip](#)

English

Customer View Model

[ENG_CVM_CVM_5-104505-6_V.3d_stp.zip](#)

English

By downloading the CAD file I accept and agree to the [Terms and Conditions](#) of use.

Datasheets & Catalog Pages

[AMPMODU_INTERCONNECTION_SYSTEM_SECTION5_CONT](#)

English

[AMPMODU MTE INTERCONNECT SYSTEM](#)

English

Product Specifications

[Application Specification](#)

English