

144617-1 ✓ ACTIVE



Standard Power Timer

TE Internal #: 144617-1

Automotive Terminals, Receptacle, Mating Tab Width 6.3 mm [.25 in], Tab Thickness .8 mm [.031 in], 17 – 12 AWG Wire Size, Standard Power Timer

[View on TE.com >](#)

Terminals & Splices > Automotive Terminals > TIMER, RECEPTACLE AND TAB

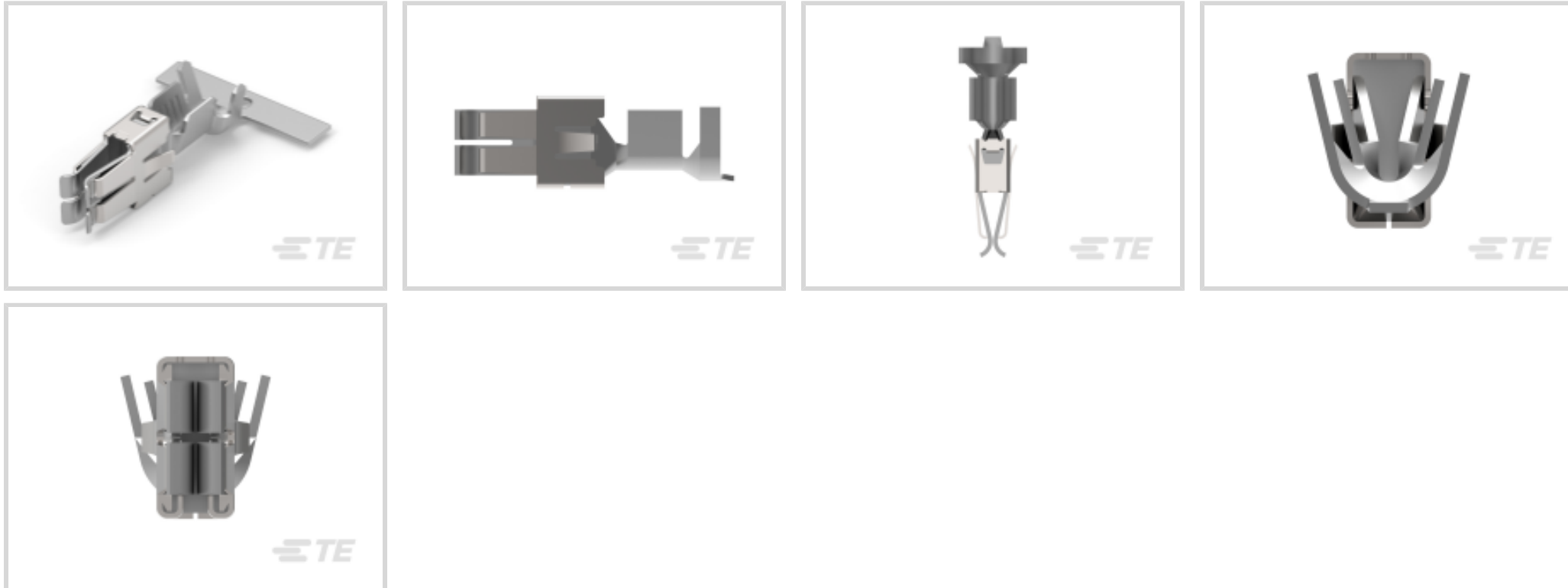

Terminal Type: **Receptacle**

Mating Tab Width: **6.3 mm [.25 in]**

Mating Tab Thickness: **.8 mm [.031 in]**

Terminal Transmits: **0 – 24 A (Low Power)**

Wire Size: **17 – 12 AWG**

[All TIMER, RECEPTACLE AND TAB \(330\)](#)

Features

Product Type Features

Receptacle Style	180°
Sealable	No
Primary Locking Feature	Locking Lance

Contact Features

Contact Size	6.3mm
Contact Fabrication	Stamped & Formed
Wire Contact Termination Area Plating Material	Tin
Typical Current Rating	18 A
Crimp Type	F-Crimp
Terminal Type	Receptacle
Mating Tab Width	6.3 mm [.25 in]
Mating Tab Thickness	.8 mm [.031 in]
Interface Plating	Tin (Sn)



Termination Features

Termination Method to Wire & Cable	Crimp
Product Terminates To	Wire

Dimensions

Compatible Insulation Diameter Range	4.4 mm[.173 in]
Wire Size	1 – 3 mm ²
Wire Size Search	12 AWG, 13 AWG, 14 AWG, 15 AWG, 16 AWG, 17 AWG
Tab Length	19.5 mm[.77 in]

Usage Conditions

Insulation Option	Uninsulated
Operating Temperature (Max)	100 °C[212 °F]
Operating Temperature Range	-40 – 100 °C[-40 – 212 °F]

Operation/Application

Compatible With Wire Base Material	Copper
------------------------------------	--------

Packaging Features

Packaging Quantity	2000
Packaging Method	Reel

Other

Terminal Transmits	0 – 24 A (Low Power)
--------------------	----------------------

Product Compliance

[For compliance documentation, visit the product page on TE.com>](#)

EU RoHS Directive 2011/65/EU	Compliant
EU ELV Directive 2000/53/EC	Compliant
China RoHS 2 Directive MIIT Order No 32, 2016	No Restricted Materials Above Threshold
EU REACH Regulation (EC) No. 1907/2006	Current ECHA Candidate List: JUNE 2023 (235) Candidate List Declared Against: JUNE 2023 (235) Does not contain REACH SVHC
Halogen Content	Low Halogen - Br, Cl, F, I < 900 ppm per homogenous material. Also BFR/CFR/PVC Free







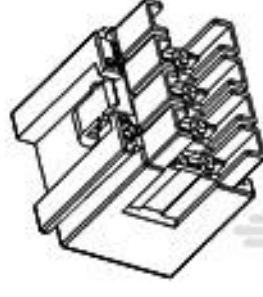

Solder Process Capability

Not applicable for solder process capability

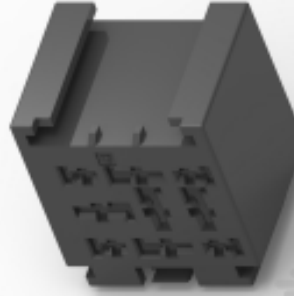
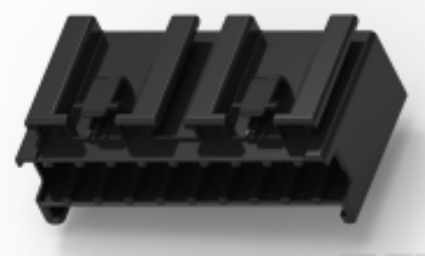
Product Compliance Disclaimer

This information is provided based on reasonable inquiry of our suppliers and represents our current actual knowledge based on the information they provided. This information is subject to change. The part numbers that TE has identified as EU RoHS compliant have a maximum concentration of 0.1% by weight in homogenous materials for lead, hexavalent chromium, mercury, PBB, PBDE, DBP, BBP, DEHP, DIBP, and 0.01% for cadmium, or qualify for an exemption to these limits as defined in the Annexes of Directive 2011/65/EU (RoHS2). Finished electrical and electronic equipment products will be CE marked as required by Directive 2011/65/EU. Components may not be CE marked. Additionally, the part numbers that TE has identified as EU ELV compliant have a maximum concentration of 0.1% by weight in homogenous materials for lead, hexavalent chromium, and mercury, and 0.01% for cadmium, or qualify for an exemption to these limits as defined in the Annexes of Directive 2000/53/EC (ELV). Regarding the REACH Regulation, the information TE provides on SVHC in articles for this part number is based on the latest European Chemicals Agency (ECHA) 'Guidance on requirements for substances in articles' posted at this URL: <https://echa.europa.eu/guidance-documents/guidance-on-reach>

Compatible Parts

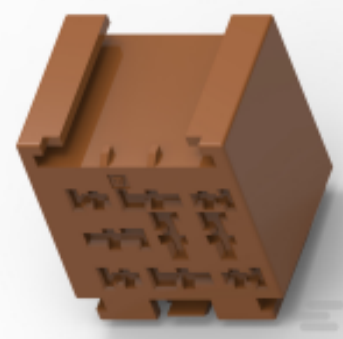
 <p>TE Part # 185847-2 AUTO FUSE HOLDER BLACK</p>	 <p>TE Part # 185402-1 MODULAR RELAY HOLDER</p>	 <p>TE Part # 185403-1 MODULAR RELAY HOLDER</p>	 <p>TE Part # 185403-2 MODULAR RELAY HOLDER</p>
 <p>TE Part # 1801616-1 FUSES HOLDER 10 MINIFUSES</p>	 <p>TE Part # 1801617-1 FUSES AND RELAYS HOLDER 6 MINIFUSES</p>	 <p>TE Part # 1801618-1 RELAY 40A HOLDER</p>	 <p>TE Part # 1801619-1 RELAY 70A HOLDER</p>
 <p>TE Part # 1801620-1 2 MICRORELAYS HOLDER</p>	 <p>TE Part # 1801773-1 FUSES AND RELAYS HOLDER 6 MINIFUSES V2</p>	 <p>TE Part # 185402-2 MODULAR RELAY HOLDER</p>	 <p>TE Part # 185403-4 MODULAR RELAY HOLDER</p>



TE Part # 185847-1
AUTOFUSE HOLDER WHITE



TE Part # 2151989-1
OCEAN_2.0_APPLICATOR-S-110F155F



TE Part # 2151989-2
OCEAN_2.0_APPLICATOR-S-110F155F



TE Part # 2305570-1
Strip Terminal Cutter-Side Feed-No Crimp



TE Part # 7-2151989-1
OCEAN_2.0_APPLICATOR-S-110F155F



TE Part # 7-2151989-2
OCEAN_2.0_APPLICATOR-S-110F155F



TE Part # 7-2151989-7
OCEAN_2.0_SPARE_PART_KIT-110F155F



TE Part # 185402-3
MODULAR RELAY HOLDER

Also in the Series | Standard Power Timer

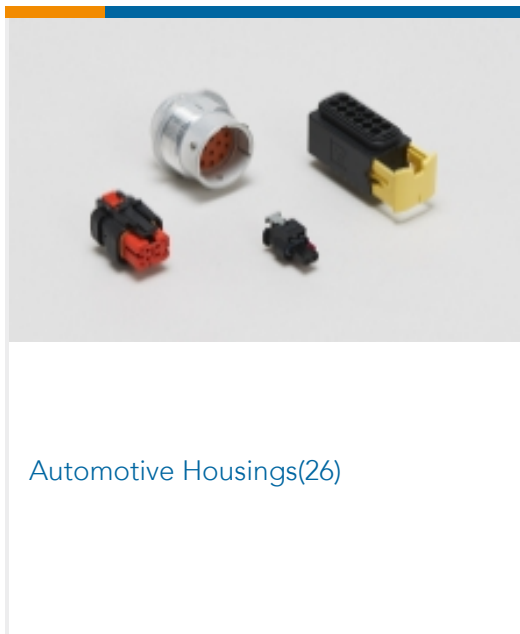

Automotive Housings(26)

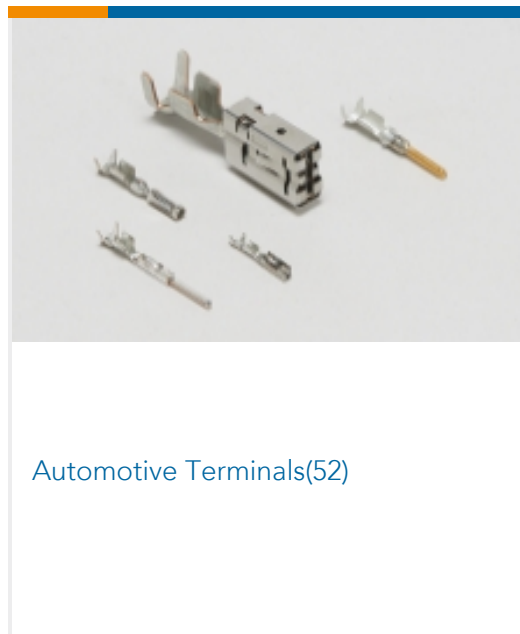

Automotive Terminals(52)

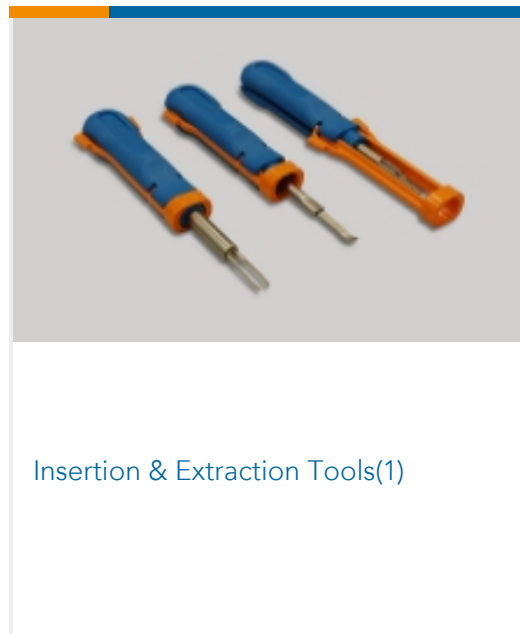

Insertion & Extraction Tools(1)



Module Components(3)

Customers Also Bought



TE Part #1379659-4
8W PLUG HOUSING ASSY GREEN

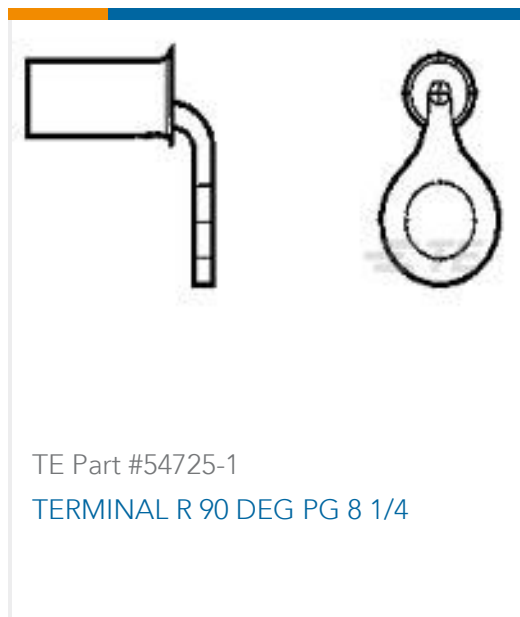

TE Part #54725-1
TERMINAL R 90 DEG PG 8 1/4

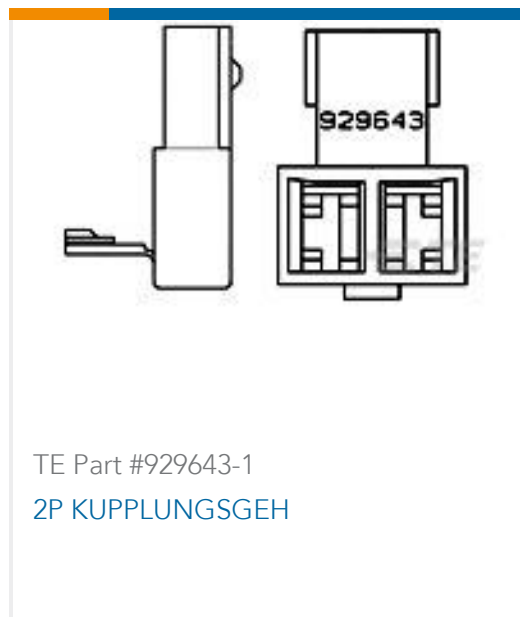

TE Part #929643-1
2P KUPPLUNGSGEH



TE Part #968037-2
SPT A REC 6.3 Contact SWS Sn



TE Part #1801616-1
FUSES HOLDER 10 MINIFUSES

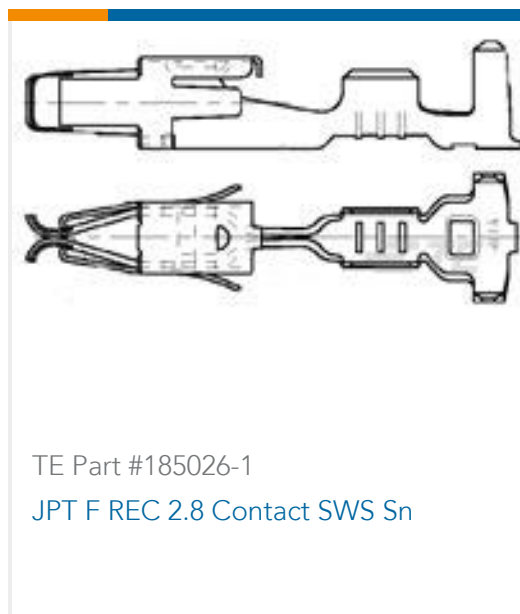

TE Part #185026-1
JPT F REC 2.8 Contact SWS Sn



TE Part #1801432-1
RCPT CONT, 8MM NG1+, MAXIFUSE, 5-6 MM2



TE Part #1801614-3
4 MINIFUSES CLIPSHUNT (2,5-4)



TE Part #1801620-1
2 MICRORELAYS HOLDER

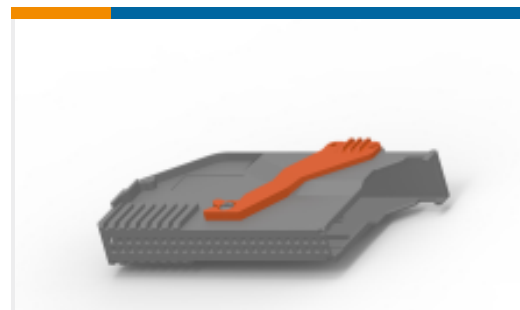

TE Part #7-1393448-7
50P COVER CAP

Documents

Product Drawings

STD PW TIMER W/BARRIER

English

CAD Files

3D PDF

3D

Customer View Model

[ENG_CVM_CVM_144617-1_B.2d_dxf.zip](#)

English

Customer View Model

[ENG_CVM_CVM_144617-1_B.3d_igs.zip](#)

English

Customer View Model

[ENG_CVM_CVM_144617-1_B.3d_stp.zip](#)

English

By downloading the CAD file I accept and agree to the [Terms and Conditions](#) of use.

Datasheets & Catalog Pages

Timer Interconnection System

English

Product Specifications

STANDARD POWER TIMER SUR MACHINE AUTOMATIQUE

English

Application Specification

English