

927367-1 ✓ ACTIVE

AMP | Timer Connector System

TE Internal #: 927367-1

Housing for Female Terminals, Wire-to-Wire / Wire-to-Board, 8 Position, .2 in [5.08 mm] Centerline, Red, Wire & Cable, Power, Timer Connector System

[View on TE.com >](#)



Connectors > Automotive Connectors > Automotive Housings > Timer Connector Housing



Connector System: **Wire-to-Board, Wire-to-Wire**

Number of Positions: **8**

Connector & Housing Type: **Housing for Female Terminals**

Centerline (Pitch): **5.08 mm [.2 in]**

Sealable: **No**

[All Timer Connector Housing \(525\)](#)

Features

Product Type Features

Mixed & Hybrid Connector	No
Connector Shape	Rectangular
Connector System	Wire-to-Board, Wire-to-Wire
Connector & Housing Type	Housing for Female Terminals
Sealable	No
Connector & Contact Terminates To	Wire & Cable
Primary Locking Feature	On the Terminal

Configuration Features

Number of Positions	8
Number of Rows	2

Electrical Characteristics

Nominal Voltage Architecture	12 V, 24 V
------------------------------	------------

Body Features

Primary Product Color	Red
Connector & Keying Code	C

Contact Features

--	--



Contact Size	2.8mm
Contact Type	Receptacle
Mating Tab Width	2.8 mm[.11 in]
Contact Current Rating (Max)	30 A

Mechanical Attachment

Terminal Position Assurance	Yes
Strain Relief	Without
Mating Alignment Type	Keyed
Mating Alignment	With
Connector Mounting Type	Cable Mount (Free-Hanging)

Housing Features

Housing Material	PA
Centerline (Pitch)	5.08 mm[.2 in]

Dimensions

Connector Height	23 mm[.906 in]
Product Width	13.8 mm[.543 in]
Product Length	28.8 mm[1.134 in]
Row-to-Row Spacing	5.08 mm[.2 in]

Usage Conditions

Operating Temperature (Max)	130 °C[266 °F]
Operating Temperature Range	-40 – 130 °C[-40 – 266 °F]

Operation/Application

Circuit Application	Power
---------------------	-------

Packaging Features

Packaging Method	Bag
------------------	-----

Other

Serviceable	No
Connector Position Assurance Capable	No

Product Compliance

For compliance documentation, visit the product page on [TE.com](#)>

EU RoHS Directive 2011/65/EU	Compliant
------------------------------	-----------



EU ELV Directive 2000/53/EC	Compliant
China RoHS 2 Directive MIIT Order No 32, 2016	No Restricted Materials Above Threshold
EU REACH Regulation (EC) No. 1907/2006	Current ECHA Candidate List: JUNE 2023 (235) Candidate List Declared Against: JUNE 2023 (235) Does not contain REACH SVHC
Halogen Content	BFR/CFR/PVC Free, but Br/Cl >900 ppm in other sources.
Solder Process Capability	Not applicable for solder process capability

Product Compliance Disclaimer

This information is provided based on reasonable inquiry of our suppliers and represents our current actual knowledge based on the information they provided. This information is subject to change. The part numbers that TE has identified as EU RoHS compliant have a maximum concentration of 0.1% by weight in homogenous materials for lead, hexavalent chromium, mercury, PBB, PBDE, DBP, BBP, DEHP, DIBP, and 0.01% for cadmium, or qualify for an exemption to these limits as defined in the Annexes of Directive 2011/65/EU (RoHS2). Finished electrical and electronic equipment products will be CE marked as required by Directive 2011/65/EU. Components may not be CE marked. Additionally, the part numbers that TE has identified as EU ELV compliant have a maximum concentration of 0.1% by weight in homogenous materials for lead, hexavalent chromium, and mercury, and 0.01% for cadmium, or qualify for an exemption to these limits as defined in the Annexes of Directive 2000/53/EC (ELV). Regarding the REACH Regulation, the information TE provides on SVHC in articles for this part number is based on the latest European Chemicals Agency (ECHA) 'Guidance on requirements for substances in articles' posted at this URL: <https://echa.europa.eu/guidance-documents/guidance-on-reach>

Compatible Parts



TE Part # CAT-T4827-CH8172
Timer Connector Housing



TE Part # CAT-T4827-T273
TIMER, RECEPTACLE AND TAB

Also in the Series | Timer Connector System



Automotive Connector Caps & Covers (10)



Automotive Connector Locks & Position Assurance(14)



Automotive Housings(210)



Automotive Terminals(137)

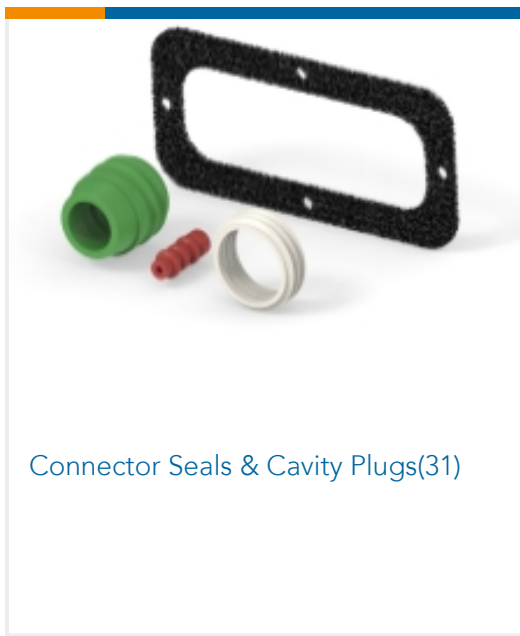

Connector Seals & Cavity Plugs(31)

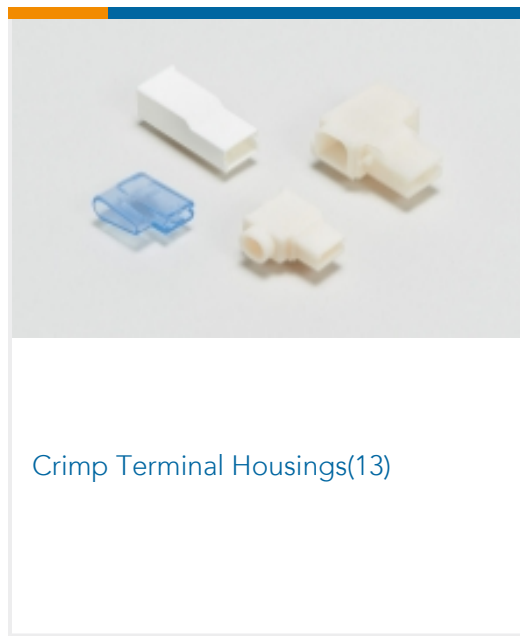

Crimp Terminal Housings(13)

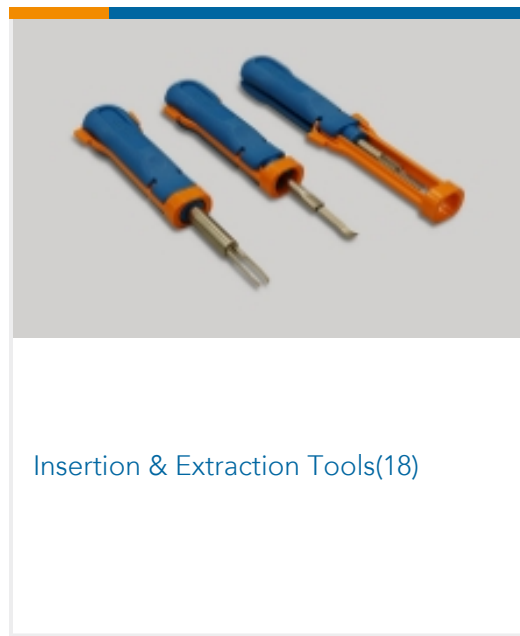

Insertion & Extraction Tools(18)

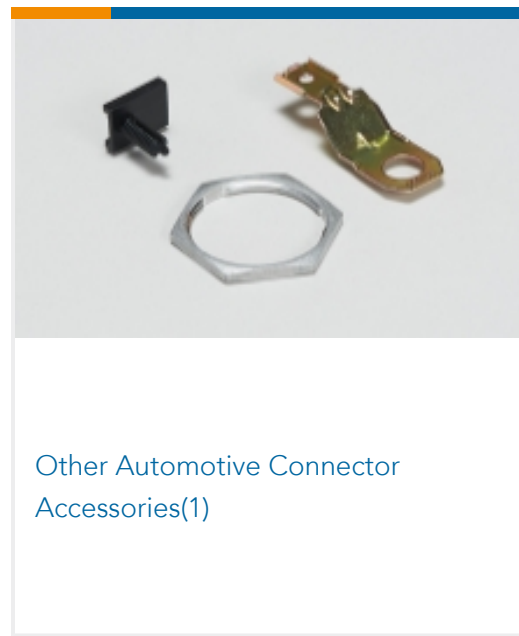

Other Automotive Connector Accessories(1)



PCB Headers & Receptacles(77)

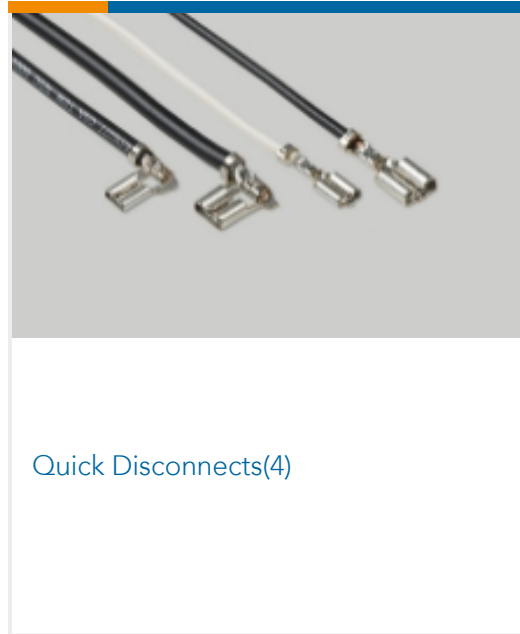

Quick Disconnects(4)

Customers Also Bought



TE Part #969191-2
Timer Connector Housing

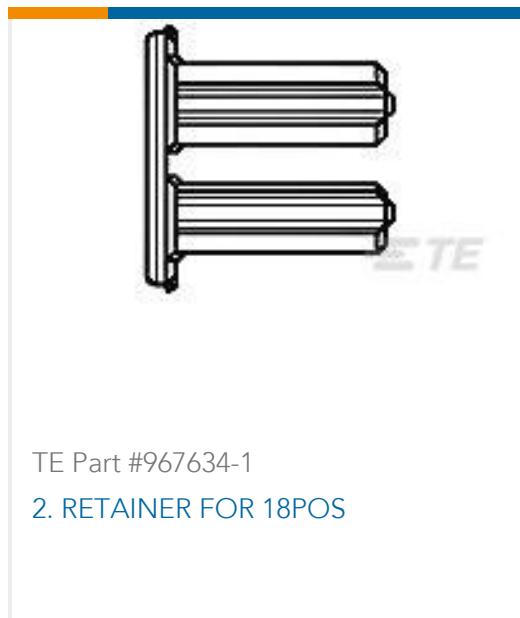

TE Part #967634-1
2. RETAINER FOR 18POS



TE Part #1-967627-1
AMP MCP Unsealed Connector Housings



TE Part #925590-2
TIMER, RECEPTACLE AND TAB



TE Part #1-963745-1
SPECIAL TERMINAL 20-17 AWG PTPB LP

Documents

Product Drawings

8P MIN D-FLACHF GEH

English

8P MIN D-FLACHF GEH

English

CAD Files

3D PDF



English

Customer View Model

[ENG_CVM_927367-1_E1.2d_dxf.zip](#)

English

Customer View Model

[ENG_CVM_927367-1_E1.3d_igs.zip](#)

English

Customer View Model

[ENG_CVM_927367-1_E1.3d_stp.zip](#)

English

By downloading the CAD file I accept and agree to the [Terms and Conditions](#) of use.

Datasheets & Catalog Pages

[Timer Interconnection System](#)

English