

1-967623-4 ✓ ACTIVE

Junior Power Timer

TE Internal #: 1-967623-4

TE Internal Description: JUN-POW-TIM GEH 15P

Timer Connector Housing

[View on TE.com >](#)



All Timer Connector Housing (525)

Product Compliance

[For compliance documentation, visit the product page on TE.com>](#)

EU RoHS Directive 2011/65/EU	Compliant
EU ELV Directive 2000/53/EC	Compliant
China RoHS 2 Directive MIIT Order No 32, 2016	No Restricted Materials Above Threshold
EU REACH Regulation (EC) No. 1907/2006	Current ECHA Candidate List: JUNE 2023 (235) Candidate List Declared Against: JUNE 2023 (235) Does not contain REACH SVHC
Halogen Content	BFR/CFR/PVC Free, but Br/Cl >900 ppm in other sources.
Solder Process Capability	Not applicable for solder process capability

Product Compliance Disclaimer

This information is provided based on reasonable inquiry of our suppliers and represents our current actual knowledge based on the information they provided. This information is subject to change. The part numbers that TE has identified as EU RoHS compliant have a maximum concentration of 0.1% by weight in homogenous materials for lead, hexavalent chromium, mercury, PBB, PBDE, DBP, BBP, DEHP, DIBP, and 0.01% for cadmium, or qualify for an exemption to these limits as defined in the Annexes of Directive 2011/65/EU (RoHS2). Finished electrical and electronic equipment products will be CE marked as required by Directive 2011/65/EU. Components may not be CE marked. Additionally, the part numbers that TE has identified as EU ELV compliant have a maximum concentration of 0.1% by weight in homogenous materials for lead, hexavalent chromium, and mercury, and 0.01% for cadmium, or qualify for an exemption to these limits as defined in the Annexes of Directive 2000/53/EC (ELV). Regarding the REACH Regulation, the information TE provides on SVHC in articles for this part number is based on the latest European Chemicals Agency (ECHA) 'Guidance on requirements for substances in articles' posted at this URL: <https://echa.europa.eu/guidance-documents/guidance-on-reach>

Compatible Parts



TE Part # CAT-M4599-H342
AMP MCP Unsealed Headers



TE Part # 967633-1
2. KONT-SICHERUNG 15P



TE Part # CAT-T4827-CH8172
Timer Connector Housing



TE Part # CAT-LMPH9507
Low & Medium Power Header



TE Part # CAT-T4827-T273
TIMER, RECEPTACLE AND TAB



TE Part # 2445755-1
TPA REC HSG,15POS

TE Part # 1719810-1
JPT REC 2.8 Contact SRC Sn

TE Part # 1-927768-1
JPT REC 2.8 Contact SRC Au

Also in the Series | Junior Power Timer



Automotive Connector Caps & Covers (4)



Automotive Housings(231)



Automotive Terminals(82)



Busbars & Terminals(1)



Connector Seals & Cavity Plugs(9)



Insertion & Extraction Tools(8)



Module Components(3)

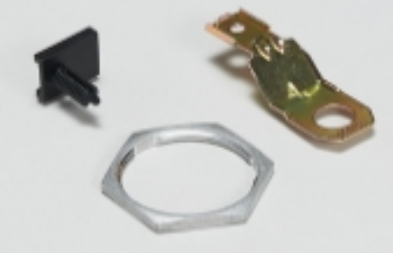

Other Automotive Connector Accessories(1)

Customers Also Bought



TE Part #1-967621-4
Timer Connector Housing

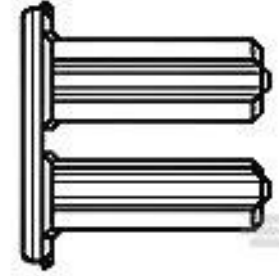

TE Part #967633-1
2. KONT-SICHERUNG 15P



TE Part #826629-9
9P AMPMODU II STIFT LEI



Documents

Product Drawings

[JUN-POW-TIM GEH 15P](#)

English

CAD Files

Customer View Model

[ENG_CVM_1-967623-4_D.3d_igs.zip](#)

English

Customer View Model

[ENG_CVM_1-967623-4_D.3d_stp.zip](#)

English

Customer View Model

[ENG_CVM_1-967623-4_D.2d_dxf.zip](#)

English

3D PDF

English

By downloading the CAD file I accept and agree to the [Terms and Conditions](#) of use.

Datasheets & Catalog Pages

[Timer Interconnection System](#)

English

Product Specifications

[Product Specification](#)

English

[Product Specification](#)

English