

172342-1 ✓ ACTIVE

MATE-N-LOK | Mini-Universal MATE-N-LOK

TE Internal #: 172342-1

Rectangular Power Connectors, Housing, Plug, Wire-to-Wire, 15 Position, 4.2 mm [.165 in] Centerline, Wire & Cable, UL 94V-2, Mini-Universal MATE-N-LOK

[View on TE.com >](#)



Connectors > Power Connectors > Rectangular Power > Rectangular Power Connectors

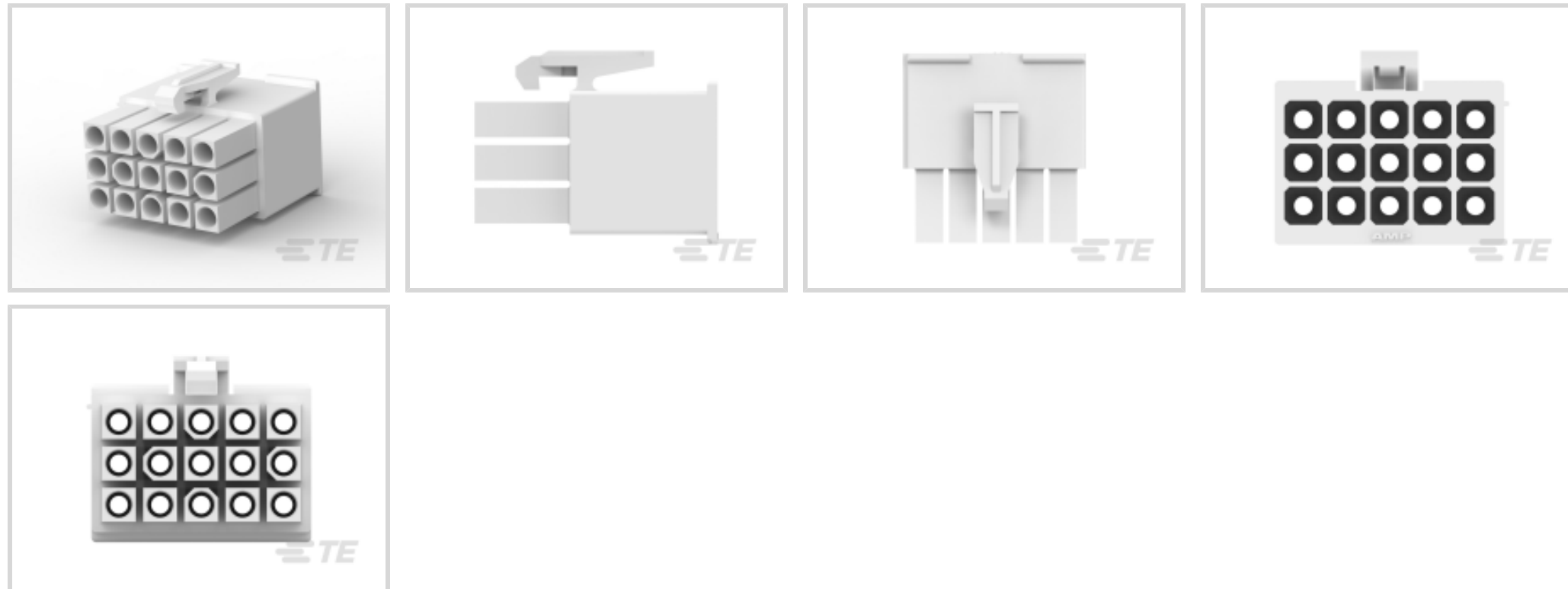

Rectangular Power Connector Type: **Housing**

Connector & Housing Type: **Plug**

Connector System: **Wire-to-Wire**

Number of Positions: **15**

Centerline (Pitch): **4.2 mm [.165 in]**

Features

Product Type Features

Rectangular Power Connector Type	Housing
Connector & Housing Type	Plug
Connector System	Wire-to-Wire
Sealable	No
Connector & Contact Terminates To	Wire & Cable

Configuration Features

Number of Positions	15
Number of Rows	3

Electrical Characteristics

Operating Voltage	600 VDC
-------------------	---------

Contact Features

Multiple Contact Types	Without
Contact Layout	Matrix
Contact Retention Within Housing	Without



Contact Type	Socket
--------------	--------

Termination Features

Termination Method to Wire & Cable	Crimp
------------------------------------	-------

Mechanical Attachment

Panel Mount Feature	Without
---------------------	---------

Connector Mounting Type	Cable Mount (Free-Hanging)
-------------------------	----------------------------

Housing Features

Centerline (Pitch)	4.2 mm [.165 in]
--------------------	------------------

Housing Color	Natural
---------------	---------

Housing Material	Nylon 6/6
------------------	-----------

Dimensions

Connector Height	16 mm
------------------	-------

Product Width	22.4 mm
---------------	---------

Product Length	23.7 mm
----------------	---------

Row-to-Row Spacing	4.14 mm [.163 in]
--------------------	-------------------

Usage Conditions

Operating Temperature Range	-20 – 105 °C [-4 – 221 °F]
-----------------------------	----------------------------

Operation/Application

Circuit Application	Power & Signal
---------------------	----------------

Industry Standards

CSA Rating	Certified, LR 7189
------------	--------------------

UL Rating	Recognized
-----------	------------

Compatible With Agency/Standards Products	CSA, UL
---	---------

Compatible With Approved Standards Products	UL E28476
---	-----------

UL Flammability Rating	UL 94V-2
------------------------	----------

Glow Wire Rating	Standard Part - Not Glow Wire
------------------	-------------------------------

Packaging Features

Packaging Quantity	500
--------------------	-----

Packaging Method	Bag
------------------	-----

Product Compliance

[For compliance documentation, visit the product page on TE.com>](#)



EU RoHS Directive 2011/65/EU	Compliant
EU ELV Directive 2000/53/EC	Compliant
China RoHS 2 Directive MIIT Order No 32, 2016	No Restricted Materials Above Threshold
EU REACH Regulation (EC) No. 1907/2006	Current ECHA Candidate List: JUNE 2023 (235) Candidate List Declared Against: JUNE 2023 (235) Does not contain REACH SVHC
Halogen Content	Low Halogen - Br, Cl, F, I < 900 ppm per homogenous material. Also BFR/CFR/PVC Free
Solder Process Capability	Not applicable for solder process capability







Product Compliance Disclaimer

This information is provided based on reasonable inquiry of our suppliers and represents our current actual knowledge based on the information they provided. This information is subject to change. The part numbers that TE has identified as EU RoHS compliant have a maximum concentration of 0.1% by weight in homogenous materials for lead, hexavalent chromium, mercury, PBB, PBDE, DBP, BBP, DEHP, DIBP, and 0.01% for cadmium, or qualify for an exemption to these limits as defined in the Annexes of Directive 2011/65/EU (RoHS2). Finished electrical and electronic equipment products will be CE marked as required by Directive 2011/65/EU. Components may not be CE marked. Additionally, the part numbers that TE has identified as EU ELV compliant have a maximum concentration of 0.1% by weight in homogenous materials for lead, hexavalent chromium, and mercury, and 0.01% for cadmium, or qualify for an exemption to these limits as defined in the Annexes of Directive 2000/53/EC (ELV). Regarding the REACH Regulation, the information TE provides on SVHC in articles for this part number is based on the latest European Chemicals Agency (ECHA) 'Guidance on requirements for substances in articles' posted at this URL: <https://echa.europa.eu/guidance-documents/guidance-on-reach>

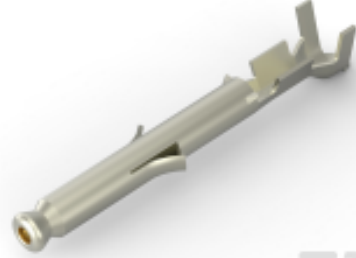
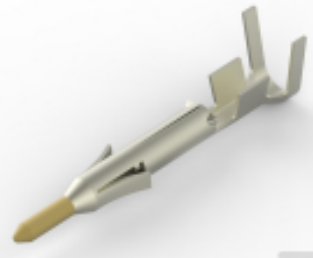



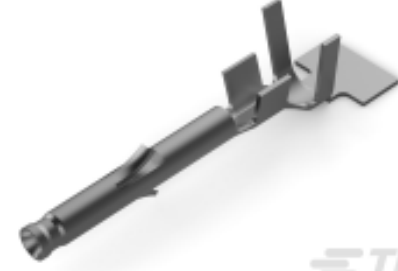
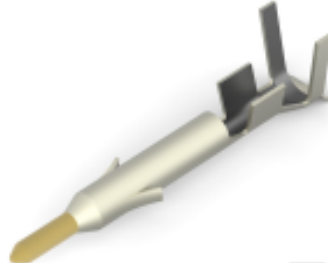
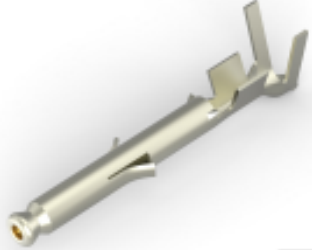



Compatible Parts

 <p>TE Part # 1-770988-1 MINI UMNL SOK 22-18AWG LP LF</p>	 <p>TE Part # 1-770985-0 MINI UMNL PIN 26-22AWG AU LP</p>	 <p>TE Part # 1-770987-0 MINI UMNL PIN 22-18 AWG AU LP</p>	 <p>TE Part # 770988-3 MINI UMNL SOK 22-18AWG AU LP</p>
 <p>TE Part # 1-770988-0 MINI UMNL SOK 22-18AWG AU</p>	 <p>TE Part # 1-794059-0 MINI UMNL PIN L/P LF</p>	 <p>TE Part # 770988-1 MINI UMNL SOK 22-18AWG SN LP</p>	 <p>TE Part # 770986-1 MINI UMNL SOK 26-22AWG SN LP</p>

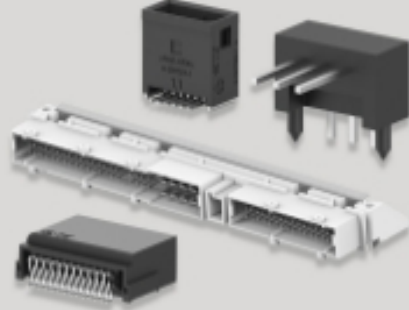

 <p>TE Part # 794058-1 MINI UMNL SOK L/P</p>	 <p>TE Part # 170365-3 MINI UNIVERSAL M-N-L SOCKET LP</p>	 <p>TE Part # 170364-3 MINI UNIVERSAL M-N-L PIN LP</p>	 <p>TE Part # 770985-1 MINI UMNL PIN 26-22AWG SN LP</p>
 <p>TE Part # 1-794407-1 MINI UMNL SOK 20-16 AWG AU LF</p>	 <p>TE Part # 170363-3 MINI UNIVERSAL M-N-L PIN LP</p>	 <p>TE Part # 171638-1 MINI U-M-N-L PIN CONT. L.P</p>	 <p>TE Part # 171639-1 MINI U-M-N-L SOCKET LP</p>
 <p>TE Part # 770903-3 MINI UMNL PIN 22-18 AWG AU</p>	 <p>TE Part # 170366-3 MINI UNIVERSAL M-N-L SOCKET LP</p>	 <p>TE Part # 794059-1 MINI UMNL PIN L/P</p>	 <p>TE Part # 172334-1 MINI UMNL CAP HOUSING 15P</p>

Also in the Series | Mini-Universal MATE-N-LOK

 <p>Connector Caps & Covers(2)</p>	 <p>Connector Contacts(92)</p>	 <p>Connector Hardware(4)</p>	 <p>Connector Seals & Cavity Plugs(17)</p>
 <p>Connector Strain Relief(2)</p>	 <p>Insertion & Extraction Tools(1)</p>	 <p>PCB Headers & Receptacles(1)</p>	 <p>Rectangular Power Connectors(197)</p>

Customers Also Bought

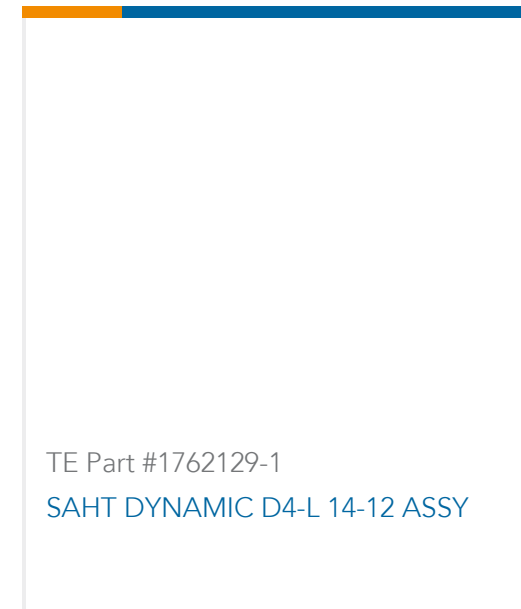
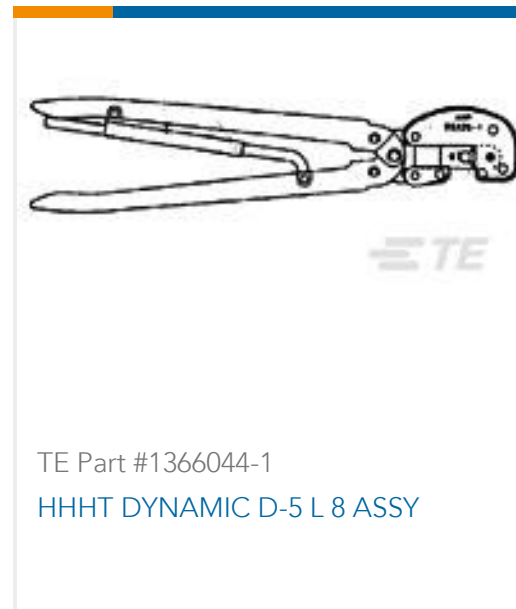

Documents

Product Drawings

MINI UMNL PLUG HOUSING 15P

English

CAD Files

3D PDF

3D

Customer View Model

[ENG_CVM_CVM_172342-1_F.2d_dxf.zip](#)

English

Customer View Model

[ENG_CVM_CVM_172342-1_F.3d_igs.zip](#)

English

Customer View Model

[ENG_CVM_CVM_172342-1_F.3d_stp.zip](#)

English

Customer View Model

[ENG_CVM_172342-1_A1.2d_dxf.zip](#)

English

Customer View Model

[ENG_CVM_172342-1_A1.3d_igs.zip](#)

English

Customer View Model

[ENG_CVM_172342-1_A1.3d_stp.zip](#)

English

3D PDF

English



By downloading the CAD file I accept and agree to the [Terms and Conditions](#) of use.

Datasheets & Catalog Pages

[SOFT_SHELL_PIN_AND_SOCKET_CONNECTORS_CATALOG](#)

English

Product Specifications

[Application Specification](#)

English

Instruction Sheets

[Instruction Sheet \(U.S.\)](#)

English

[Instruction Sheet \(U.S.\)](#)

English

Agency Approvals

[Agency Approval Document](#)

English