



P-DUKE POWER

HAE75W Series

Half-Brick DC-DC Converter
Up to 75 Watts

3
YEARS
WARRANTY

ROHS
COMPLIANT

REACH
COMPLIANT



Railway



Automation



Datacom



IPC



Industry



Measurement



Telecom



Automobile



Boat



Charger



Medical



PV



3000 VAC
Reinforced
Insulation

3000 VDC
Isolation
Voltage

4 : 1
Wide
Input
Range

NO
Min. Load
Required

REMOTE
ON
OFF

OCP

OTP

OVP

SCP

UVP

PART NUMBER STRUCTURE

DIP Type:

HAE75	- 48	S	05	W -	P	HS
Series Name	Input Voltage (VDC)	Output Quantity	Output Voltage (VDC)	Input Range	Ctrl and Pin Options	Assembly Options
	24:9~36 48:18~75 110:43~160	S:Single	3P3:3.3 05:5 12:12 15:15 24:24 28:28 48:48	4:1	□:Negative logic; 0.20" pin length L:Negative logic; 0.145" pin length P:Positive logic; 0.20" pin length S:Positive logic; 0.145" pin length	□: None Heat-sink type HS: 7G-0021A-F; H=0.45" HS3: 7G-0024A-F; H=0.45" HS4: 7GA0127P01-F; H=0.65" HS5: 7GA0128P01-F; H=1" Through hole type TH: No thread* *The module can't equip Heat-sink with TH option.

Wall Mounted Type:

HAE75	- 48	S	05	W -	P	TF1	R
Series Name	Input Voltage (VDC)	Output Quantity	Output Voltage (VDC)	Input Range	Ctrl and Pin Options	Assembly Options	Conformal Coating Options
	24:9~36 48:18~75 110:43~160	S:Single	3P3:3.3 05:5 12:12 15:15 24:24 28:28 48:48	4:1	□:Negative logic; 0.20" pin length P:Positive logic; 0.20" pin length	T: Without EMC filter TF1: Integrated EMC filter and meets EN55032 Class A can be connected to PE	□: None R: Conformal Coating

1. The terminal block type is only for assembly of 0.20 "pin length.

TECHNICAL SPECIFICATION All specifications are typical at nominal input, full load and 25°C unless otherwise noted

Model Number	Input Range	Output Voltage	Output Current @Full Load	Input Current @No Load	Efficiency	Maximum Capacitor Load
	VDC	VDC	A	mA	%	μF
HAE75-24S3P3W	9 ~ 36	3.3	20	85	87	60600
HAE75-24S05W	9 ~ 36	5	15	120	88	30000
HAE75-24S12W	9 ~ 36	12	6.3	185	88	5250
HAE75-24S15W	9 ~ 36	15	5	185	88	3330
HAE75-24S24W	9 ~ 36	24	3.2	85	87	1330
HAE75-24S28W	9 ~ 36	28	2.7	85	87	960
HAE75-24S48W	9 ~ 36	48	1.6	85	87	330
HAE75-48S3P3W	18 ~ 75	3.3	20	60	88	60600
HAE75-48S05W	18 ~ 75	5	15	60	90	30000
HAE75-48S12W	18 ~ 75	12	6.3	90	90	5250
HAE75-48S15W	18 ~ 75	15	5	50	89	3330
HAE75-48S24W	18 ~ 75	24	3.2	50	88	1330
HAE75-48S28W	18 ~ 75	28	2.7	50	88	960
HAE75-48S48W	18 ~ 75	48	1.6	50	87	330
HAE75-110S3P3W	43 ~ 160	3.3	20	10	89	60600
HAE75-110S05W	43 ~ 160	5	15	10	91	30000
HAE75-110S12W	43 ~ 160	12	6.3	10	91	5250
HAE75-110S15W	43 ~ 160	15	5	10	91	3330
HAE75-110S24W	43 ~ 160	24	3.2	10	90	1330
HAE75-110S28W	43 ~ 160	28	2.7	10	90	960
HAE75-110S48W	43 ~ 160	48	1.6	10	90	330

INPUT SPECIFICATIONS						
Parameter	Conditions		Min.	Typ.	Max.	Unit
Operating input voltage range	24Vin(nom)		9	24	36	VDC
	48Vin(nom)		18	48	75	
	110Vin(nom)		43	110	160	
Start up voltage	24Vin(nom)				9	VDC
	48Vin(nom)				18	
	110Vin(nom)				43	
Shutdown voltage	24Vin(nom)		7.3	7.7	8.1	VDC
	48Vin(nom)		15.5	16	16.3	
	110Vin(nom)		33.0	34.5	36.0	
Start up time	Constant resistive load	Power up	110Vin(nom)		60	ms
		Others			25	
		Remote ON/OFF	110Vin(nom)		60	
Input surge voltage	1 second, max.	24Vin(nom)			50	VDC
		48Vin(nom)			100	
		110Vin(nom)			185	
Input filter (1)			Pi type			
Remote ON/OFF	Referred to -Vin pin	Negative logic (Standard)	DC-DC ON	Short or 0 ~ 1.2VDC		
		Positive logic (Option)	DC-DC OFF	Open or 3 ~ 12 VDC		
			DC-DC ON	Open or 3 ~ 12 VDC		
		DC-DC OFF	Short or 0 ~ 1.2VDC			
		Input current of Ctrl pin	-0.5		1	mA
		Remote off input current		3		mA

OUTPUT SPECIFICATIONS					
Parameter	Conditions	Min.	Typ.	Max.	Unit
Voltage accuracy		-1.0		+1.0	%
Line regulation	Low Line to High Line at Full Load	-0.1		+0.1	%
Load regulation	No Load to Full Load	-0.1		+0.1	%
Voltage adjustability	Maximum output deviation is inclusive of remote sense	-20		+10	%
Remote sense	% of Vout(nom) If remote sense is not being used, Sense pins should be connected to corresponding polarity OUTPUT pins.			10	%
Ripple and noise	Measured by 20MHz bandwidth With a 4.7µF/50V X7R MLCC With a 4.7µF/50V X7R MLCC With a 4.7µF/50V X7R MLCC With a 2.2µF/100V X7R MLCC		3.3Vout, 5Vout 12Vout, 15Vout 24Vout, 28Vout 48Vout	75 100 200 300	100 125 250 350 mVp-p
Temperature coefficient		-0.02		+0.02	%/°C
Transient response recovery time	25% load step change		200	250	µs
Over voltage protection	% of Vout(nom); Hiccup mode	115		130	%
Over load protection	% of Iout rated; Hiccup mode		150		%
				140	%
Short circuit protection					Continuous, automatic recovery

GENERAL SPECIFICATIONS					
Parameter	Conditions	Min.	Typ.	Max.	Unit
Isolation voltage	1 minute(Reinforced insulation) 110Vin(nom) Input to Output Input (Output) to Case	3000			VAC
	1 minute Others Input to Output Input (Output) to Case	3000			VDC
Isolation resistance	500VDC	1			GΩ
Isolation capacitance				2500	pF
Switching frequency		270	300	330	kHz
Safety approvals	IEC/ EN/ UL62368-1				UL:E193009 CB:UL(Demko)
Standard approvals	EN50155 EN45545-2				
Case material	24Vin(nom) and 48Vin(nom) 110Vin(nom)				Metal Aluminum base-plate with plastic case
Base material	24Vin(nom) and 48Vin(nom)				FR4 PCB
Potting material					Silicone (UL94 V-0)
Weight	Module stand alone HAE75-□□S□□W -T HAE75-□□S□□W -TF1				97g (3.42oz) 200g (7.05oz) 287g (10.12oz)
MTBF	MIL-HDBK-217F, Full load				3.362×10 ⁵ hrs

ENVIRONMENTAL SPECIFICATIONS					
Parameter	Conditions	Min.	Typ.	Max.	Unit
Operating case temperature	Base-plate	-40		+105	°C
Maximum case temperature				105	°C
Over temperature protection			115		°C
Storage temperature range	Terminal block type	-40		+105	°C
	Others	-55		+125	°C
Thermal impedance	Module without assembly options		6.7		°C/W
	Heat-sink type with 0.45" Height		4.7		
	Heat-sink type with 0.65" Height		3.7		
	Heat-sink type with 1" Height		3.0		
Thermal shock					MIL-STD-810F
Shock					EN61373, MIL-STD-810F
Vibration					EN61373, MIL-STD-810F
Relative humidity					5% to 95% RH

EMC SPECIFICATIONS		
Parameter	Conditions	Level
EMI	EN55032, EN50121-3-2 HAE75-□□S□□W-TF1 Other models; with external components *Connecting four screw bolts to shield plane will help to reduce the EMI.	Class A Class A, Class B
EMS	EN55035, EN50121-3-2	
ESD	EN61000-4-2 Air ± 8kV and Contact ± 6kV	Perf. Criteria A
Radiated immunity	EN61000-4-3 20V/m	Perf. Criteria A
Fast transient	EN61000-4-4 ± 2kV HAE75-24S□□W HAE75-48S□□W With 2 pcs of aluminum electrolytic capacitor (Nippon Chemi-con KY series, 220μF/100V) HAE75-110S□□W With 2 pcs of aluminum electrolytic capacitor (Nippon Chemi-con KXJ series, 150μF/200V)	Perf. Criteria A
Surge	EN61000-4-5 ±2kV HAE75-24S□□W HAE75-48S□□W With 2 pcs of aluminum electrolytic capacitor (Nippon Chemi-con KY series, 220μF/100V) HAE75-110S□□W With 2 pcs of aluminum electrolytic capacitor (Nippon Chemi-con KXJ series, 150μF/200V)	Perf. Criteria A
Conducted immunity	EN61000-4-6 10Vr.m.s	Perf. Criteria A
Power frequency magnetic field	EN61000-4-8 100A/m continuous; 1000A/m 1 second	Perf. Criteria A

Note:

- Input source impedance: The power module will operate as specifications without external components, assuming that the source voltage has a very low impedance and reasonable input voltage regulation. Highly inductive source impedances can affect the stability of the power module. Since real-world voltage source has finite impedance, performance can be improved by adding external filter capacitor. The HAE75-24S□□W recommended 4.7μF/50V X7R MLCC or Nippon Chemi-con KY series, 68μF /100V or better capacitor.

CAUTION: This power module is not internally fused. An input line fuse must always be used.

CHARACTERISTIC CURVE

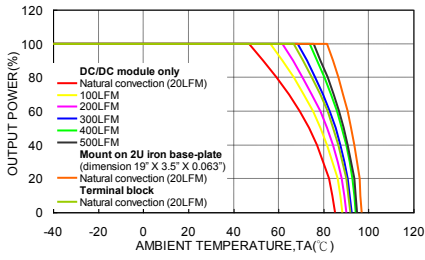

HAE75-48S05W Derating Curve
(See Thermal Considerations)

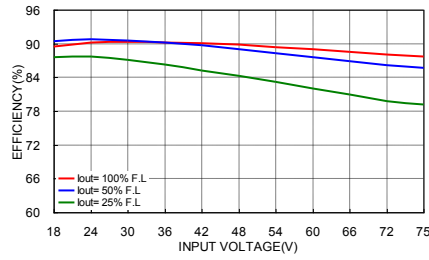

HAE75-48S05W Efficiency vs. Input Voltage

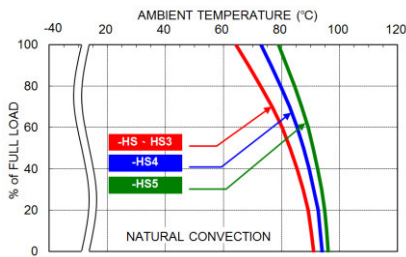

HAE75-48S05W Derating Curve with Heat-sink
(See Thermal Considerations)

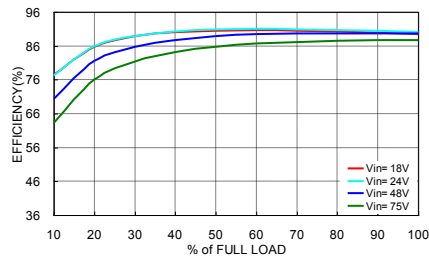

HAE75-48S05W Efficiency vs. Output Load

TERMINAL BLOCK TYPE OPTION

HAE75-□□S□□W -T

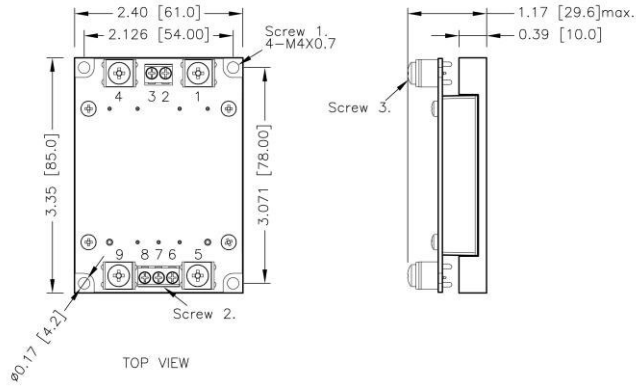

TERMINAL CONNECTION : -T

NO.	DEFINE
1	-Vin
2	Case / NC*
3	Ctrl
4	+Vin
5	-Vout
6	-Sense
7	Trim
8	+Sense
9	+Vout

- All dimensions in inch [mm]
- Tolerance :x.xx±0.02 [x.x±0.5]
x.xxx±0.01 [x.xx±0.25]
- Screw 1 locked torque:
MAX 11.2kgf-cm/ 1.10N-m
- Screw 2 locked torque:
MAX 5.2kgf-cm/ 0.51N-m
- Screw 3 locked torque:
MAX 12.0kgf-cm/ 1.18N-m

HAE75-□□S□□W -TF1

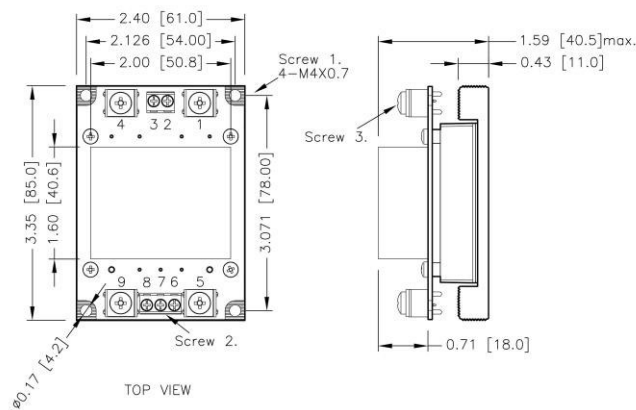

TERMINAL CONNECTION : -TF1

NO.	DEFINE
1	-Vin
2	NC
3	Ctrl
4	+Vin
5	-Vout
6	-Sense
7	Trim
8	+Sense
9	+Vout

RECOMMENDED PAD LAYOUT

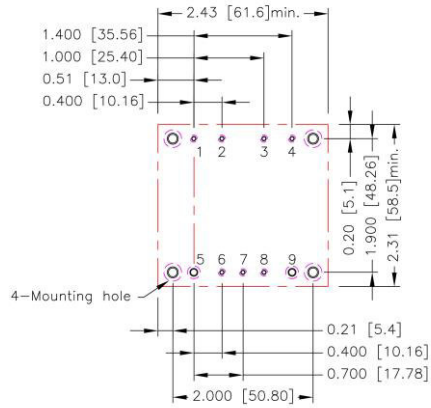

All dimensions in inch[mm]
 Pad size(lead free recommended)
 Through hole 1,2,3,4,6,7,8: $\Phi 0.051[1.30]$
 Through hole 5,9: $\Phi 0.091[2.30]$
 Through hole of mounting: $\Phi 0.126[3.20]$
 Top view pad 1,2,3,4,6,7,8: $\Phi 0.064[1.63]$
 Top view pad 5,9: $\Phi 0.113[2.88]$
 Top view pad of mounting: $\Phi 0.157[4.00]$
 Bottom view pad 1,2,3,4,6,7,8: $\Phi 0.102[2.60]$
 Bottom view pad 5,9: $\Phi 0.181[4.60]$
 Bottom view pad of mounting: $\Phi 0.252[6.40]$

THERMAL CONSIDERATIONS

The power module operates in a variety of thermal environments.

However, sufficient cooling should be provided to help ensure reliable operation of the unit.

Heat is removed by conduction, convection, and radiation to the surrounding environment.

Proper cooling can be verified by measuring the point as the figure below.

The temperature at this location should not exceed "Maximum case temperature".

When operating, adequate cooling must be provided to maintain the test point temperature at or below "Maximum case temperature".

You can limit this temperature to a lower value for extremely high reliability.

- Thermal test condition with vertical direction by natural convection (20LFM).
- The Heat-sink is optional and P/N: 7G-0021A-F, 7G-0024A-F, 7GA0127P01-F, 7GA0128P01-F.

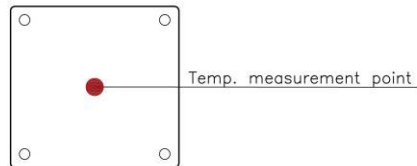

BASE PLATE

HEAT-SINK TYPE OPTIONS

HAE75-□□S□□W -**HS**
7G-0021A-F

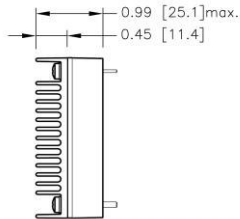
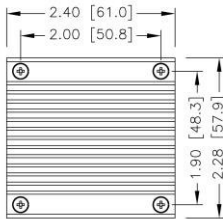

SIDE VIEW

HAE75-□□S□□W -**HS3**
7G-0024A-F

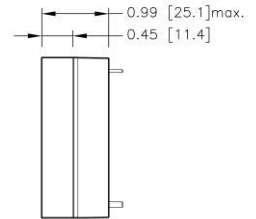
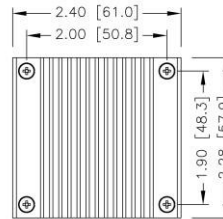

SIDE VIEW

HAE75-□□S□□W -**HS4**
7GA0127P01-F

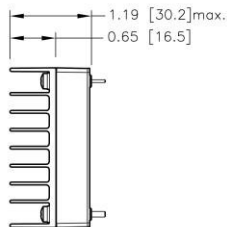
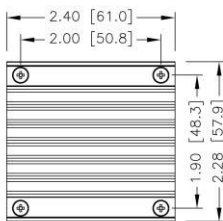

SIDE VIEW

HAE75-□□S□□W -**HS5**
7GA0128P01-F

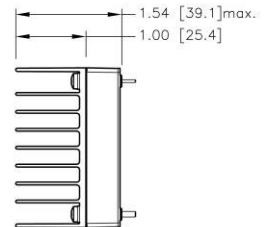
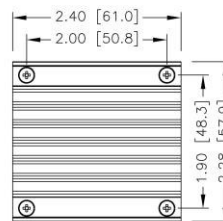

SIDE VIEW

1. All dimensions in inch [mm]
2. Tolerance :x.xx±0.02 [x.x±0.5]
x.xxx±0.01 [x.xx±0.25]

OUTPUT VOLTAGE ADJUSTMENT

Output voltage is adjustable for 10% trim up or -20% trim down of nominal output voltage by connecting an external resistor between the Trim pin and either the +Sense or -Sense pins.

With an external resistor between the Trim and -Sense pin, the output voltage set point decreases.

With an external resistor between the Trim and +Sense pin, the output voltage set point increases.

Maximum output deviation is +10% inclusive of remote sense.

The external TRIM resistor needs to be at least 1/8W of rated power.

Trim Up Equation

$$R_U = \left(\frac{V_{OUT}(100 + \Delta\%) - 100 + 2\Delta\%}{1.225\Delta\%} \right) k\Omega$$

Trim Down Equation

$$R_D = \left(\frac{100}{\Delta\%} - 2 \right) k\Omega$$

EXTERNAL OUTPUT TRIMMING

Output can be externally trimmed by using the method shown below.

Trim-up

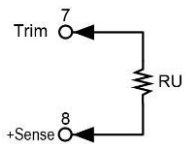

□□S3P3W

ΔV (%)	1	2	3	4	5	6	7	8	9	10
Vout (V)	3.333	3.366	3.399	3.432	3.465	3.498	3.531	3.564	3.597	3.630
RU (kΩ)	170.082	85.388	57.156	43.041	34.571	28.925	24.892	21.867	19.515	17.633

□□S05W

ΔV (%)	1	2	3	4	5	6	7	8	9	10
Vout (V)	5.05	5.10	5.15	5.20	5.25	5.30	5.35	5.40	5.45	5.50
RU (kΩ)	310.245	156.163	104.803	79.122	63.714	53.442	46.105	40.602	36.322	32.898

□□S12W

ΔV (%)	1	2	3	4	5	6	7	8	9	10
Vout (V)	12.12	12.24	12.36	12.48	12.60	12.72	12.84	12.96	13.08	13.20
RU (kΩ)	887.388	447.592	300.993	227.694	183.714	154.395	133.452	117.745	105.528	95.755

□□S15W

ΔV (%)	1	2	3	4	5	6	7	8	9	10
Vout (V)	15.15	15.30	15.45	15.60	15.75	15.90	16.05	16.20	16.35	16.50
RU (kΩ)	1134.735	572.490	385.075	291.367	235.143	197.660	170.886	150.806	135.188	122.694

□□S24W

ΔV (%)	1	2	3	4	5	6	7	8	9	10
Vout (V)	24.24	24.48	24.72	24.96	25.20	25.44	25.68	25.92	26.16	26.40
RU (kΩ)	1876.776	947.184	637.320	482.388	389.429	327.456	283.190	249.990	224.168	203.510

□□S28W

ΔV (%)	1	2	3	4	5	6	7	8	9	10
Vout (V)	28.28	28.56	28.84	29.12	29.40	29.68	29.96	30.24	30.52	30.80
RU (kΩ)	2206.571	1113.714	749.429	567.286	458.000	385.143	333.102	294.071	263.714	239.429

□□S48W

ΔV (%)	1	2	3	4	5	6	7	8	9	10
Vout (V)	48.48	48.96	49.44	49.92	50.40	50.88	51.36	51.84	52.32	52.80
RU (kΩ)	3855.551	1946.367	1309.973	991.776	800.857	673.578	582.665	514.480	461.447	419.020

OUTPUT VOLTAGE ADJUSTMENT(CONTINUED)

Trim-down

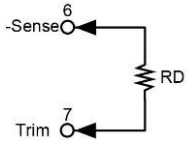

□□S□□W

ΔV (%)	1	2	3	4	5	6	7	8	9	10
RD (k Ω)	98.000	48.000	31.333	23.000	18.000	14.667	12.286	10.500	9.111	8.000
ΔV (%)	11	12	13	14	15	16	17	18	19	20
RD (k Ω)	7.091	6.333	5.692	5.143	4.667	4.250	3.882	3.556	3.263	3.000