



# TAOGLAS®



# Datasheet

## FXP14R Hexa-Band Cellular Antenna

**Part No:**  
FXP14R.A.07.0100A

### Description

AntD© Shunt 10k Ohm Chip Resistor Inside  
850/900/1700/1800/1900/2100MHz  
100mm, Ø1.13 cable, I-PEX MHF® I (U.FL comp)  
Dims: 70\*20\*0.1mm

### Features:

IPEX MHF Connector (U.FL compatible)  
100 mm 1.37 Cable  
70\*20\*.01 mm  
Flexible  
Peel and Stick Mounting  
AntD© Shunt 10k Ohm Chip Resistor Inside  
Cable and Connector Customizable  
RoHS compliant

<b>1.</b>	<b>Introduction</b>	<b>2</b>
<b>2.</b>	<b>Specification</b>	<b>3</b>
<b>3.</b>	<b>Antenna Characteristics</b>	<b>5</b>
<b>4.</b>	<b>Radiation Patterns</b>	<b>9</b>
<b>5.</b>	<b>Mechanical Drawing</b>	<b>18</b>
<b>6.</b>	<b>Packaging</b>	<b>19</b>
<hr/>		
	Changelog	20

Taoglas makes no warranties based on the accuracy or completeness of the contents of this document and reserves the right to make changes to specifications and product descriptions at any time without notice. Taoglas reserves all rights to this document and the information contained herein. Reproduction, use or disclosure to third parties without express permission is strictly prohibited.



# 1. Introduction



The Taoglas FXP14R Hexa Band Cellular Antenna with Integrated AntD© Resistor covers all world-wide 2G/3G bands (850 / 900 / 1700 / 1800 / 1900 / 2100 MHz). Common applications are in GSM / CDMA / DCS / PCS / WCDMA / UMTS/ HSPA / GPRS / EDGE.

The antenna has been designed using a super thin flexible polymer substrate with a rectangular form-factor and cable connection for ease of installation. The antenna radiates well on different plastic materials and thickness. We have selected ABS plastic mounting with 2 mm of thickness as a baseline for testing. Best in class efficiency on lower and upper bands (above 40%) make it an ideal antenna for devices where space for onboard SMT cellular antennas is not available. The antenna is mounted via automotive quality 3M 467MP adhesive and has excellent reliability. The FXP14 has its own ground-plane, therefore it does not need to connect to the ground-plane of the main-board of the device for improved radiation efficiency.

Taoglas unique AntD© technology allows connected radio products to perform diagnostics on the antenna. This includes detection that the proper antenna is connected and that the connection isn't shorted or broken. Contact Taoglas engineering for examples on how to implement AntD© antenna diagnostics in your product. Cable length and connector types are also customizable. Like all such antennas, care should be taken to mount the antenna at least 10mm from metal components or surfaces, and ideally 20mm for best radiation efficiency.

## 2. Specification

LTE Electrical								
Band	Frequency (MHz)	Efficiency (%)	Average Gain (dB)	Peak Gain (dBi)	Impedance	Polarization	Radiation Pattern	Max. input power
<b>5GNR/4G</b> Band71	617-698	19.8	-7.02	-2.47	50 Ω	Linear	Omni	2W
<b>4G/3G</b> Band 12,13,14,17,28,29	698-806	18.2	-7.39	-2.56				
<b>4G/3G/NB-IoT/Cat M</b> Band 5,8,18,19,20,26,27	824-960	38.6	-4.13	3.27				
<b>5GNR/4G</b> Band 21,32,74,75,76	1427-1518	47.0	-3.28	2.86				
<b>4G/3G</b> Band 1,2,3,4,9,23,25,35,39,66	1710-2200	64.0	-1.94	4.18				
<b>4G/3G</b> Band 7,30,38,40,41	2300-2690	34.4	-4.63	3.32				
<b>5GNR/4G</b> Band 22,42,48,77,78,79	3300-5000	60.5	-2.18	4.88				

Mechanical	
Dimensions	70*20*01mm
Connector	MHFII (U.FL Compatible)
Cable Standard	Mini-Coax 1.13mm
Cable Length and color	100 mm,Black

Environmental	
Temperature Range	-40°C to 85°C
Storage Temperature	-40°C to 85°C

5G/4G Bands			
Band Number	5G NR / FR1 / LTE / LTE-Advanced / WCDMA / HSPA / HSPA+ / TD-SCDMA		
	Uplink	Downlink	Covered
B1	1920 to 1980	2110 to 2170	✓
B2	1850 to 1910	1930 to 1990	✓
B3	1710 to 1785	1805 to 1880	✓
B4	1710 to 1755	2110 to 2155	✓
B5	824 to 849	869 to 894	✓
B7	2500 to 2570	2620 to 2690	✓
B8	880 to 915	925 to 960	✓
B9*	1749.9 to 1784.9	1844.9 to 1879.9	✓
B11	1427.9 to 1447.9	1475.9 to 1495.9	✓
B12	699 to 716	729 to 746	✓
B13	777 to 787	746 to 756	✓
B14	788 to 798	758 to 768	✓
B17	704 to 716	734 to 746	✓
B18	815 to 830	860 to 875	✓
B19	830 to 845	875 to 890	✓
B20	832 to 862	791 to 821	✓
B21	1447.9 to 1462.9	1495.9 to 1510.9	✓
B22*	3410 to 3490	3510 to 3590	✓
B23*	2000 to 2020	2180 to 2200	✓
B24	1626.5 to 1660.5	1525 to 1559	✓
B25	1850 to 1915	1930 to 1995	✓
B26	814 to 849	859 to 894	✓
B27*	807 to 824	852 to 869	✓
B28	703 to 748	758 to 803	✓
B29		717 to 728	✓
B30	2305 to 2315	2350 to 2360	✓
B31	452.5 to 457.5	462.5 to 467.5	✗
B32		1452 to 1496	✓
B34		2010 to 2025	✓
B35		1850 to 1910	✓
B36		1930 to 1990	✓
B37		1910 to 1930	✓
B38		2570 to 2620	✓
B39		1880 to 1920	✓
B40		2300 to 2400	✓
B41		2496 to 2690	✓
B42		3400 to 3600	✓
B43		3600 to 3800	✓
B45		1447 to 1467	✓
B46		5150 to 5925	✓
B47		5855 to 5925	✓
B48		3550 to 3700	✓
B49		3550 to 3700	✓
B50		1432 to 1517	✓
B51		1427 to 1432	✓
B52		3300 to 3400	✓
B53		2483.5 to 2495	✓
B65	1920 to 2010	2110 to 2200	✓
B66	1710 to 1780	2110 to 2200	✓
B68	698 to 728	753 to 783	✓
B69		2570 to 2620	✓
B70	1695 to 1710	1995 to 2020	✓
B71	663 to 698	617 to 652	✓
B72	451 to 456	461 to 466	✗
B73	450 to 455	460 to 465	✗
B74	1427 to 1470	1475 to 1518	✓
B75		1432 to 1517	✓
B76		1427 to 1432	✓
B77		3300 to 4200	✓
B78		3300 to 3800	✓
B79		4400 to 5000	✓
B85	698 to 716	728 to 746	✓
B87	410 to 415	420 to 425	✗
B88	412 to 417	422 to 427	✗

### 3. Antenna Characteristics

#### 3.1 Test Setup

AUT



Vector Network Analyzer

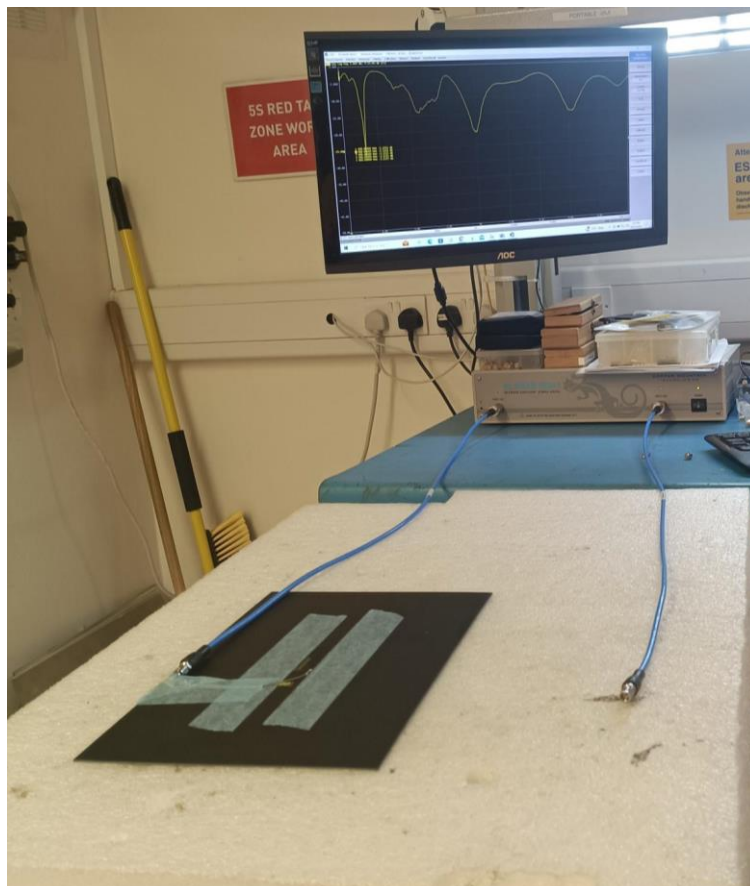

### 3.2 Return Loss

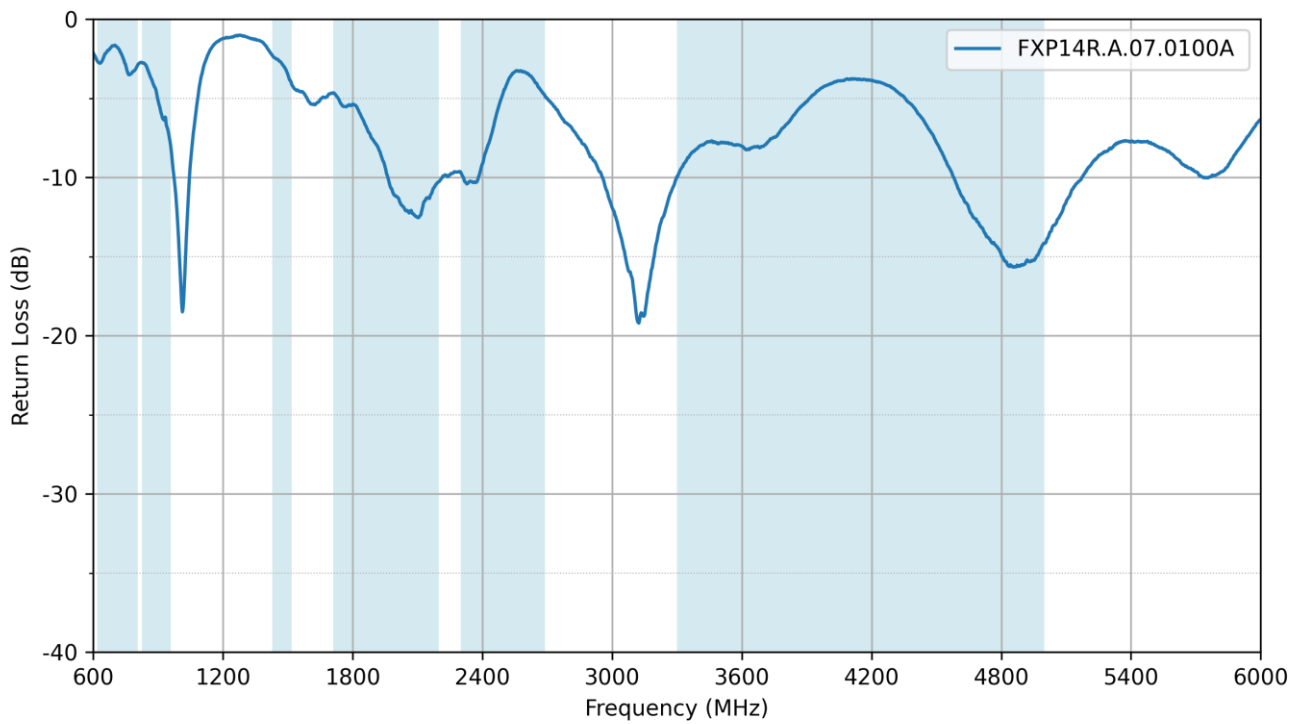

### 3.3 VSWR

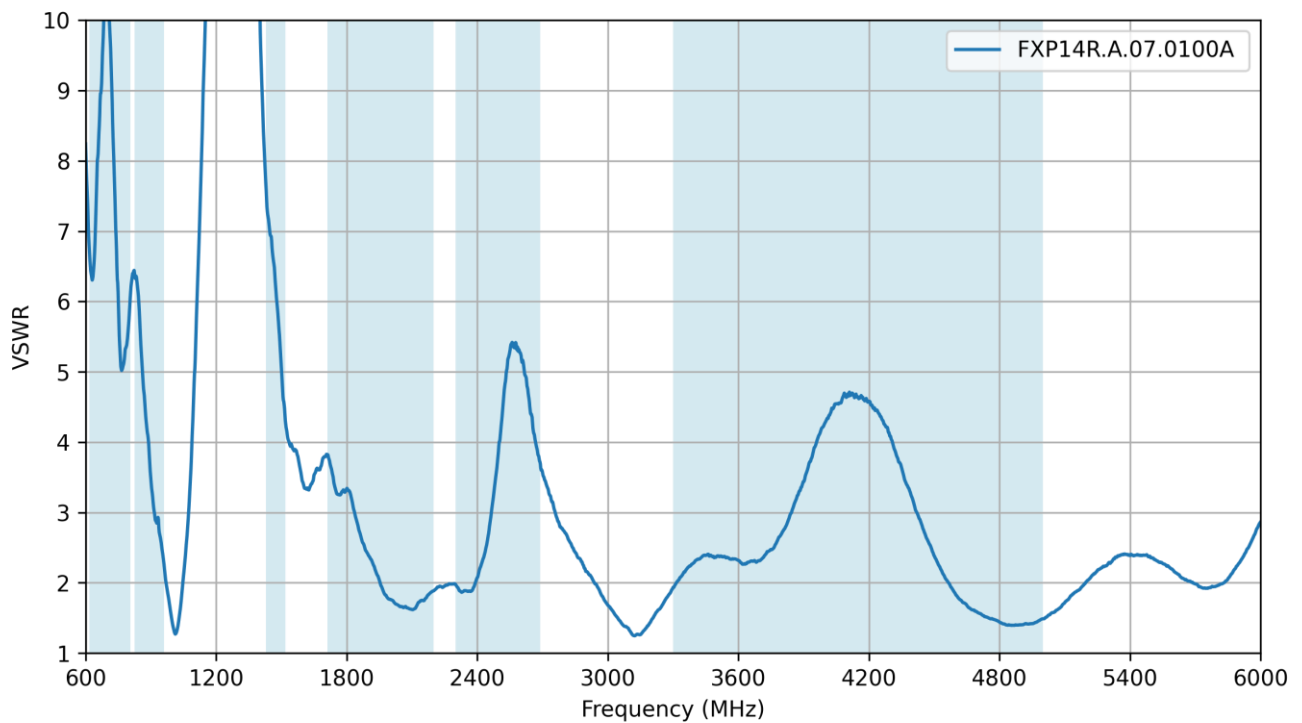

### 3.4 Efficiency

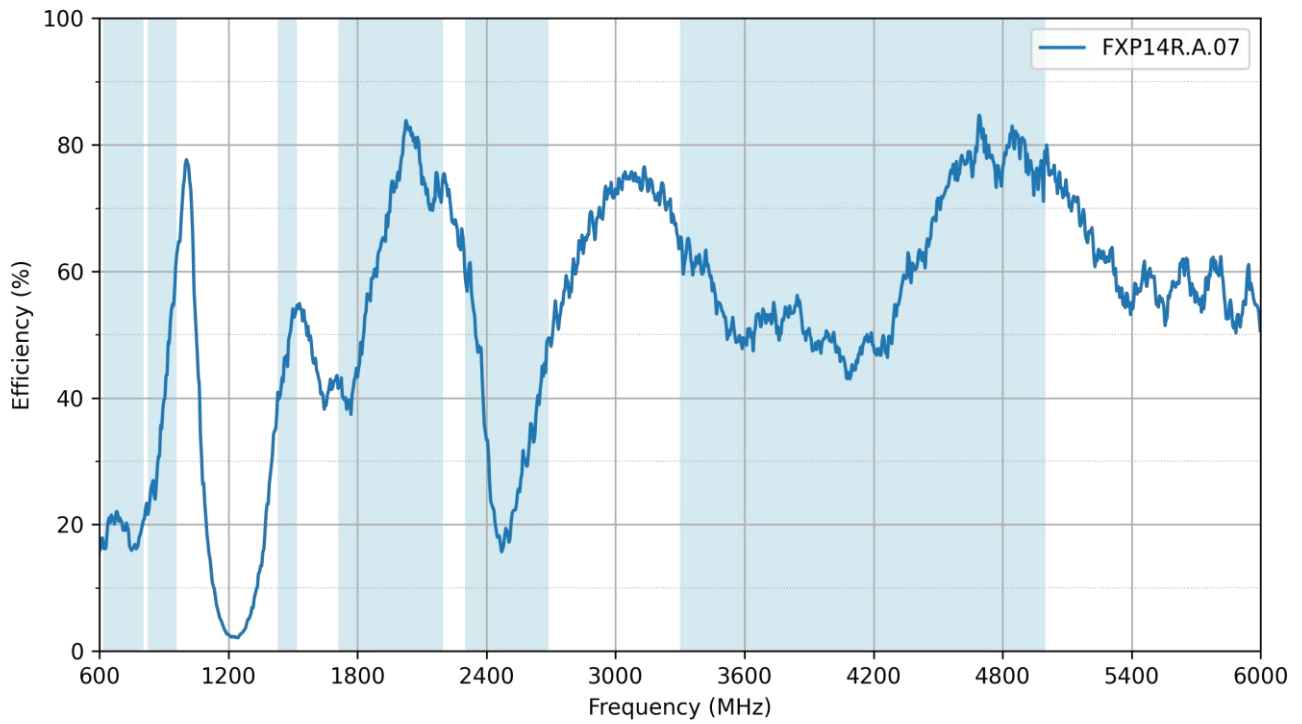

### 3.5 Average Gain

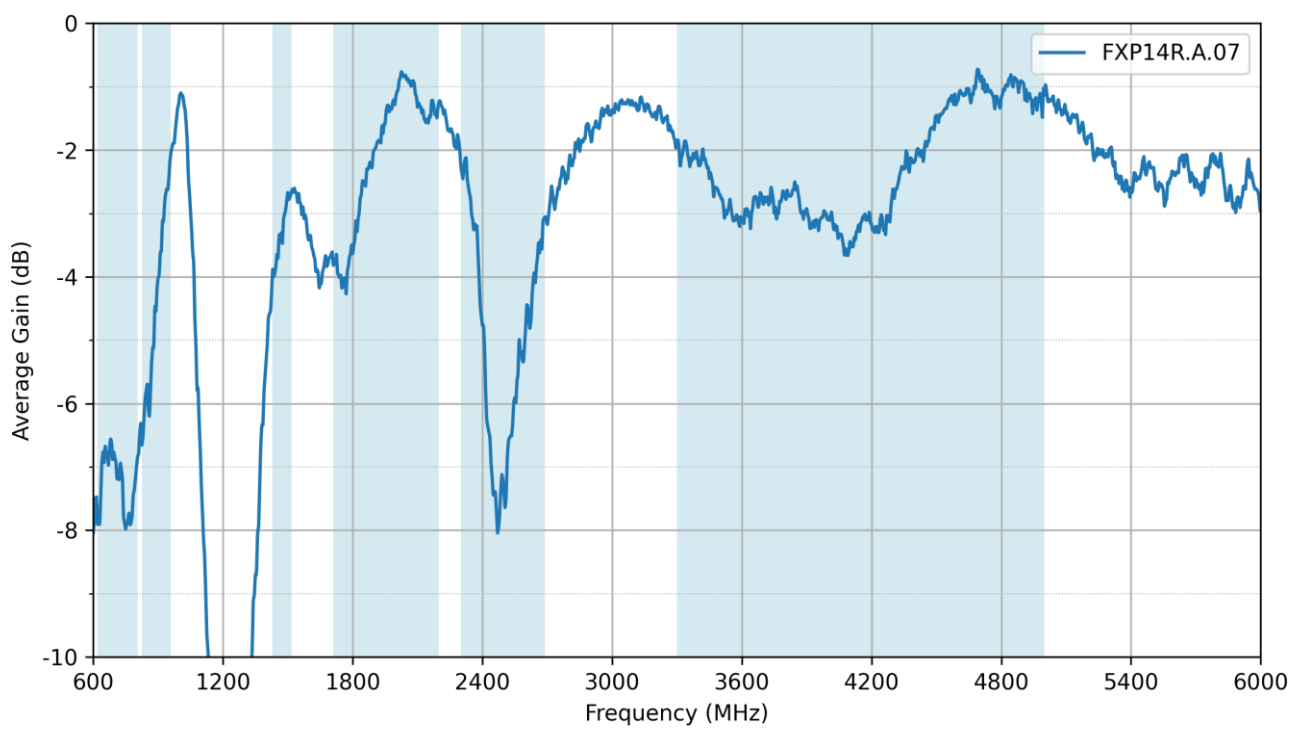



### 3.6 Peak Gain

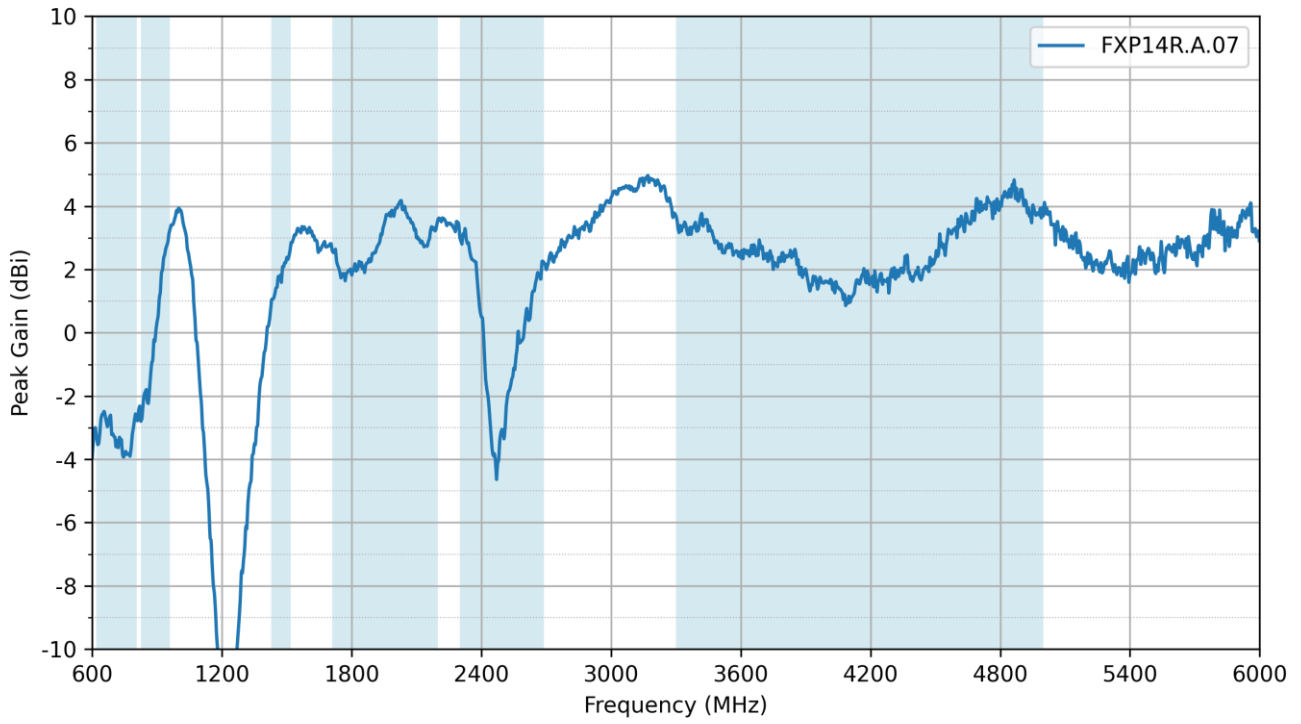

## 4. Radiation Patterns

### 4.1 Test Setup

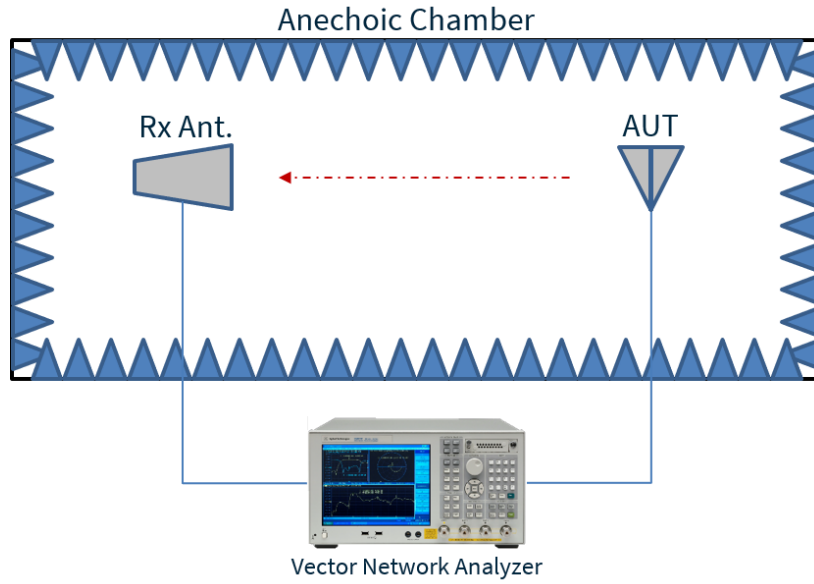

4.2 Patterns at 658 MHz

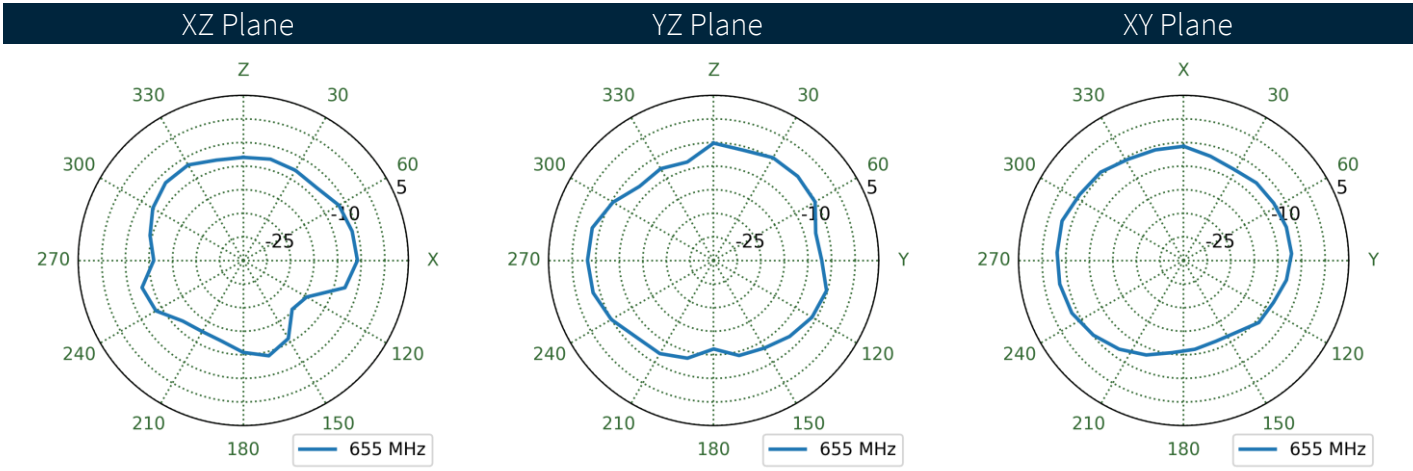
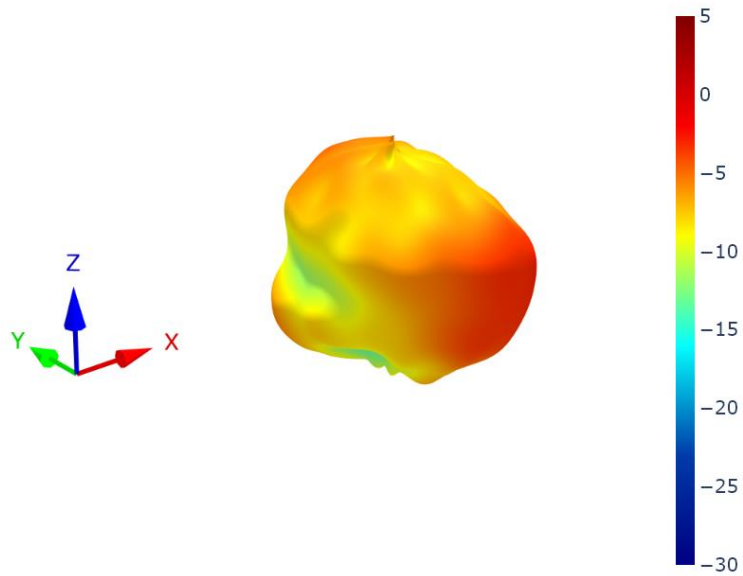

4.3 Patterns at 752 MHz

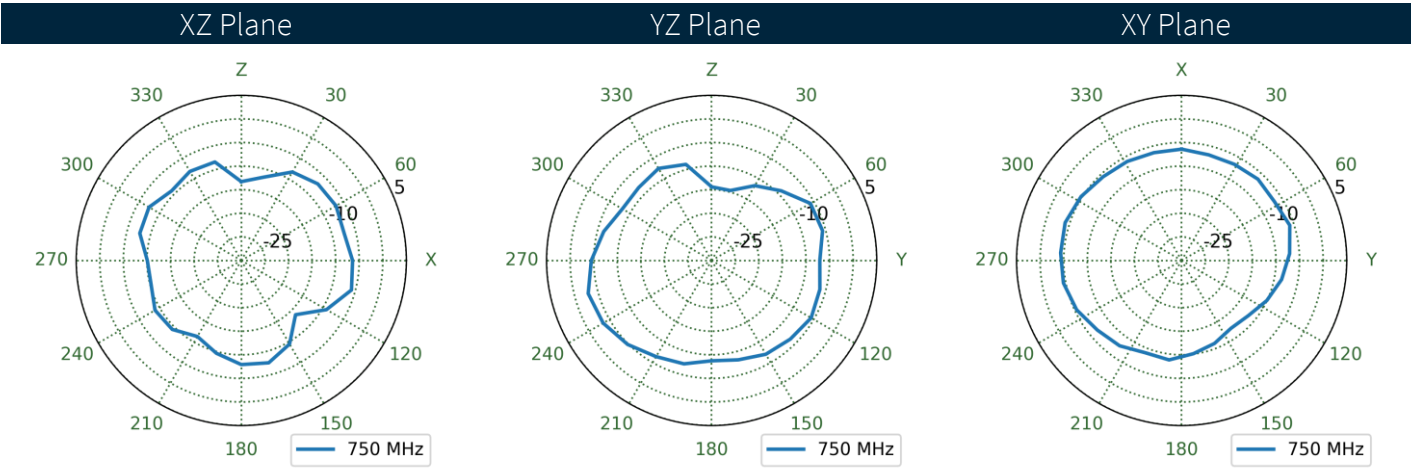
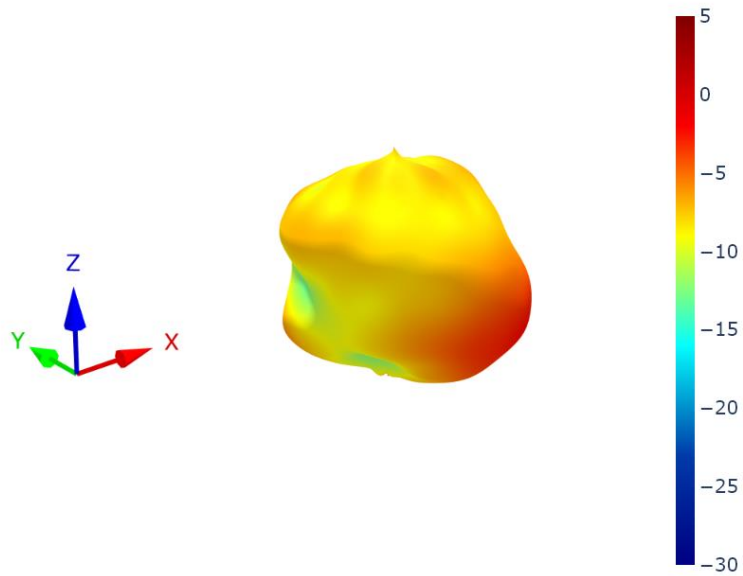

4.4 Patterns at 892 MHz

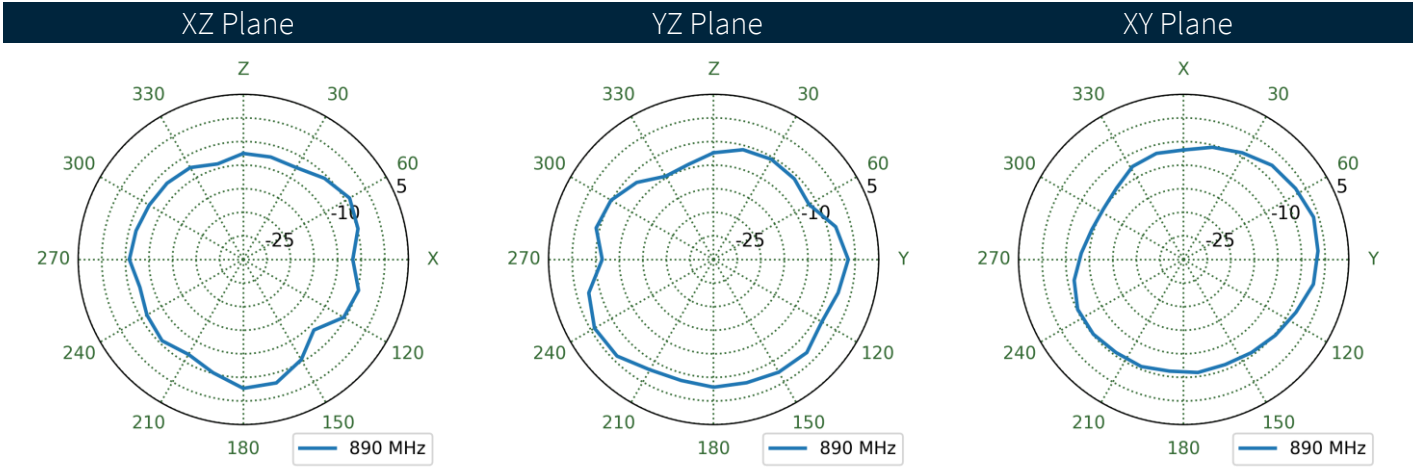
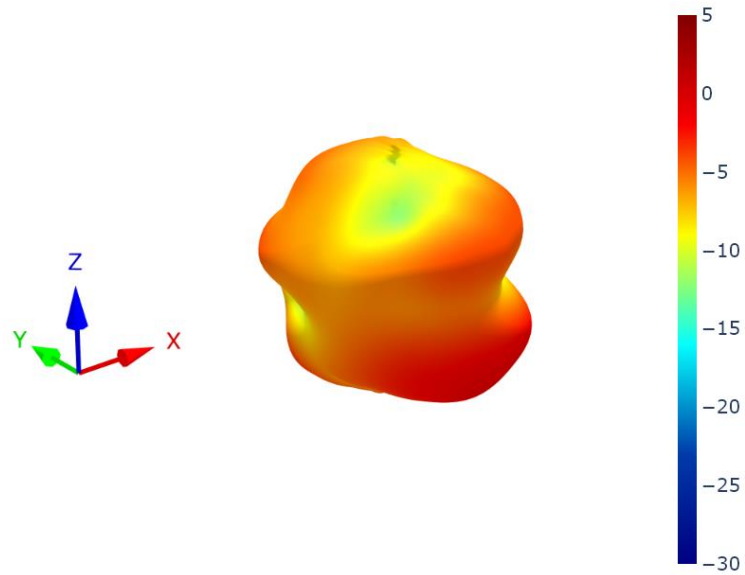

4.5 Patterns at 1473 MHz

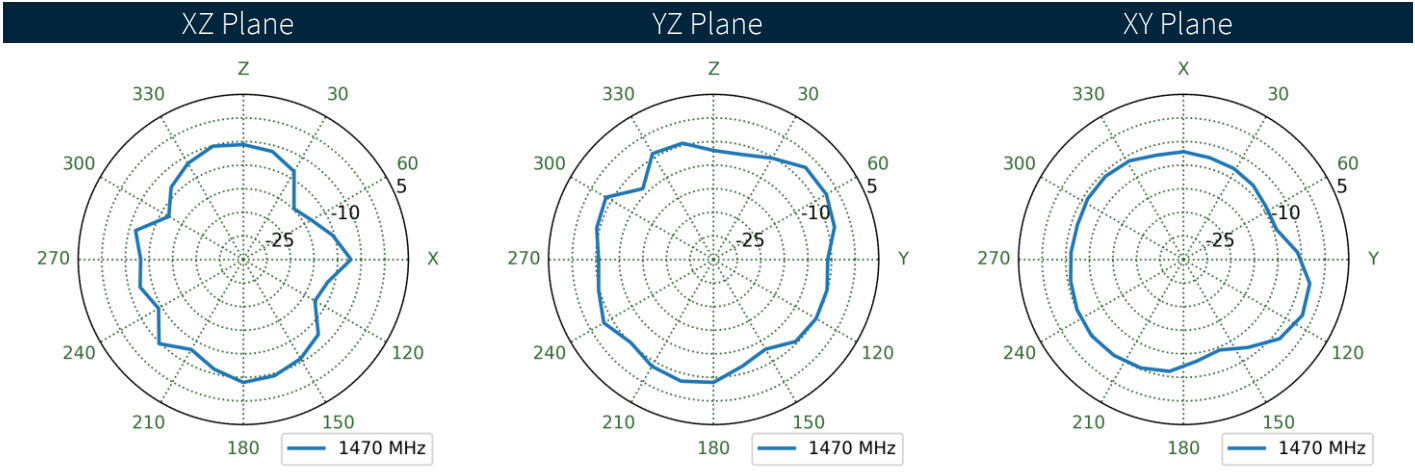
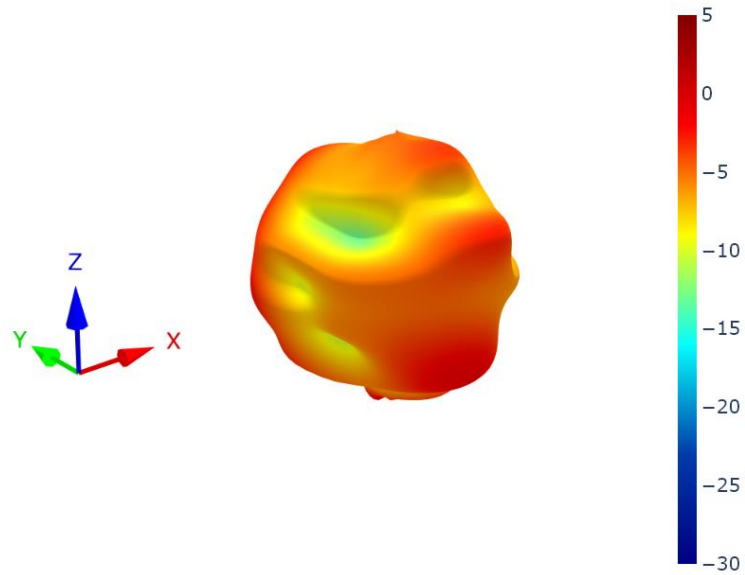

4.6 Patterns at 1955 MHz

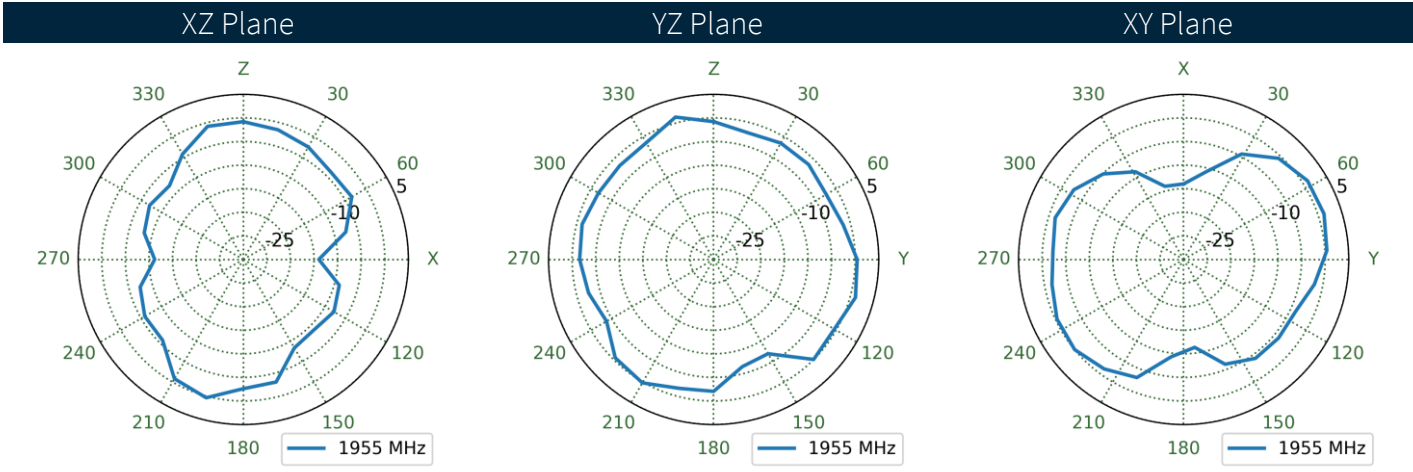
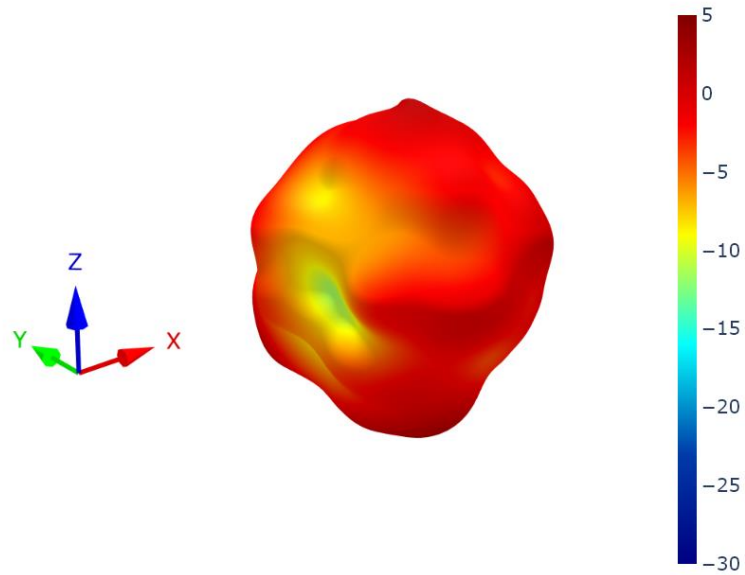

4.7 Patterns at 2495 MHz

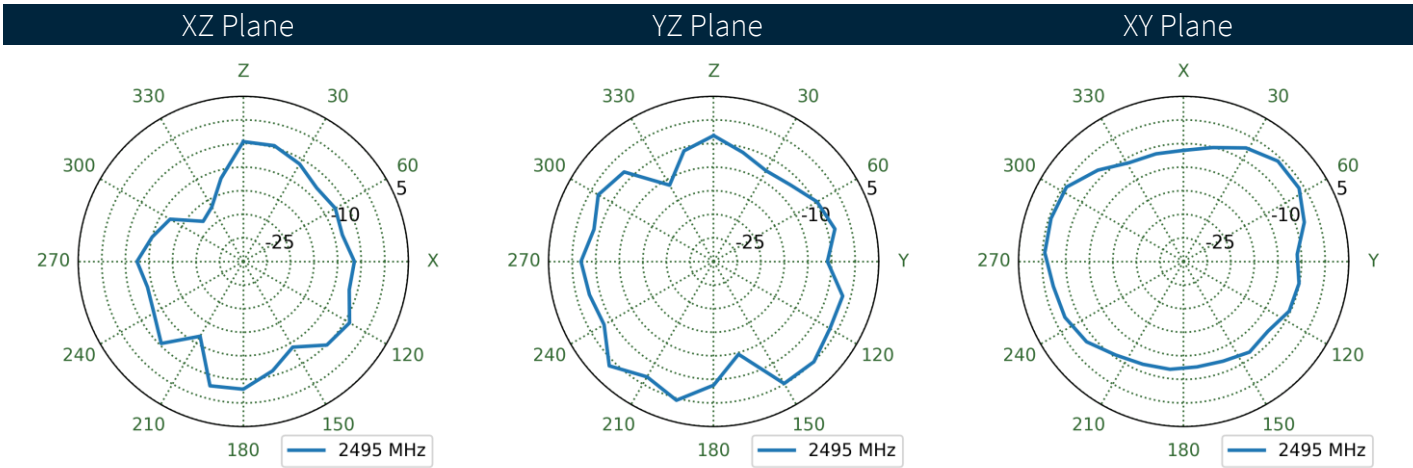
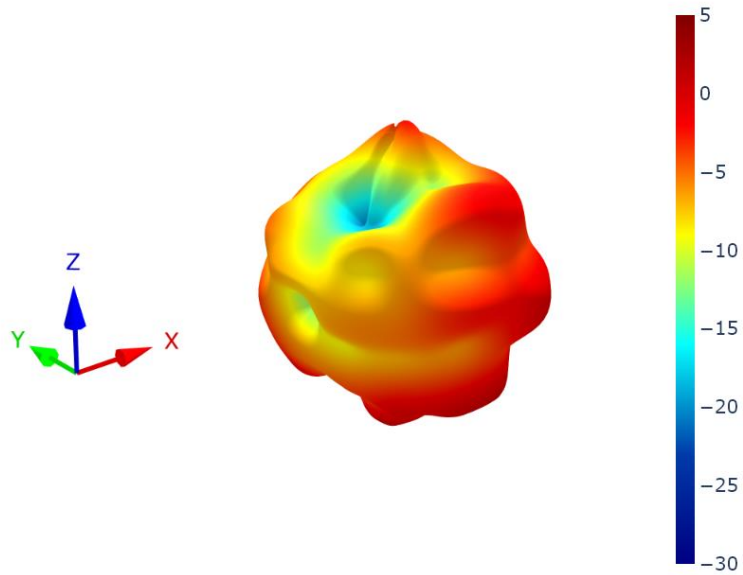



4.8 Patterns at 4150 MHz

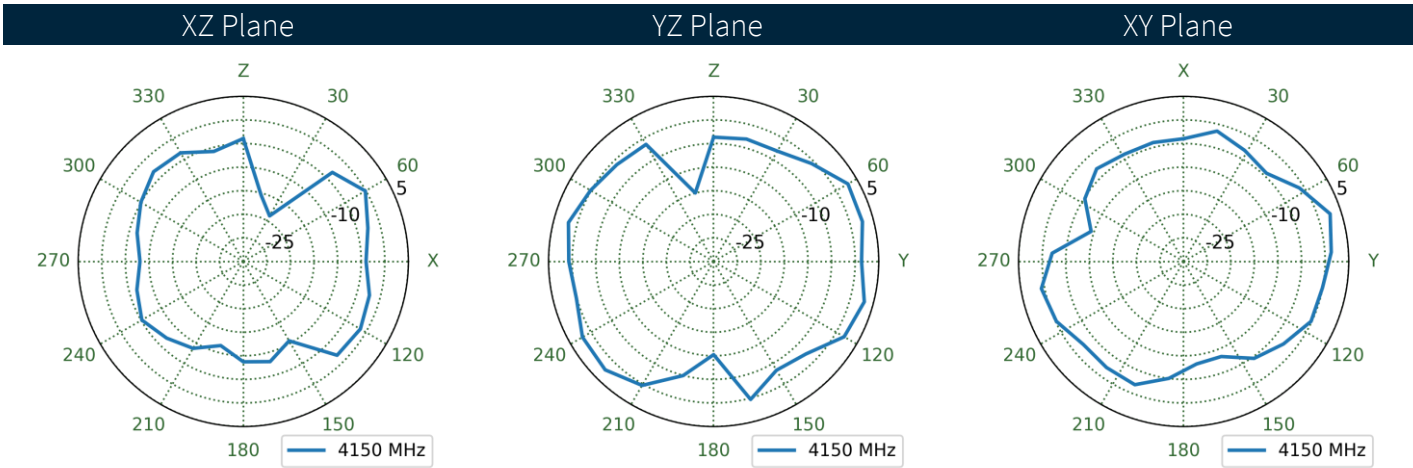
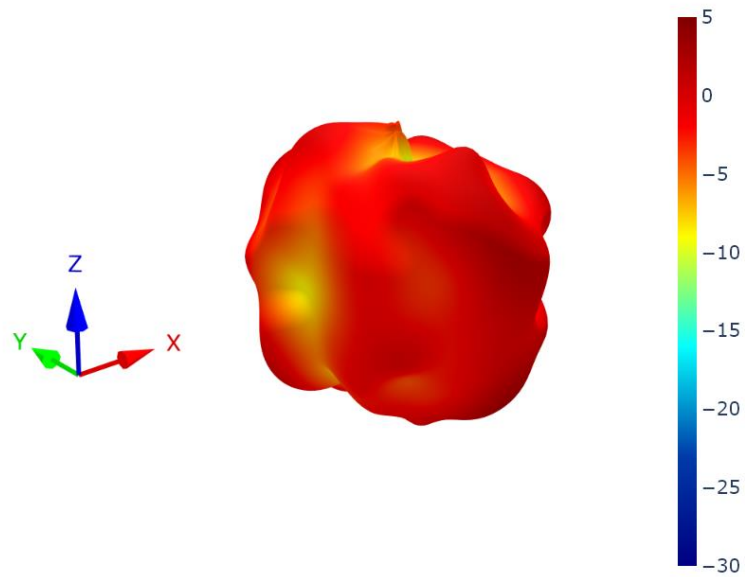

4.9 Patterns at 5538 MHz

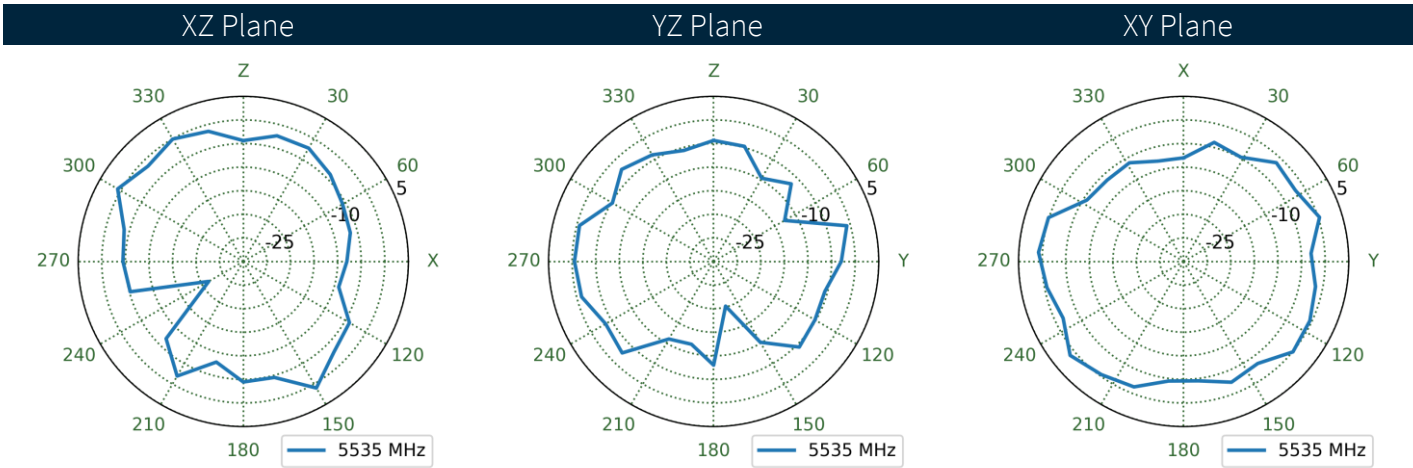
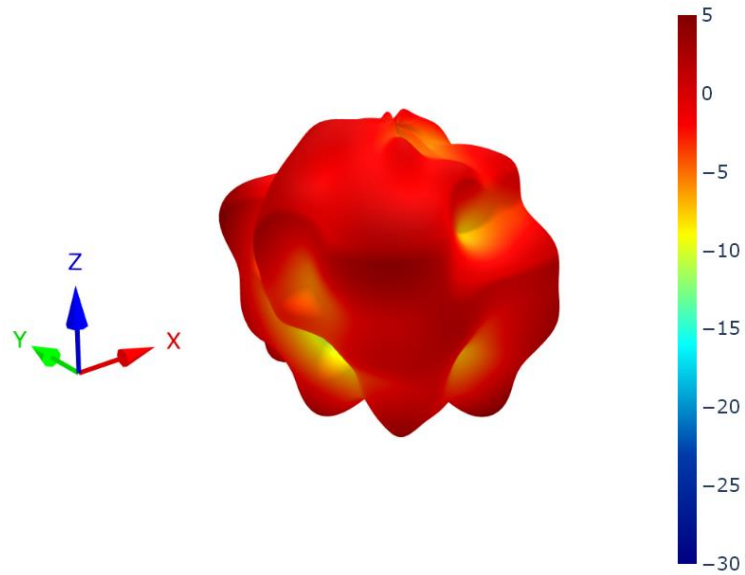

## 5. Mechanical Drawing

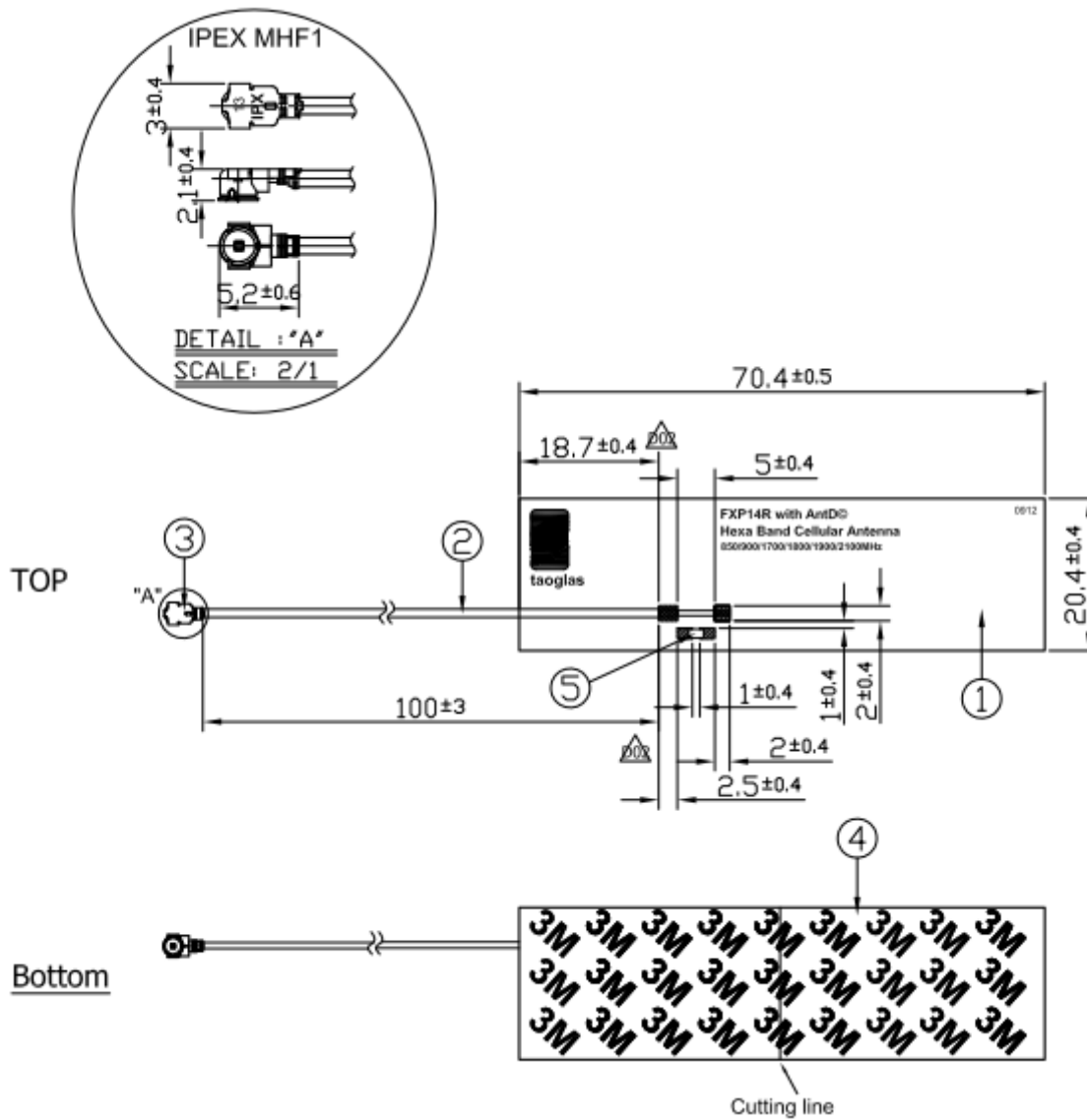
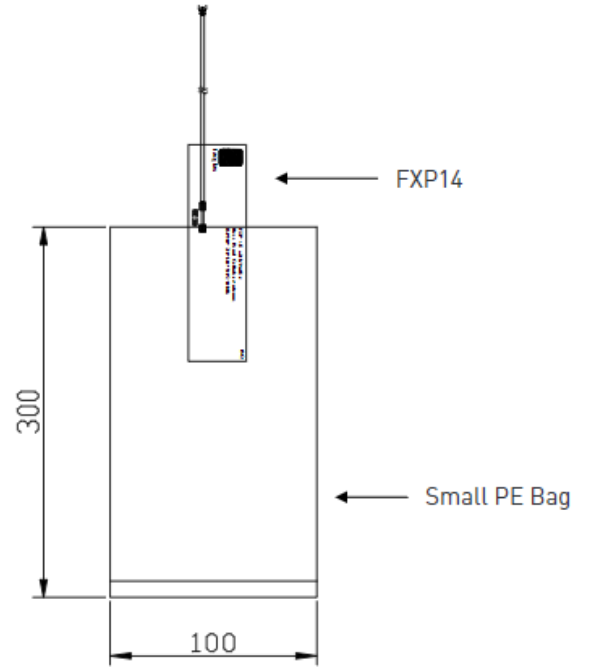

**Figure 9.** Mechanical Drawing for the FXP14 Antenna

	Name	Material	Finish	QTY
①	FXP14R FPCB	FPCB 0.1t	Black	1
②	1.13 Coaxial Cable	FEP	Black	1
③	IPEX MHF1	Brass	Gold	1
④	Double-Sided Adhesive	3M 467	Brown Liner	1
⑤	Resistor (R=10k Ohm)	Ceramic	N/A	1

## 6. Packaging

100pcs FXP14R.07.0100A per PE Bag  
 Dimensions - 300\*100mm  
 Weight - 150g



Changelog for the datasheet

**SPE-13-8-074– FXP14.07.0100A**

**Revision: B (Current Version)**

Date:	2023-11-14
Changes:	Full datasheet update. (New test results showing 600-6000MHz)
Changes Made by:	Aswin Biju

**Previous Revisions**

**Revision: A**

Date:	2013-10-11
Changes:	Initial Release
Changes Made by:	Peter Knaz



[www.taoglas.com](http://www.taoglas.com)

