

Feb. 1. 2024 Copyright 2024 HIROSE ELECTRIC CO., LTD. All Rights Reserved.
 In case of consideration for using Automotive equipment / device which demand high reliability, kindly contact our sales window correspondents.

COUNT	DESCRIPTION OF REVISIONS	BY	CHKD	DATE	COUNT	DESCRIPTION OF REVISIONS	BY	CHKD	DATE
4	DIS-F-000841	S.K	H.O	06.03.07					

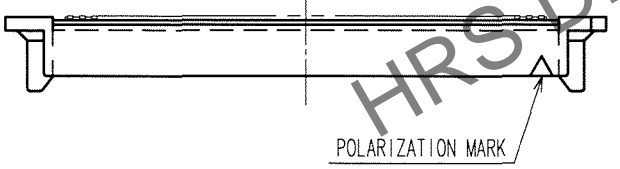

RECOMMENDED P.C.B. LAND PATTERN (MOUNT SIDE)

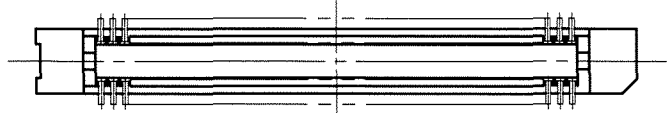
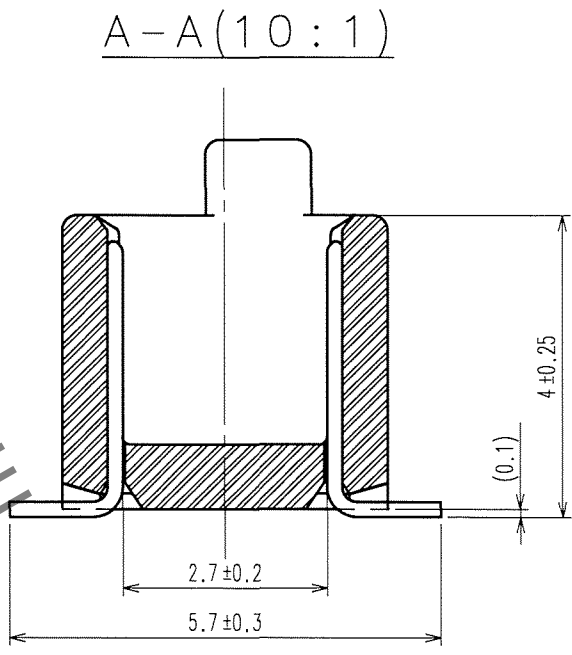
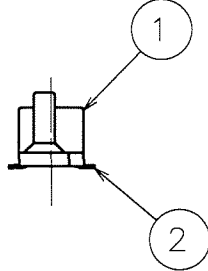
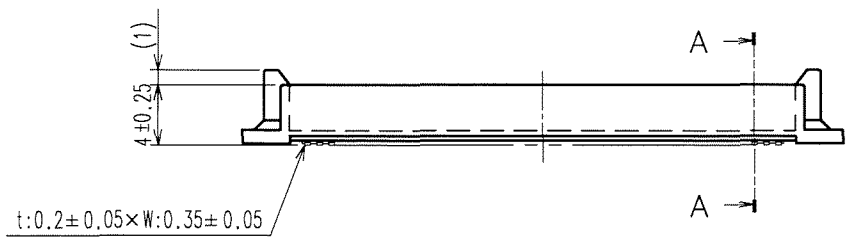
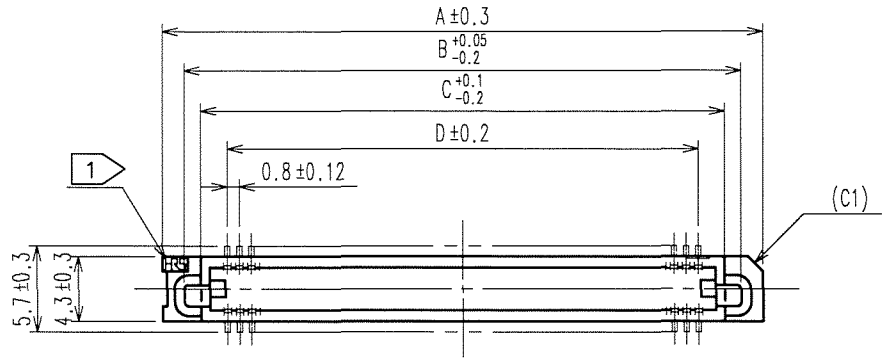
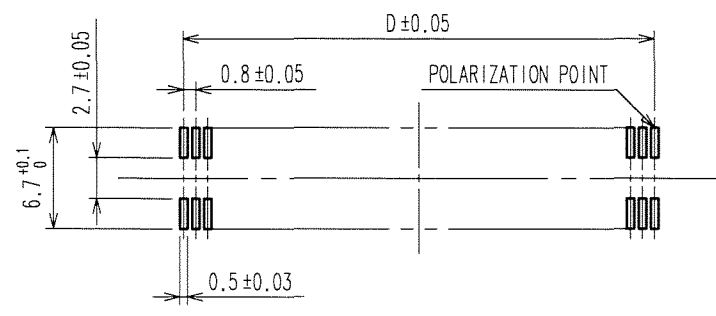

DIMENSION TABLE OF CONNECTOR AND P.C.B. LAND PATTERN.

PART No.	CODE No.	7	8	A	B	C	D
FX6A- 20P-0.8SV(93)	CL576-0201-2-93	20	X	15.8	12.9	10.7	7.2
FX6A- 40P-0.8SV(93)	—	40	—	23.8	20.9	18.7	15.2
FX6A- 50P-0.8SV(93)	CL576-0204-0-93	50	X	27.8	24.9	22.7	19.2
FX6A- 60P-0.8SV(93)	—	60	—	31.8	28.9	26.7	23.2
FX6A- 80P-0.8SV(93)	CL576-0207-9-93	80	X	39.8	36.9	34.7	31.2
FX6A-100P-0.8SV(93)	—	100	—	47.8	44.9	42.7	39.2

- NOTE
- 1 HRS MARK SHALL BE OPTIONAL.
 - 2 LEAD CO-PLANARITY SHALL BE 0.1mm MAX.
 - 3 THE DIMENSIONS IN PARENTHESES ARE FOR REFERENCE.
 - 4 EMBOSSED CARRIER TAPE PACKAGING SHALL BE APPLIED FOR THIS PRODUCT. SEE NEXT PAGE FOR DETAILS.
 - 5 THIS PRODUCT HAS TAPE FOR VACUUM PICKUP. SEE NEXT PAGE FOR DETAIL OF STICKING POSITION, ETC.
 - 6 FOR MODIFICATION, ETC., PREVENTIVE HOLE FOR SINK MARK MAY BE ADDED ACCORDING TO CIRCUMSTANCES.
 - 7 NUMBER OF CONTACTS.
 - 8 PRODUCTS MARKED X ARE AVAILABLE.

1	PPS	LIGHT BROWN (UL94V-0)	2	PHOSPHOR BRONZE	CONTACT AREA: GOLD 0.1μm min. LEAD AREA: GOLD PLATING FLASH UNDER PLATING: NICKEL 1.5μm min.
NO.	MATERIAL	FINISH, REMARKS	NO.	MATERIAL	FINISH, REMARKS

CODE NO. (OLD)	DRAWN	DESIGNED	CHECKED	APPROVED	RELEASED
	T. YANAGISAWA	T. NODA	H. OZAWA	H. OKAWA	
	'05.07.25	'05.08.04	'05.08.04	'05.08.05	

 SCALE FREE UNITS mm	DRAWING NO. EDC3-152946-23 HIROSE ELECTRIC CO., LTD	PART NO. FX6A-*P-0.8SV(93) CODE NO. CL576	1/2
----------------------------------	---	--	-----

