

TDK-Lambda

PXA15-xxWSxx

Single Output 15 Watt DC/DC Converters



The PXA15 series is approved to UL/CSA/EN/IEC 62368-1, 60950-1

Table of contents

Absolute Maximum Rating	P2	Short Circuit Protection	P26
Output Specification	P2	Thermal Consideration	P26
Input Specification	P3	Remote ON/OFF Control	P27
General Specification	P4	Mechanical Data	P28
Characteristic Curves	P5	Recommended Pad Layout	P29
Testing Configurations	P21	Soldering and Reflow Considerations	P30
EMC Consideration	P22	Cleaning and Drying Considerations	P31
Input Source Impedance	P24	Part Number Structure	P32
Output Over Current Protection	P24	Safety and Installation Instruction	P32
Output Over Voltage Protection	P24	MTBF and Reliability	P32
Output Voltage Adjustment	P25		

Absolute Maximum Rating				
Parameter	Model	Min	Max	Unit
Input Voltage	24WSXX 48WSXX		36	V _{DC}
			75	
Transient (100mS)	24WSXX 48WSXX		50	
			100	
Operating Ambient Temperature (with derating)	All	-40	85	°C
Storage Temperature	All	-55	125	°C

Output Specification					
Parameter	Model	Min	Typ	Max	Unit
Output Voltage Range (V _{in} = V _{in} (nom) ; Full Load ; T _A =25 °C)	XXWS3P3	3.267	3.3	3.333	V _{DC}
	XXWS05	4.95	5	5.05	
	XXWS12	11.88	12	12.12	
	XXWS15	14.85	15	15.15	
Voltage Adjustability(See Page 25)	All	-10		+10	%
Output Regulation Line (V _{in} (min) to V _{in} (max) at Full Load) Load (0% to 100% of Full Load)	All	-0.2		+0.2	%
		-0.2		+0.2	
Output Ripple & Noise(See Page 21) Peak-to-Peak (20MHz bandwidth) (Measured with a 1uF M/C and a 10uF T/C)	All		100		mV _{P-P}
Temperature Coefficient	All	-0.02		+0.02	%/ °C
Output Voltage Overshoot (V _{in} (min) to V _{in} (max) ; Full Load ; T _A =25 °C)	All			3	% V _{OUT}
Dynamic Load Response (V _{in} = V _{in} (nom) ; T _A =25 °C) Load step change from 75% to 100% or 100 to 75% of Full Load Peak Deviation Settling Time (V _{OUT} □ 10% peak deviation)	All		300		mV
	All		250		μS
Output Current	XXWS3P3	0		4000	mA
	XXWS05	0		3000	
	XXWS12	0		1300	
	XXWS15	0		1000	
Output Over Voltage Protection (Voltage Clamped)	XXWS3P3	3.7		5.4	V _{DC}
	XXWS05	5.6		7.0	
	XXWS12	13.8		17.5	
	XXWS15	16.8		20.5	
Output Over Current Protection	All		150		% FL.
Output Short Circuit Protection	All	Hiccup, automatic recovery			

Input Specification					
Parameter	Model	Min	Typ	Max	Unit
Operating Input Voltage	24WSXX	9	24	36	V _{DC}
	48WSXX	18	48	75	
Input Current (Maximum value at V _{in} = V _{in} (nom); Full Load)	24WS3P3			680	mA
	24WS05			754	
	24WS12			793	
	24WS15			763	
	48WS3P3			340	
	48WS05			377	
	48WS12			397	
	48WS15			382	
Input Standby Current (Typical value at V _{in} = V _{in} (nom); No Load)	24WS3P3		60		mA
	24WS05		70		
	24WS12		10		
	24WS15		10		
	48WS3P3		40		
	48WS05		40		
	48WS12		10		
	48WS15		10		
Under Voltage Lockout Turn-on Threshold	24WSXX			9	V _{DC}
	48WSXX			18	
Under Voltage Lockout Turn-off Threshold	24WSXX		8		V _{DC}
	48WSXX		16		
Input Reflected Ripple Current (See Page 21) (5 to 20MHz, 12μH source impedance)	All		30		mA _{P-P}
Start Up Time (V _{in} = V _{in} (nom) and constant resistive load)					mS
	Power up	All	30		
	Remote ON/OFF		30		
Remote ON/OFF Control (See Page 27) (The ON/OFF pin voltage is referenced to -V _{IN})					V _{DC}
	Negative Logic DC-DC ON(Short)	All	0	1.2	
	DC-DC OFF(Open)		3	15	
	Positive Logic DC-DC ON(Open)		3	15	
DC-DC OFF(Short)		0	1.2		
Remote Off Input Current	All		2.5		mA
Input Current of Remote Control Pin	All	-0.5		1.0	mA

General Specification					
Parameter	Model	Min	Typ	Max	Unit
Efficiency(See Page 21) ($V_{in} = V_{in(nom)}$; Full Load ; $T_A=25\text{ }^\circ\text{C}$)	24WS3P3		85		%
	24WS05		87		
	24WS12		86		
	24WS15		86		
	48WS3P3		85		
	48WS05		87		
	48WS12		86		
	48WS15		86		
Isolation Voltage Input to Output	All	2250			V _{DC}
Isolation Resistance	All	1			GΩ
Isolation Capacitance	All			1000	pF
Switching Frequency	XXWS3P3		350		KHz
	XXWS05		350		
	XXWS12		400		
	XXWS15		400		
Weight	All		10.5		g
MTBF(See Page 32) Bellcore TR-NWT-000332, $T_C=40\text{ }^\circ\text{C}$ MIL-HDBK-217F	All		1.322×10^6		hours
			5.147×10^5		

Characteristic Curves

All test conditions are at 25 °C. PXA15-24WS3P3

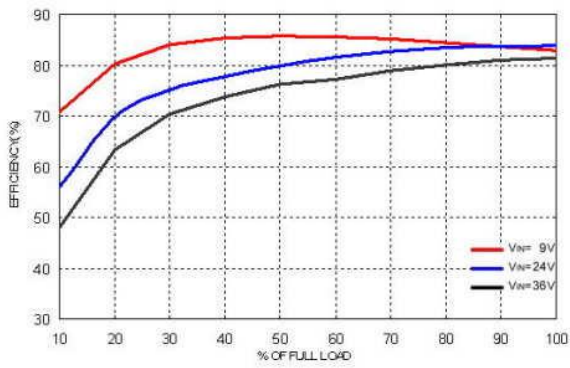

Efficiency versus Output Current

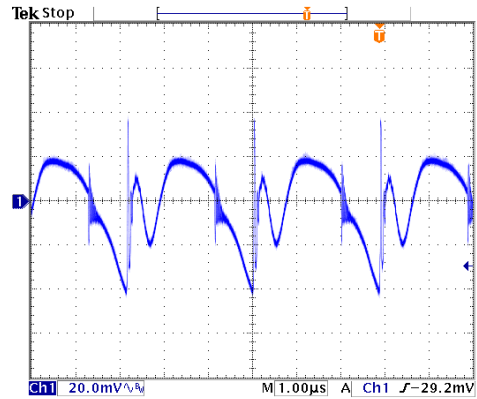

Typical Output Ripple and Noise.
Vin = Vin(nom) ; Full Load

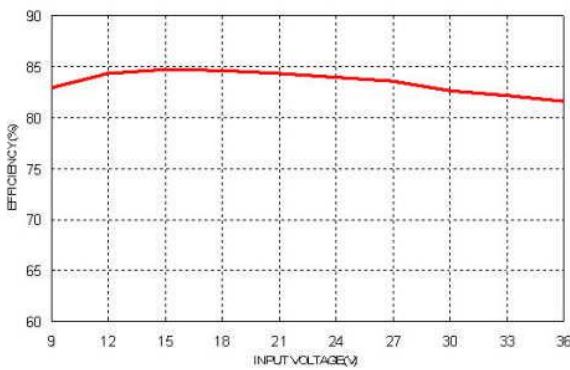

Efficiency versus Input Voltage, Full Load

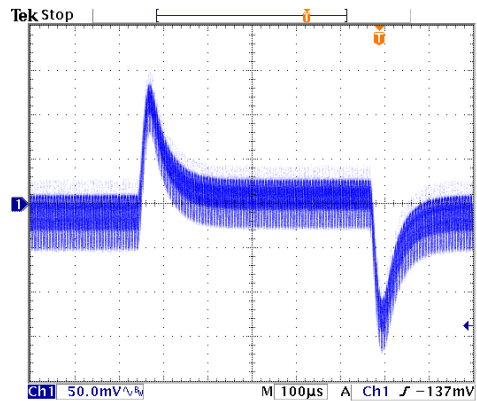

Transient Response to Dynamic Load Change from
100% to 75% to 100% of Full Load ; Vin = Vin(nom)

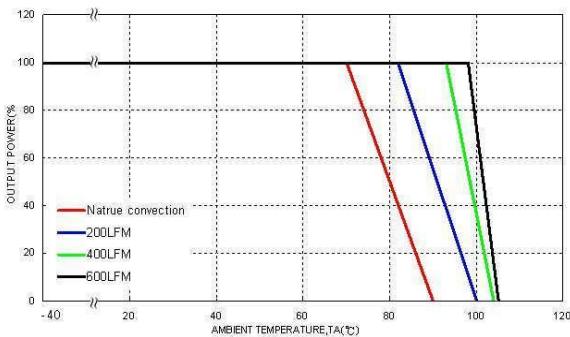

Derating Output Current versus Ambient Temperature and Airflow
Vin = Vin(nom)

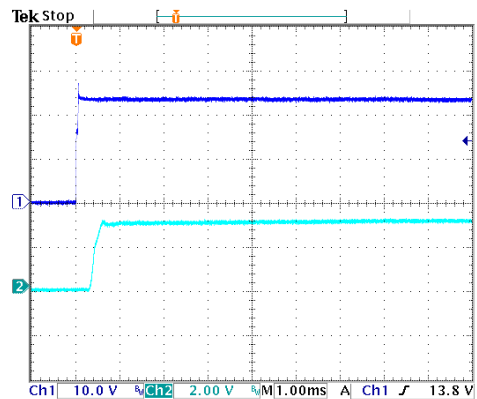

Typical Input Start-Up and Output Rise Characteristic
Vin = Vin(nom) ; Full Load

Characteristic Curves (Continued)

All test conditions are at 25 °C. PXA15-24WS3P3

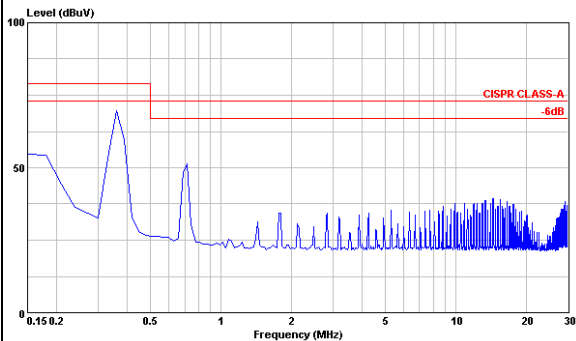

Conduction Emission of EN55022 Class A
 $V_{in} = V_{in(nom)}$; Full Load

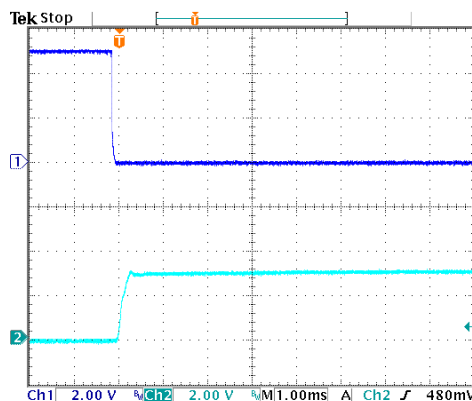

Using ON/OFF Voltage Start-Up and V_o Rise Characteristic
 $V_{in} = V_{in(nom)}$; Full Load

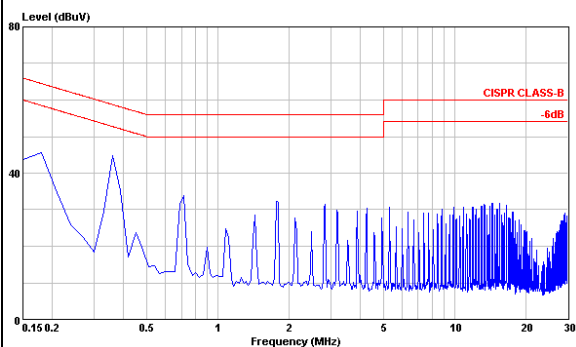

Conduction Emission of EN55022 Class B
 $V_{in} = V_{in(nom)}$; Full Load

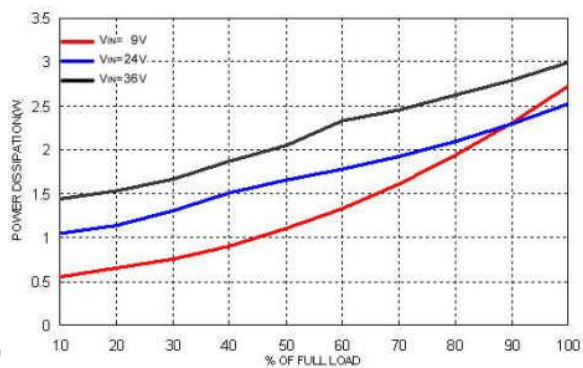

Power Dissipation versus Output Current

Characteristic Curves (Continued)

All test conditions are at 25 °C. PXA15-24WS05

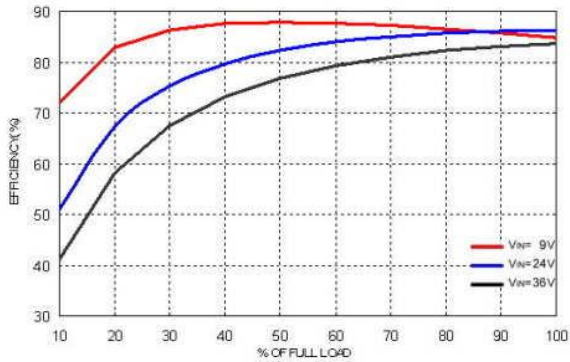

Efficiency versus Output Current

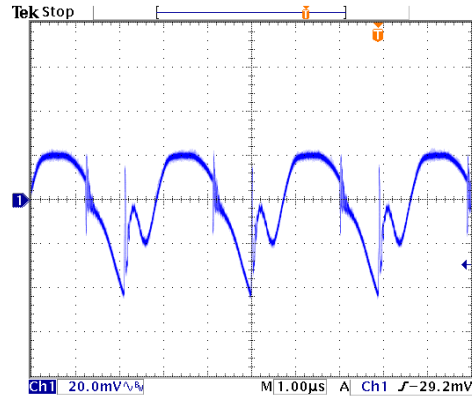

Typical Output Ripple and Noise.

Vin = Vin(nom) ; Full Load

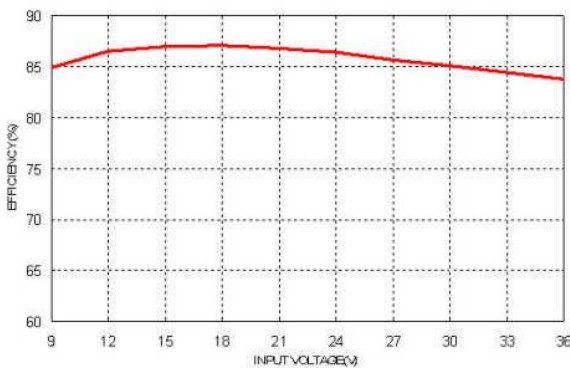

Efficiency versus Input Voltage, Full Load

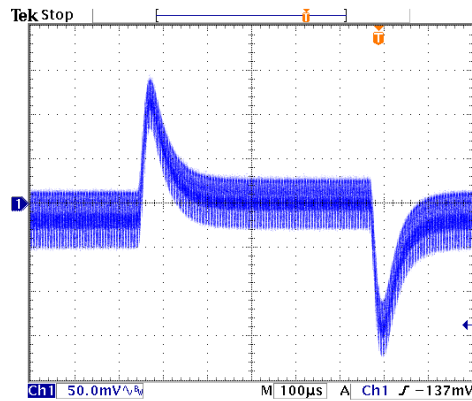

Transient Response to Dynamic Load Change from 100% to 75% to 100% of Full Load ; Vin = Vin(nom)

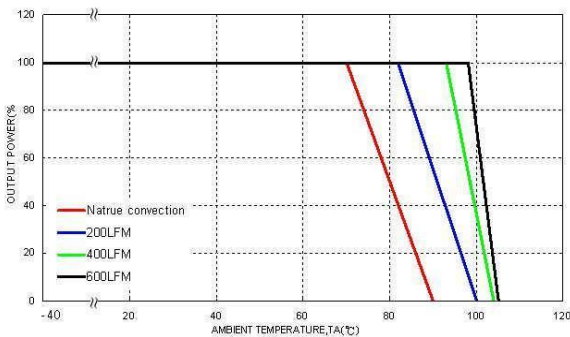

Derating Output Current versus Ambient Temperature and Airflow
Vin = Vin(nom)

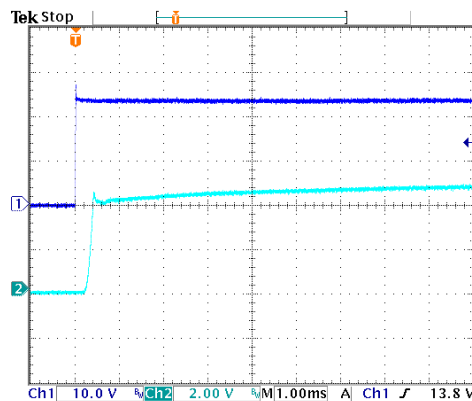

Typical Input Start-Up and Output Rise Characteristic
Vin = Vin(nom) ; Full Load

Characteristic Curves (Continued)

All test conditions are at 25 °C. PXA15-24WS05

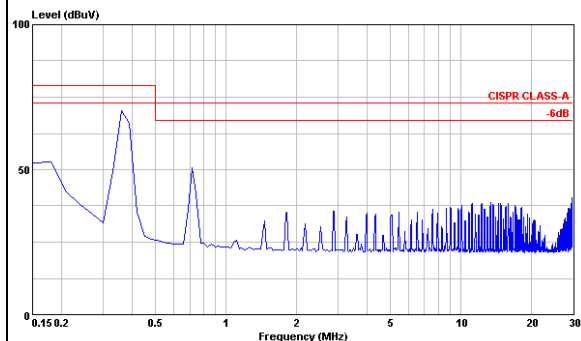

Conduction Emission of EN55022 Class A
 $V_{in} = V_{in(nom)}$; Full Load

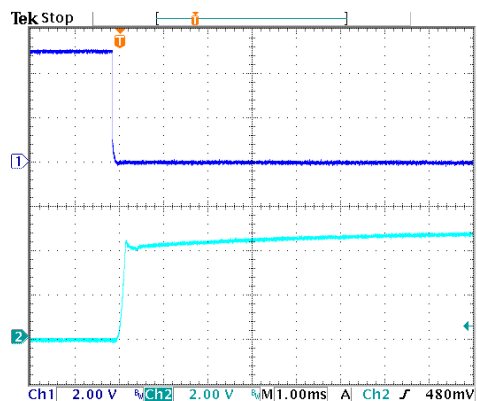

Using ON/OFF Voltage Start-Up and V_o Rise Characteristic
 $V_{in} = V_{in(nom)}$; Full Load

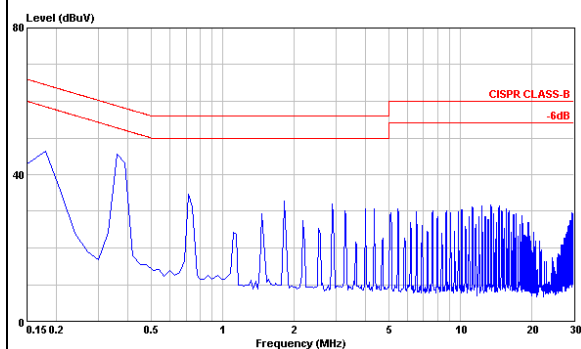

Conduction Emission of EN55022 Class B
 $V_{in} = V_{in(nom)}$; Full Load

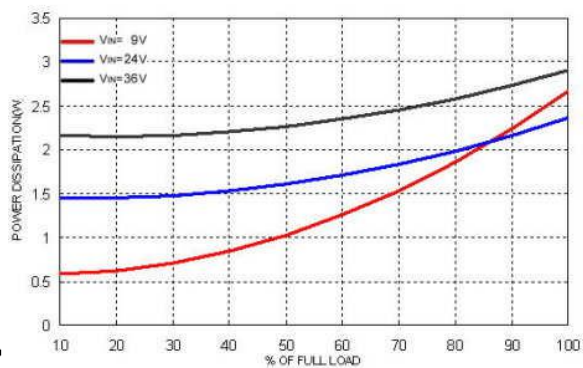

Power Dissipation versus Output Current

Characteristic Curves (Continued)

All test conditions are at 25 °C. PXA15-24WS12

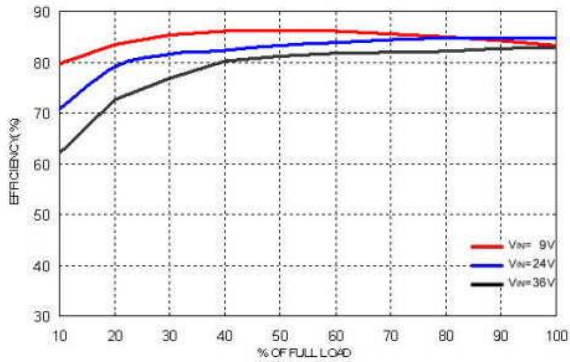

Efficiency versus Output Current

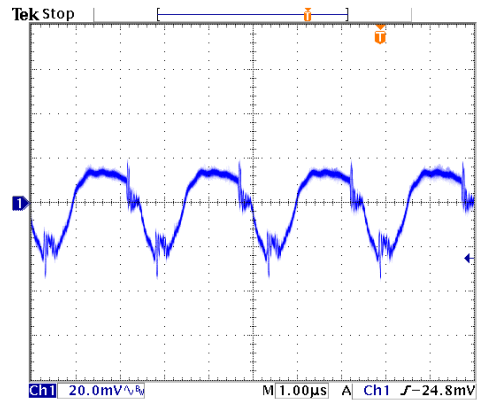

Typical Output Ripple and Noise.

Vin = Vin(nom) ; Full Load

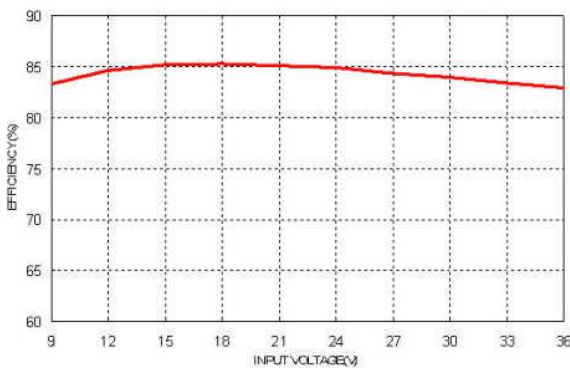

Efficiency versus Input Voltage, Full Load

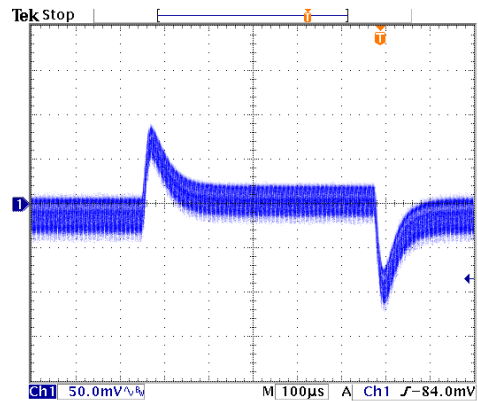

Transient Response to Dynamic Load Change from 100% to 75% to 100% of Full Load ; Vin = Vin(nom)

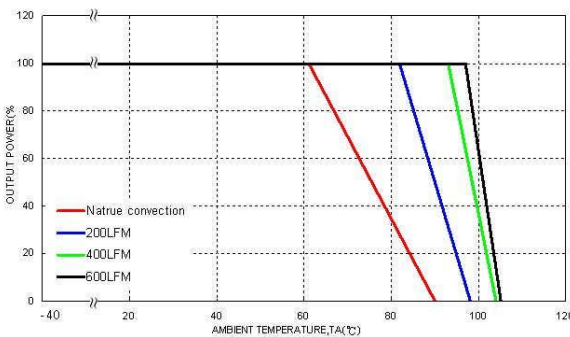

Derating Output Current versus Ambient Temperature and Airflow

Vin = Vin(nom)

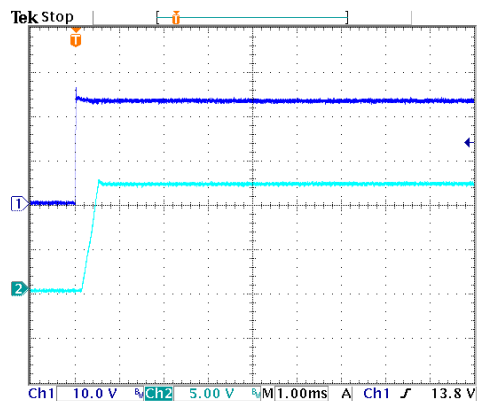

Typical Input Start-Up and Output Rise Characteristic

Vin = Vin(nom) ; Full Load

Characteristic Curves (Continued)

All test conditions are at 25 °C. PXA15-24WS12

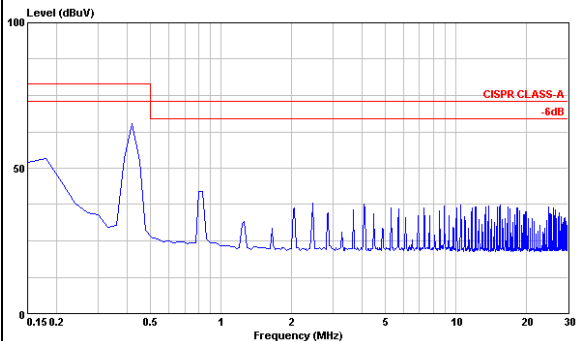

Conduction Emission of EN55022 Class A
 $V_{in} = V_{in(nom)}$; Full Load

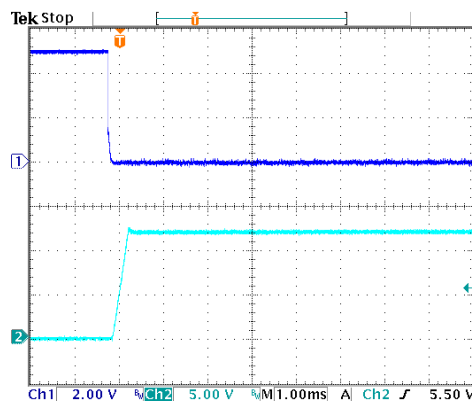

Using ON/OFF Voltage Start-Up and V_o Rise Characteristic
 $V_{in} = V_{in(nom)}$; Full Load

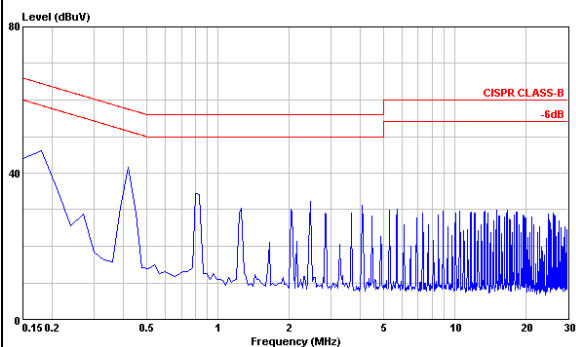

Conduction Emission of EN55022 Class B
 $V_{in} = V_{in(nom)}$; Full Load

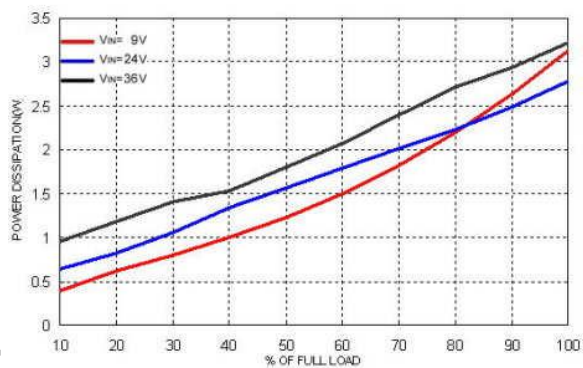

Power Dissipation versus Output Current

Characteristic Curves (Continued)

All test conditions are at 25 °C. PXA15-24WS15

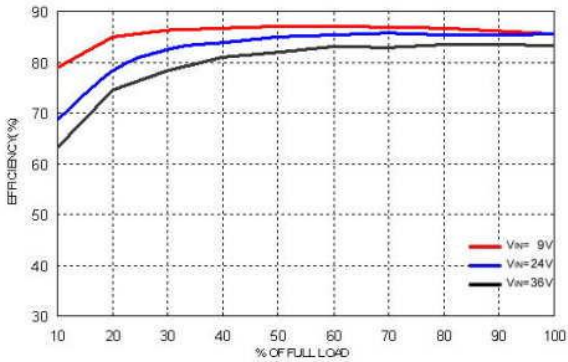

Efficiency versus Output Current

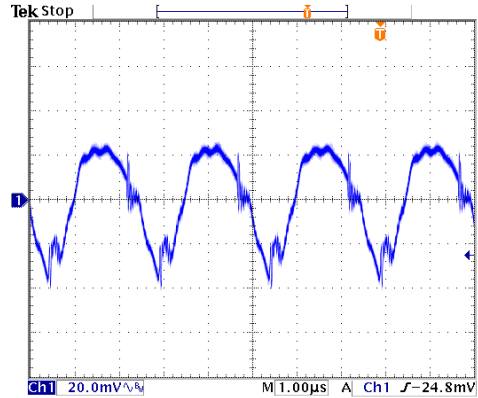

Typical Output Ripple and Noise.

Vin = Vin(nom) ; Full Load

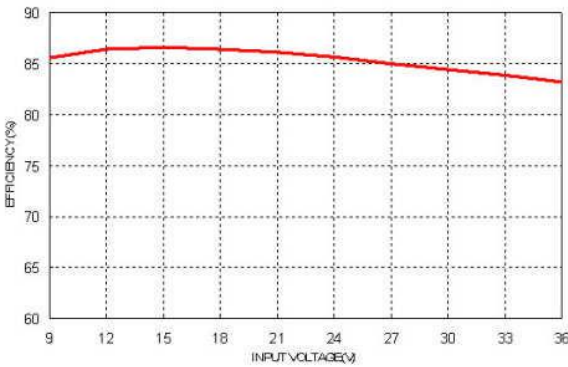

Efficiency versus Input Voltage, Full Load

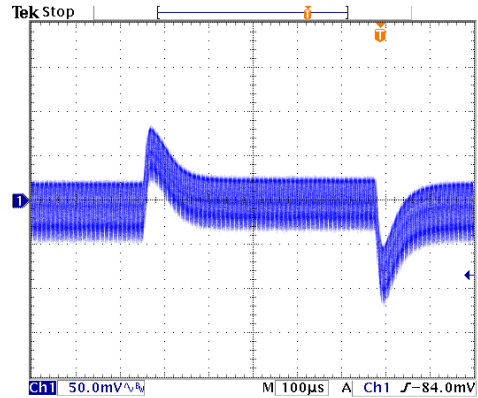

Transient Response to Dynamic Load Change from 100% to 75% to 100% of Full Load ; Vin = Vin(nom)

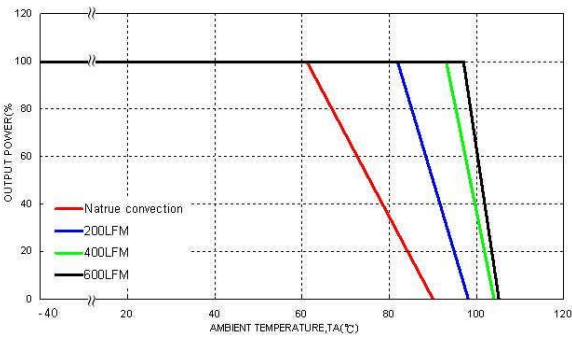

Derating Output Current versus Ambient Temperature and Airflow
Vin = Vin(nom)

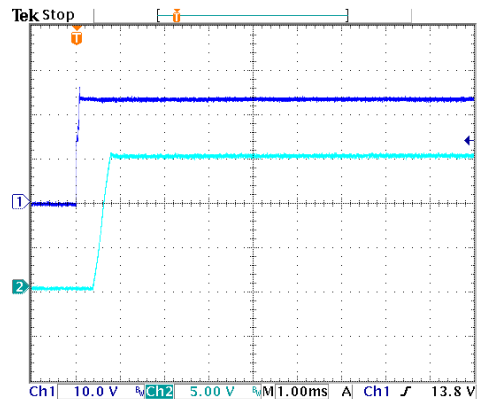

Typical Input Start-Up and Output Rise Characteristic
Vin = Vin(nom) ; Full Load

Characteristic Curves (Continued)

All test conditions are at 25 °C. PXA15-24WS15

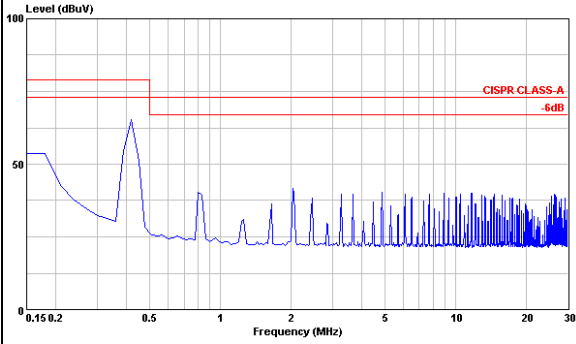

Conduction Emission of EN55022 Class A
 $V_{in} = V_{in(nom)}$; Full Load

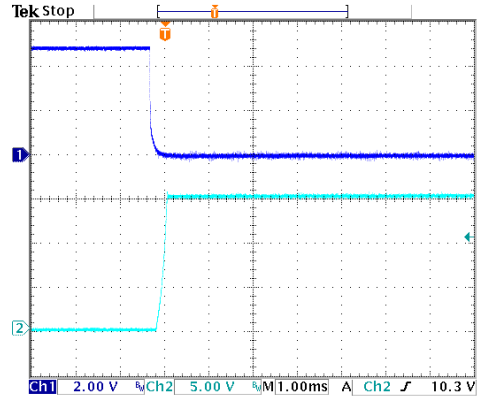

Using ON/OFF Voltage Start-Up and V_o Rise Characteristic
 $V_{in} = V_{in(nom)}$; Full Load

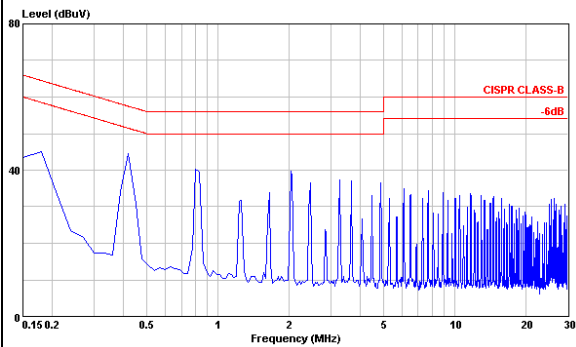

Conduction Emission of EN55022 Class B
 $V_{in} = V_{in(nom)}$; Full Load

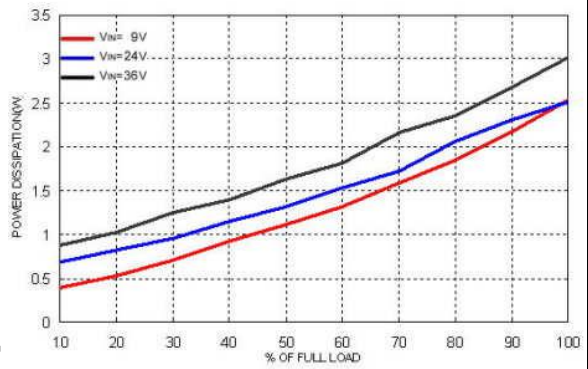

Power Dissipation versus Output Current

Characteristic Curves (Continued)

All test conditions are at 25 °C. PXA15-48WS3P3

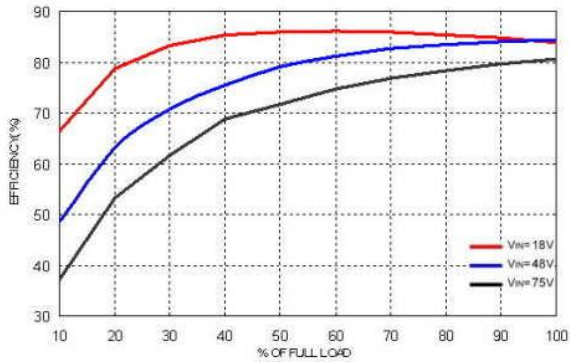

Efficiency versus Output Current

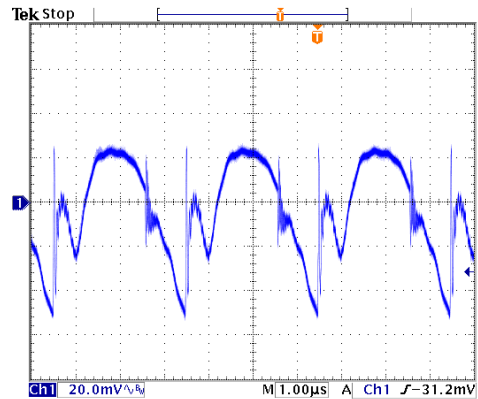

Typical Output Ripple and Noise.

Vin = Vin(nom) ; Full Load

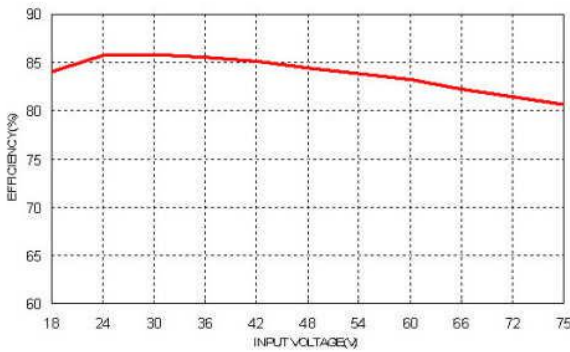

Efficiency versus Input Voltage, Full Load

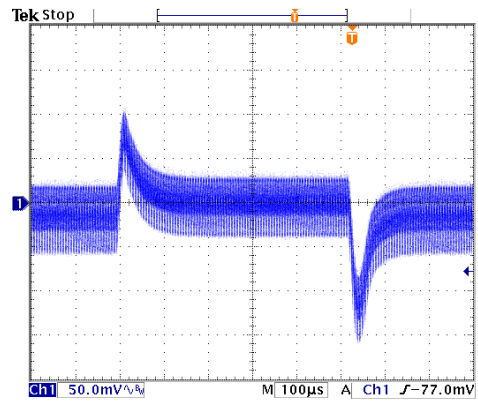

Transient Response to Dynamic Load Change from 100% to 75% to 100% of Full Load ; Vin = Vin(nom)

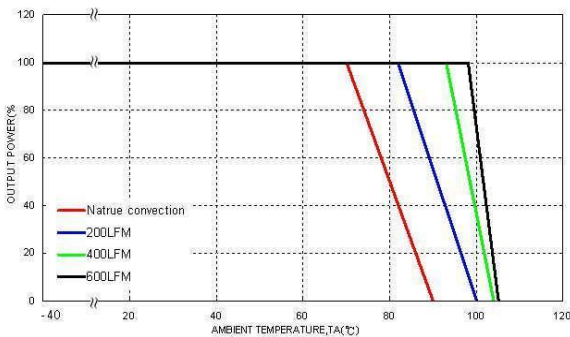

Derating Output Current versus Ambient Temperature and Airflow
Vin = Vin(nom)

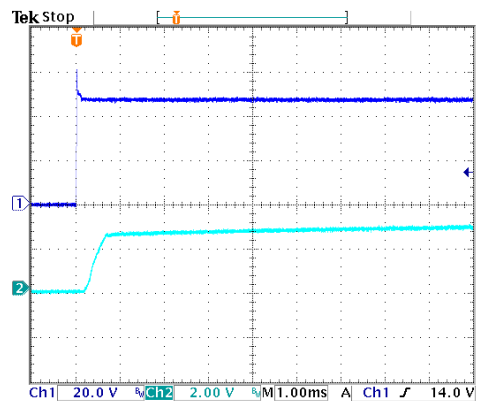

Typical Input Start-Up and Output Rise Characteristic
Vin = Vin(nom) ; Full Load

Characteristic Curves (Continued)

All test conditions are at 25 °C. PXA15-48WS3P3

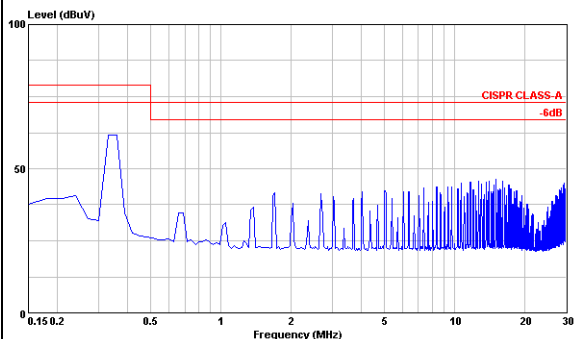

Conduction Emission of EN55022 Class A
 $V_{in} = V_{in(nom)}$; Full Load

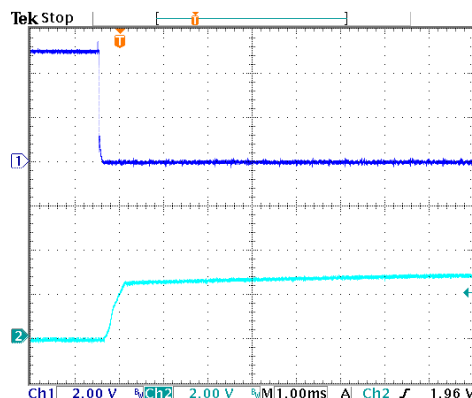

Using ON/OFF Voltage Start-Up and V_o Rise Characteristic
 $V_{in} = V_{in(nom)}$; Full Load

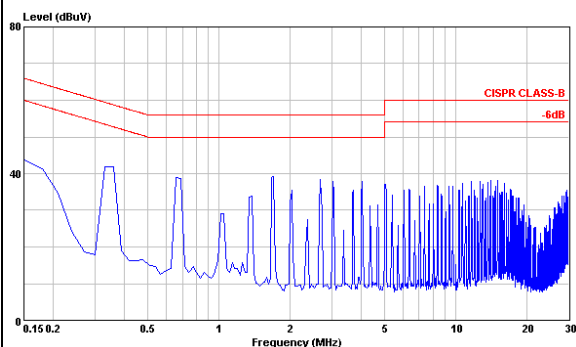

Conduction Emission of EN55022 Class B
 $V_{in} = V_{in(nom)}$; Full Load

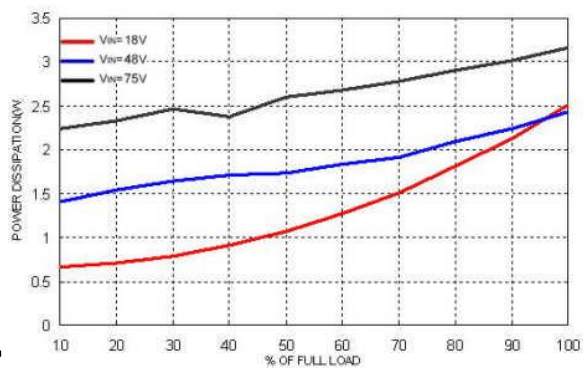

Power Dissipation versus Output Current

Characteristic Curves (Continued)

All test conditions are at 25 °C. PXA15-48WS05

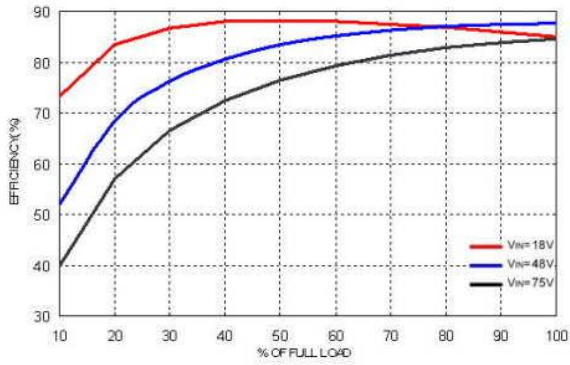

Efficiency versus Output Current

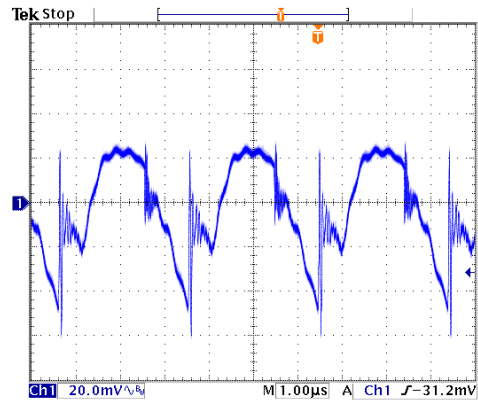

Typical Output Ripple and Noise.
Vin = Vin(nom) ; Full Load

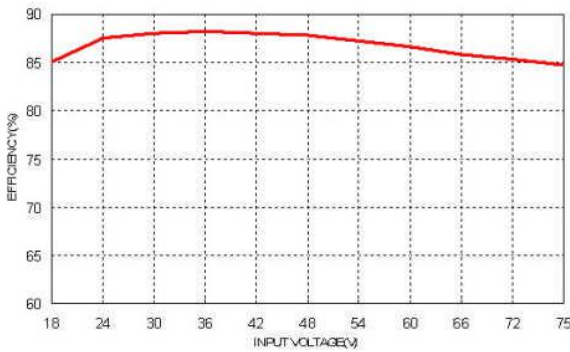

Efficiency versus Input Voltage, Full Load

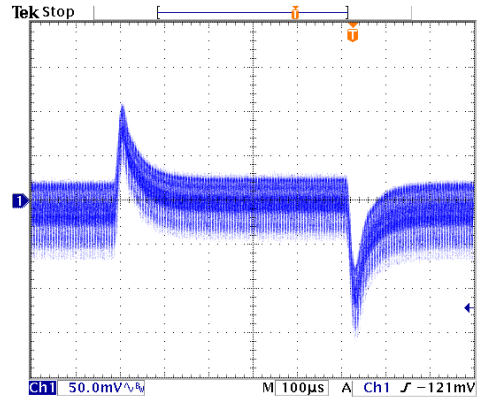

Transient Response to Dynamic Load Change from
100% to 75% to 100% of Full Load ; Vin = Vin(nom)

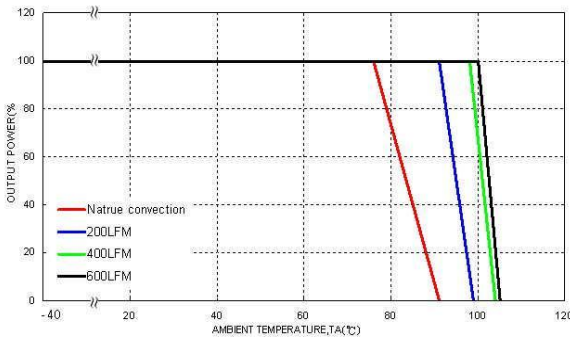

Derating Output Current versus Ambient Temperature and Airflow
Vin = Vin(nom)

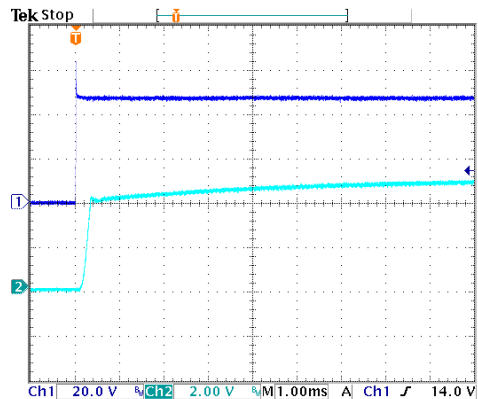

Typical Input Start-Up and Output Rise Characteristic
Vin = Vin(nom) ; Full Load

Characteristic Curves (Continued)

All test conditions are at 25 °C. PXA15-48WS05

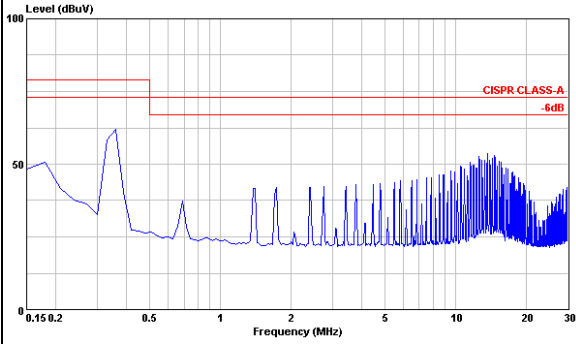

Conduction Emission of EN55022 Class A
 $V_{in} = V_{in(nom)}$; Full Load

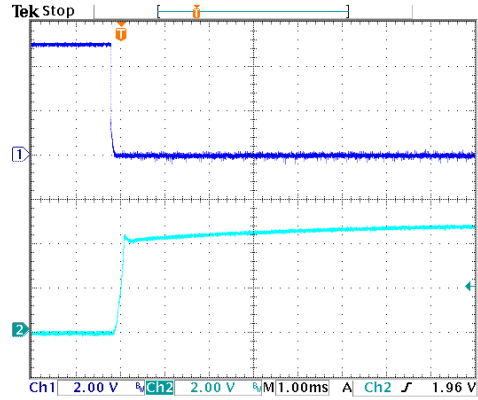

Using ON/OFF Voltage Start-Up and V_o Rise Characteristic
 $V_{in} = V_{in(nom)}$; Full Load

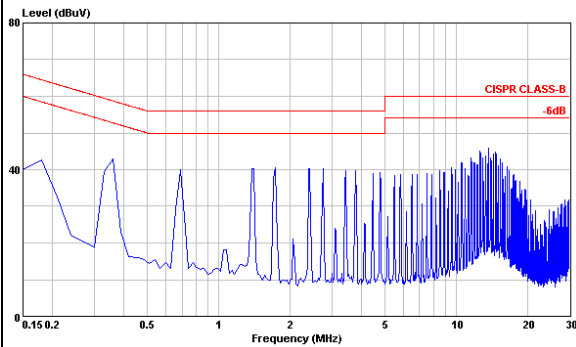

Conduction Emission of EN55022 Class B
 $V_{in} = V_{in(nom)}$; Full Load

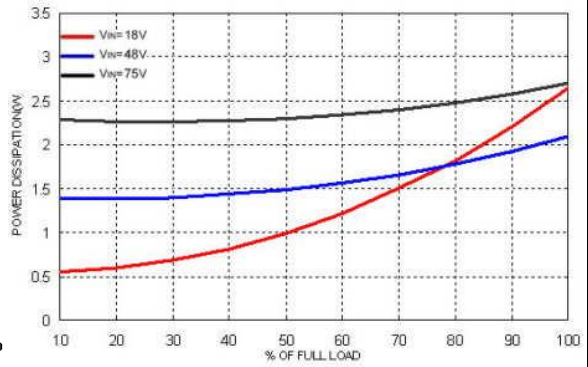

Power Dissipation versus Output Current

Characteristic Curves (Continued)

All test conditions are at 25 °C. PXA15-48WS12

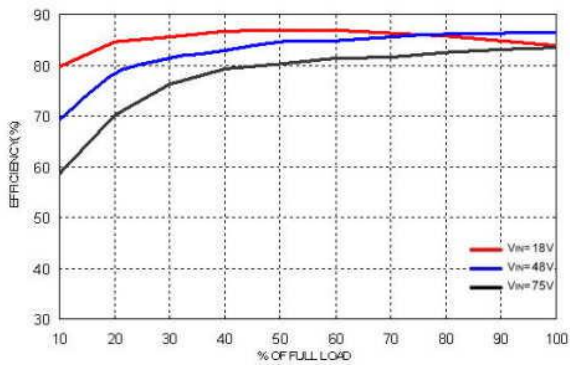

Efficiency versus Output Current

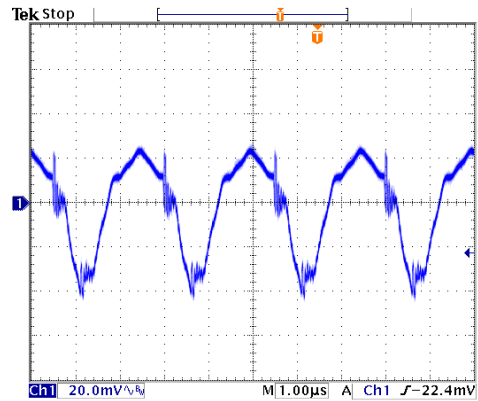

Typical Output Ripple and Noise.

Vin = Vin(nom) ; Full Load

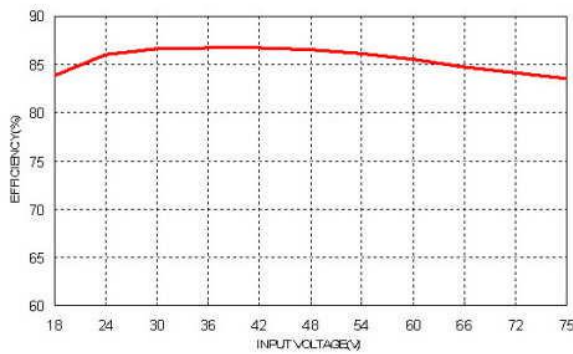

Efficiency versus Input Voltage, Full Load

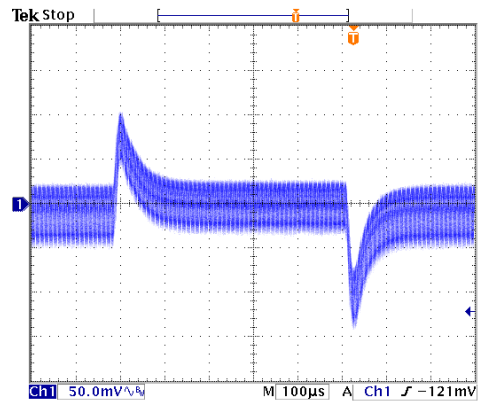

Transient Response to Dynamic Load Change from 100% to 75% to 100% of Full Load ; Vin = Vin(nom)

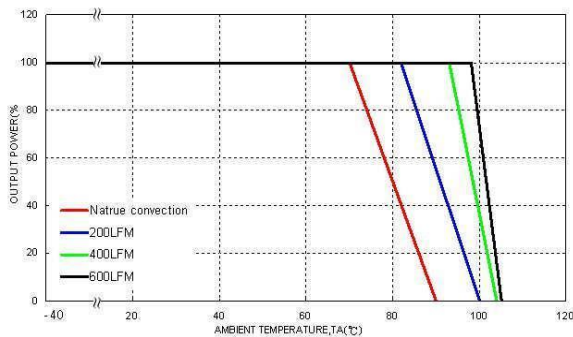

Derating Output Current versus Ambient Temperature and Airflow
Vin = Vin(nom)

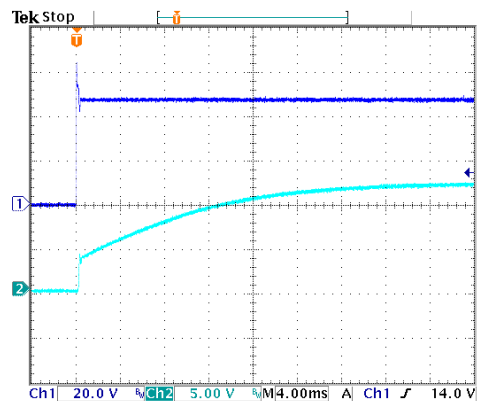

Typical Input Start-Up and Output Rise Characteristic
Vin = Vin(nom) ; Full Load

Characteristic Curves (Continued)

All test conditions are at 25 °C. PXA15-48WS12

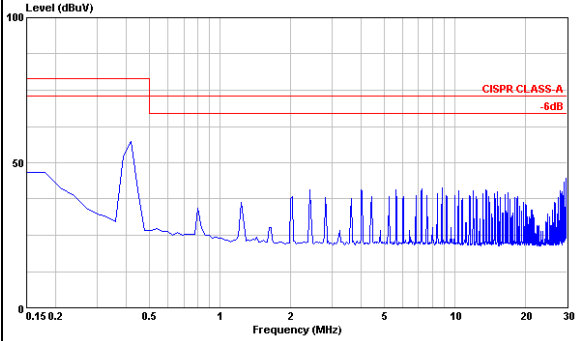

Conduction Emission of EN55022 Class A
 $V_{in} = V_{in(nom)}$; Full Load

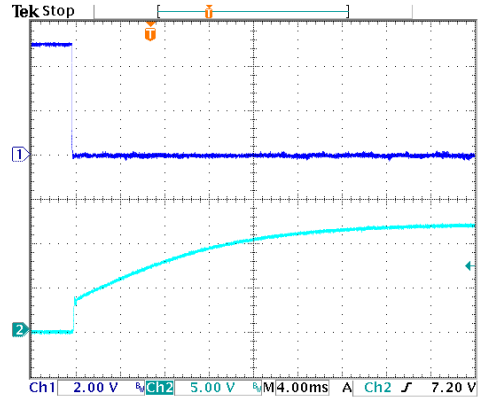

Using ON/OFF Voltage Start-Up and V_o Rise Characteristic
 $V_{in} = V_{in(nom)}$; Full Load

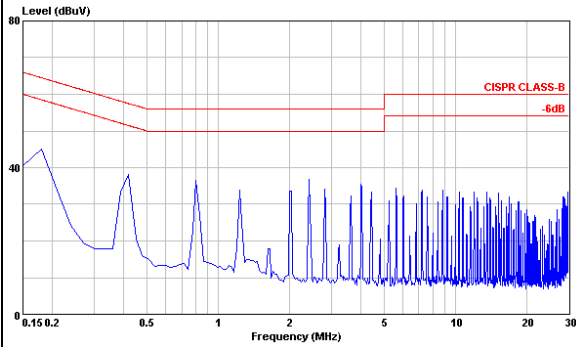

Conduction Emission of EN55022 Class B
 $V_{in} = V_{in(nom)}$; Full Load

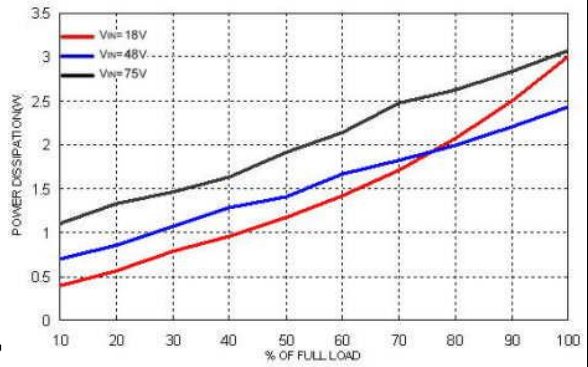

Power Dissipation versus Output Current

Characteristic Curves (Continued)

All test conditions are at 25 °C. PXA15-48WS15

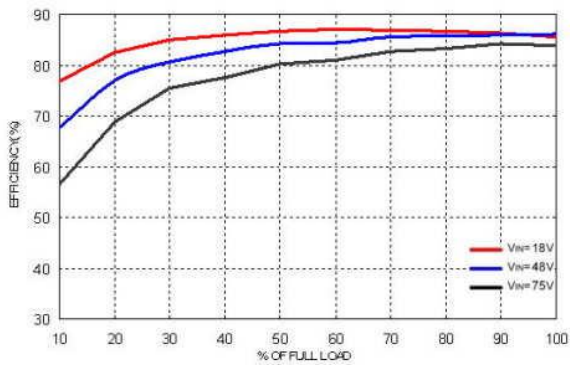

Efficiency versus Output Current

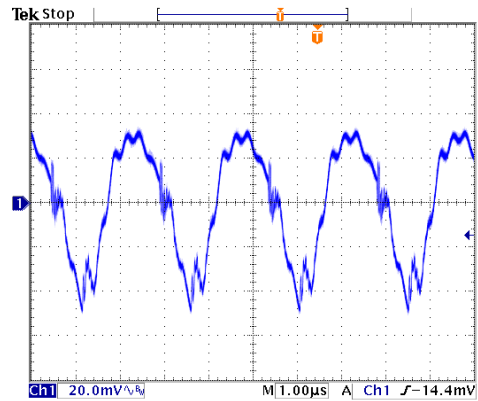

Typical Output Ripple and Noise.

Vin = Vin(nom) ; Full Load

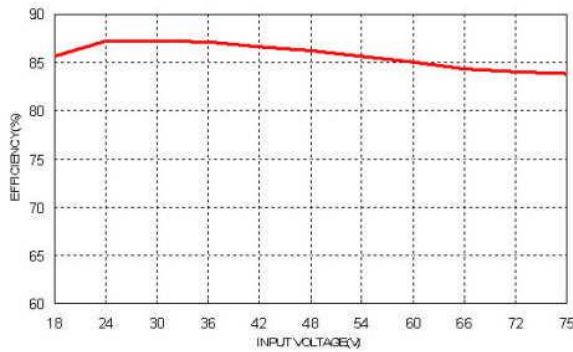

Efficiency versus Input Voltage, Full Load

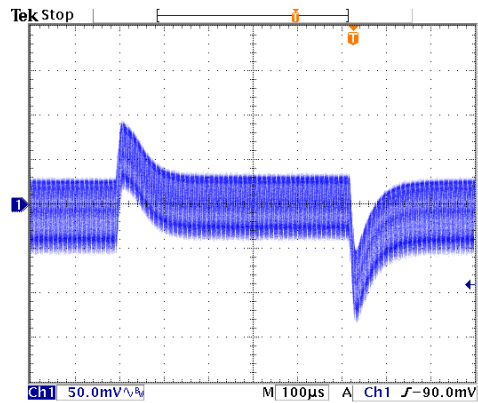

Transient Response to Dynamic Load Change from 100% to 75% to 100% of Full Load ; Vin = Vin(nom)

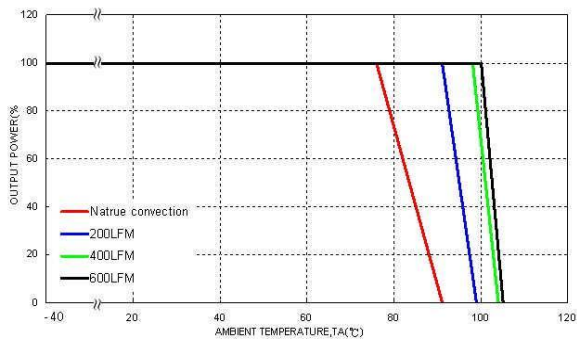

Derating Output Current versus Ambient Temperature and Airflow
Vin = Vin(nom)

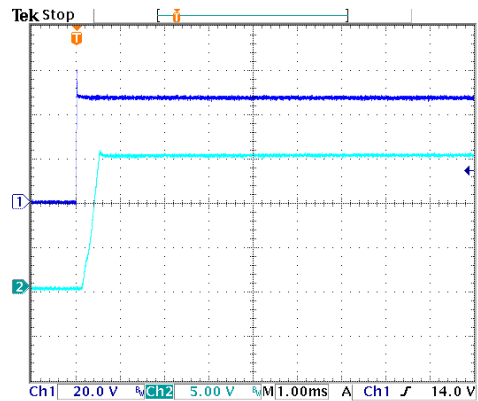

Typical Input Start-Up and Output Rise Characteristic
Vin = Vin(nom) ; Full Load

Characteristic Curves (Continued)

All test conditions are at 25 °C. PXA15-48WS15

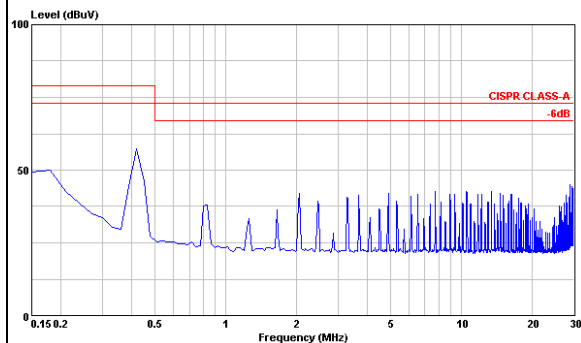

Conduction Emission of EN55022 Class A
 $V_{in} = V_{in(nom)}$; Full Load

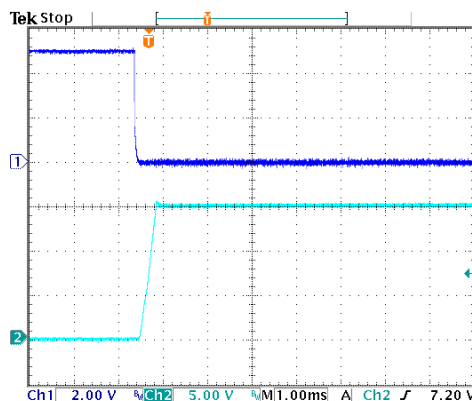

Using ON/OFF Voltage Start-Up and V_o Rise Characteristic
 $V_{in} = V_{in(nom)}$; Full Load

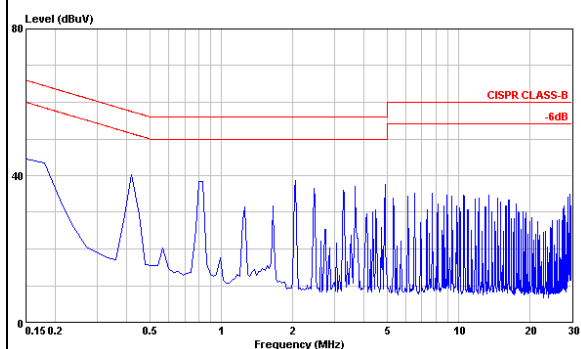

Conduction Emission of EN55022 Class B
 $V_{in} = V_{in(nom)}$; Full Load

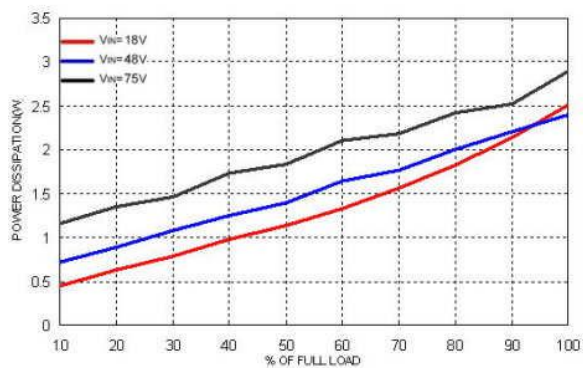

Power Dissipation versus Output Current

Testing Configurations

Input reflected-ripple current measurement

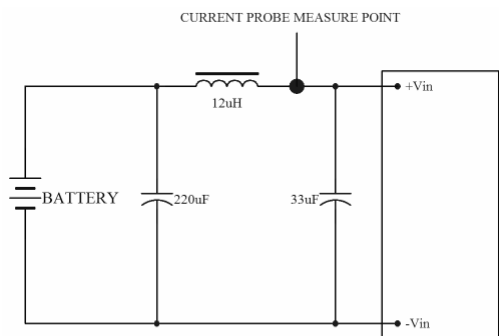

Component	Value	Voltage	Reference
L	12µH	---	---
C	220µF	100V	Aluminum Electrolytic Capacitor
C	33µF	100V	Aluminum Electrolytic Capacitor

Peak-to-peak output ripple & noise measurement

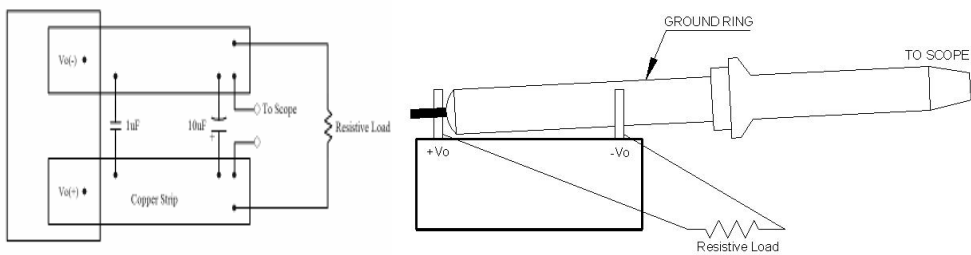

Output voltage and efficiency measurement

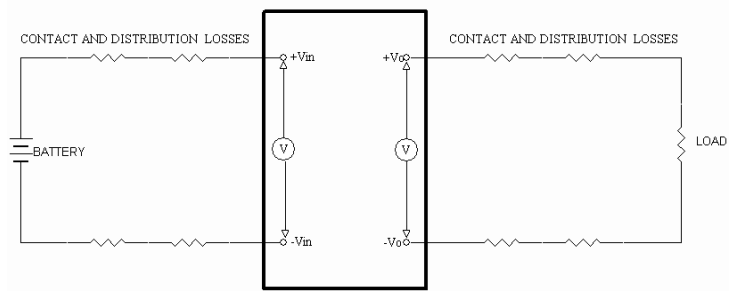

Note: All measurements are taken at the module terminals.

$$Efficiency = \left(\frac{V_o \times I_o}{V_{in} \times I_{in}} \right) \times 100\%$$

EMC considerations

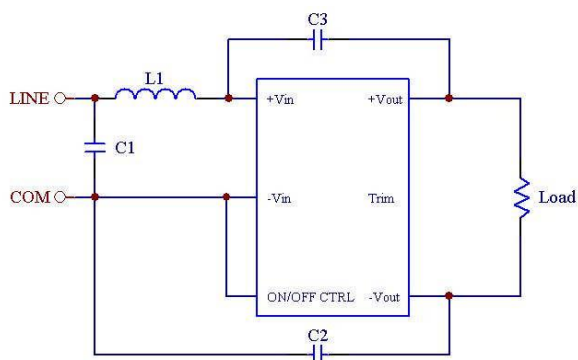

Suggested schematic for EN55022 conducted emission Class A limits

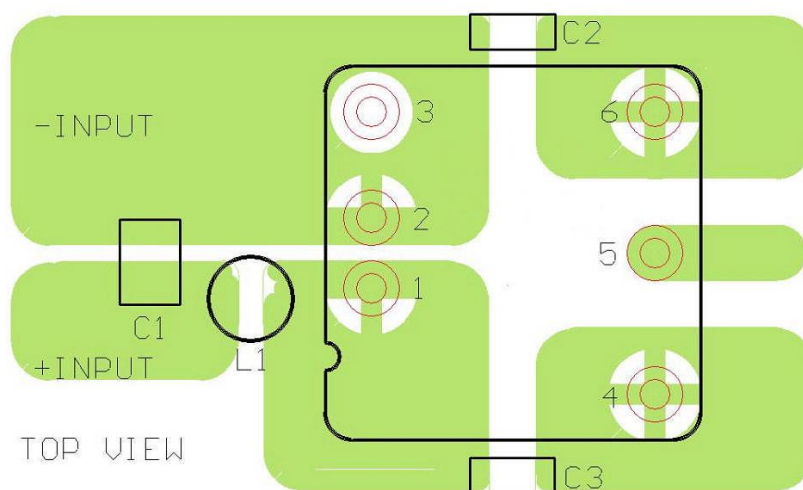

Recommended layout with input filter

To meet conducted emissions EN55022 CLASS A, the following components are needed:

PXA15-24WSXX

Component	Value	Voltage	Reference
L1	10 μ H	---	2.6A 0.04 Ω 0705 SMD Inductor
C1	6.8 μ F	50V	1812 MLCC
C2 & C3	470pF	3KV	1808 MLCC

PXA15-48WSXX

Component	Value	Voltage	Reference
L1	18 μ H	---	1.6A 0.1 Ω 0705 SMD Inductor
C1	2.2 μ F	100V	1812 MLCC
C2 & C3	470pF	3KV	1808 MLCC

EMC considerations (Continued)

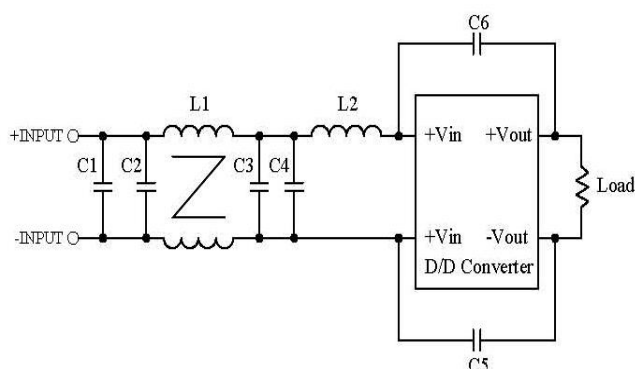

Suggested schematic for EN55022 conducted emission Class B limits

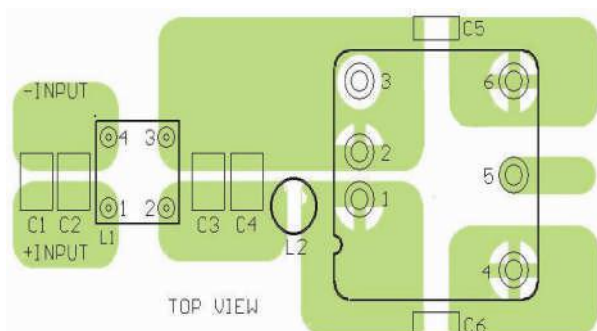

Recommended layout with input filter

To meet conducted emissions EN55022 CLASS B, the following components are needed:

PXA15-24WSXX

Component	Value	Voltage	Reference
C1	----	----	----
C2, C3 & C4	6.8 μ F	50V	1812 MLCC
C5 & C6	470pF	3KV	1808 MLCC
L1	145 μ H	----	Common Choke
L2	10 μ H	----	2.6A 0.04 Ω 0705 SMD Inductor

PXA15-48WSXX

Component	Value	Voltage	Reference
C1	2.2 μ F	100V	1812 MLCC
C2, C3 & C4	2.2 μ F	100V	1812 MLCC
C5 & C6	470pF	3KV	1808 MLCC
L1	325 μ H	----	Common Choke
L2	33 μ H	----	1.2A 0.13 Ω 0705 SMD Inductor

Input Source Impedance

The power module should be connected to a low impedance input source. Highly inductive source impedance can affect the stability of the power module. Input external C-L-C filter is recommended to minimize input reflected ripple current. The inductor is simulated source impedance of 12 μ H and the capacitor is Nippon chemi-con KZE series 220 μ F/100V&33 μ F/100V. The capacitor must be located as close as possible to the input terminals of the power module for lower impedance.

Output Over Current Protection

When excessive output currents occur in the system, circuit protection is required on all power supplies. Normally, overload current is maintained at approximately 150 percent of rated current for PXA15WS single output series.

Hiccup-mode is a method of operation in a power supply whose purpose is to protect the power supply from being damaged during an over-current fault condition. It also enables the power supply to restart when the fault is removed.

One of the problems resulting from over current is that excessive heat may be generated in power devices; especially MOSFET and Schottky diodes and the temperature of those devices may exceed their specified limits. A protection mechanism has to be used to prevent those power devices from being damaged.

Output Over Voltage Protection

The output over-voltage protection consists of a Zener diode that monitors the output voltage on the feedback loop. If the voltage on the output terminals exceeds the over-voltage protection threshold, then the Zener diode will send a signal to the control IC to limit the output voltage.

Output Voltage Adjustment

Output voltage set point adjustment allows the user to increase or decrease the output voltage set point of a module. This is accomplished by connecting an external resistor between the TRIM pin and either the Vo (+) or Vo (-) pins. With an external resistor between the TRIM and Vo (-) pin, the output voltage set point increases. With an external resistor between the TRIM and Vo (+) pin, the output voltage set point decreases.

- Trim up equation

$$R_U = \left[\frac{G \times L}{(V_{O,up} - L - K)} - H \right] \Omega$$

- Trim down equation

$$R_D = \left[\frac{(V_{O,down} - L) \times G}{(V_O - V_{O,down})} - H \right] \Omega$$

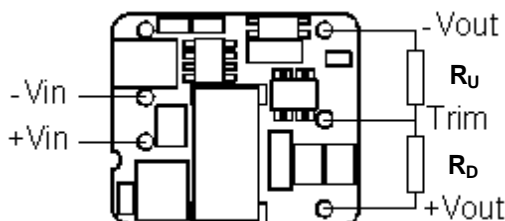

- Trim constants

Module	G	H	K	L
PXA15-XXWS3P3	5110	2050	0.8	2.5
PXA15-XXWS05	5110	2050	2.5	2.5
PXA15-XXWS12	10000	5110	9.5	2.5
PXA15-XXWS15	10000	5110	12.5	2.5

TRIM TABLE

PXA15-XXWS3P3

Trim up (%)	1	2	3	4	5	6	7	8	9	10
V _{OUT} (Volts)=	3.333	3.366	3.399	3.432	3.465	3.498	3.531	3.564	3.597	3.630
R _U (K Ohms)=	385.071	191.511	126.990	94.730	75.374	62.470	53.253	46.340	40.963	36.662
Trim down (%)	1	2	3	4	5	6	7	8	9	10
V _{OUT} (Volts)=	3.267	3.234	3.201	3.168	3.135	3.102	3.069	3.036	3.003	2.970
R _D (K Ohms)=	116.719	54.779	34.133	23.810	17.616	13.486	10.537	8.325	6.604	5.228

PXA15-XXWS05

Trim up (%)	1	2	3	4	5	6	7	8	9	10
V _{OUT} (Volts)=	5.050	5.100	5.150	5.200	5.250	5.300	5.350	5.400	5.450	5.500
R _U (K Ohms)=	253.450	125.700	83.117	61.825	49.050	40.533	34.450	29.888	26.339	23.500
Trim down (%)	1	2	3	4	5	6	7	8	9	10
V _{OUT} (Volts)=	4.950	4.900	4.850	4.800	4.750	4.700	4.650	4.600	4.550	4.500
R _D (K Ohms)=	248.340	120.590	78.007	56.715	43.940	35.423	29.340	24.778	21.229	18.390

PXA15-XXWS12

Trim up (%)	1	2	3	4	5	6	7	8	9	10
V _{OUT} (Volts)=	12.120	12.240	12.360	12.480	12.600	12.720	12.840	12.960	13.080	13.200
R _U (K Ohms)=	203.223	99.057	64.334	46.973	36.557	29.612	24.652	20.932	18.038	15.723
Trim down (%)	1	2	3	4	5	6	7	8	9	10
V _{OUT} (Volts)=	11.880	11.760	11.640	11.520	11.400	11.280	11.160	11.040	10.920	10.800
R _D (K Ohms)=	776.557	380.723	248.779	182.807	143.223	116.834	97.985	83.848	72.853	64.057

PXA15-XXWS15

Trim up (%)	1	2	3	4	5	6	7	8	9	10
V _{OUT} (Volts)=	15.150	15.300	15.450	15.600	15.750	15.900	16.050	16.200	16.350	16.500
R _U (K Ohms)=	161.557	78.223	50.446	36.557	28.223	22.668	18.700	15.723	13.409	11.557
Trim down (%)	1	2	3	4	5	6	7	8	9	10
V _{OUT} (Volts)=	14.850	14.700	14.550	14.400	14.250	14.100	13.950	13.800	13.650	13.500
R _D (K Ohms)=	818.223	401.557	262.668	193.223	151.557	123.779	103.938	89.057	77.483	68.223

Short Circuit Protection

Continuous, hiccup and auto-recovery mode.

During a short circuit condition the converter will shut down. The average current during this condition will be very low and damage to this device should not occur.

Thermal Consideration

The power module operates in a variety of thermal environments. However, sufficient cooling should be provided to help ensure reliable operation of the unit. Heat is removed by conduction, convection, and radiation to the surrounding environment. Proper cooling can be verified by measuring the point as shown in the figure below. The temperature at this location should not exceed 120 °C. When Operating, adequate cooling must be provided to maintain the test point temperature at or below 120 °C. Although the maximum point temperature of the power module is 120 °C, maintaining a lower operating temperature will increase the reliability of this device.

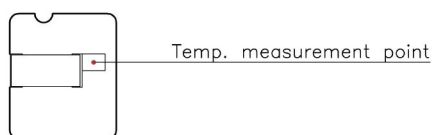

TOP VIEW

Remote ON/OFF Control

The Remote ON/OFF Pin is used to turn the DC/DC power module on and off. The user must connect a switch between the on/off pin and the Vi (-) pin. The switch can be open collector transistor, FET, or Photo-Coupler. The switch must be capable of sinking up to 1 mA at low logic level voltage. When using a high logic level, the maximum signal voltage is 15V and the maximum allowable leakage current of the switch is 50 μ A.

Remote ON/OFF Implementation Circuits

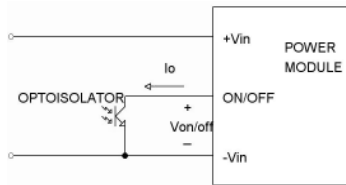

Isolated-Closure Remote ON/OFF

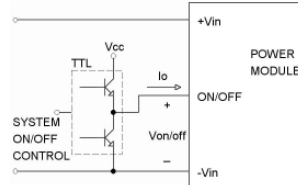

Level Control Using TTL Output

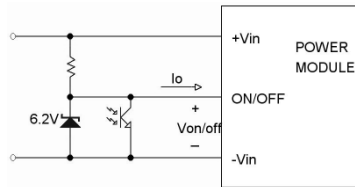

Level Control Using Line Voltage

There are two remote control options available, positive logic and negative logic.

a. Positive logic - The DC/DC module is turned on when the ON/OFF pin is at a high logic level. A low logic signal is needed to turn off the device.

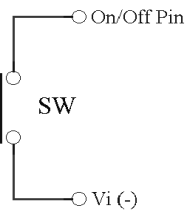

When PXA15WS module is turned off
at Low logic level

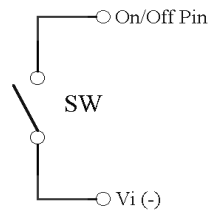

When PXA15WS module is turned on
at High logic level

b. Negative logic - The DC/DC module is turned on when the ON/OFF pin is at low logic level. A high logic level signal is needed to turn off the device.

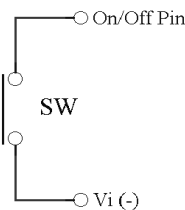

When PXA15WS module is turned on
at Low logic level

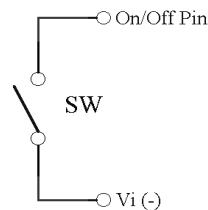

When PXA15WS module is turned off
at High logic level

Mechanical Data

DIP TYPE

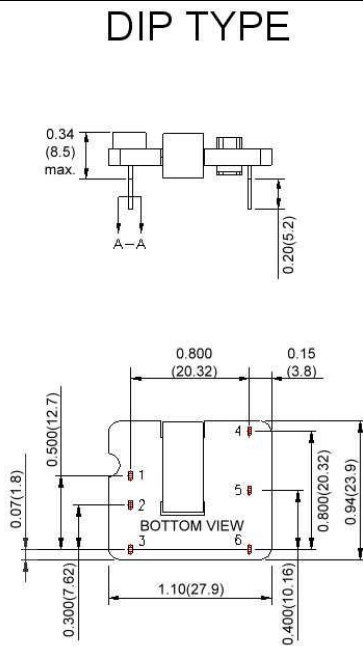

SMD TYPE

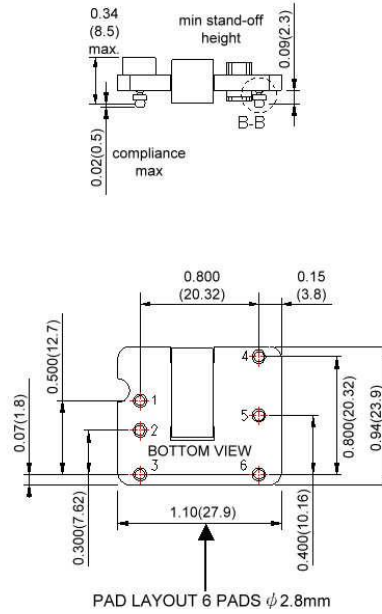

1. All dimensions in inches(mm)
2. Tolerance : $x.xx \pm 0.02(x.xx \pm 0.5)$
 $x.xxx \pm 0.010(x.xx \pm 0.25)$
3. Pin pitch tolerance $\pm 0.014(0.35)$

PIN CONNECTION

PIN	PXA15WS SERIES
1	+ INPUT
2	- INPUT
3	ON/OFF
4	+VOUT
5	TRIM
6	-VOUT

EXTERNAL OUTPUT TRIMMING

Output can be externally trimmed by using the method shown below.

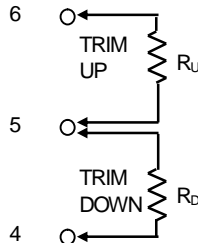

OPTIONS

Suffix	Description
P	Positive Logic
N	Negative Logic
S	Surface Mount
T	Trim

-NST or NT as standard
Delete suffix if not required

Recommended Pad Layout

Recommended pad layout for DIP type

ALL Dimensions in millimeters (inches)
Tolerances: xx.xx mm ± 0.25 mm (xx.xxx in ± 0.010 in)

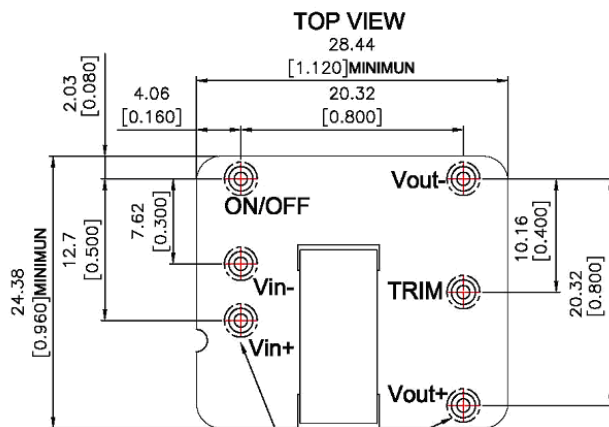

PAD SIZE
THROUGH HOLE: ϕ 1.2mm
TOP VIEW PAD: ϕ 2.0mm (LEFD FREE RECOMMENDED)
BOTTOM VIEW PAD: ϕ 3.0mm

Recommended pad layout for SMD type

ALL Dimensions in millimeters (inches)
Tolerances: xx.xx mm ± 0.25 mm (xx.xxx in ± 0.010 in)

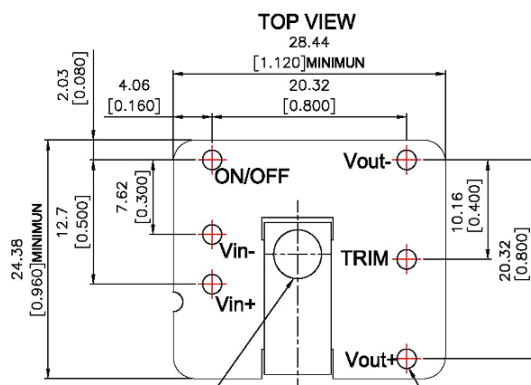

RECOMMENDED PICK AND PLACE

6-PAD SIZE
MINIMUM: ϕ 1.9mm
RECOMMENDED: ϕ 2.8mm

Soldering and Reflow Considerations

Lead free wave solder profile for DIP type

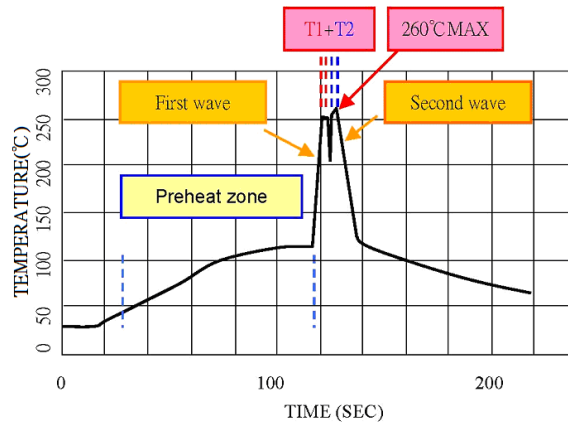

Zone	Reference Parameter.
Preheat zone	Rise temp. speed: 3 °C/sec max. Preheat temp.100~130 °C
Actual heating	Peak temp. :250~260 °C Peak time(T1+T2 time):4~6 sec

Lead free reflow profile for SMD type

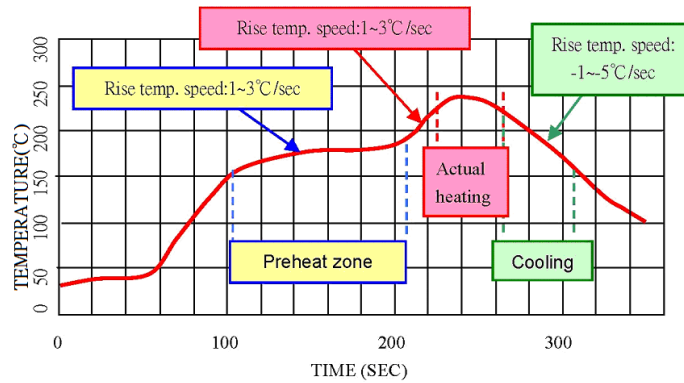

Zone	Reference Parameter.
Preheat zone	Rise temp. speed:1~3 °C/sec Preheat time:60~90sec Preheat temp.155~185 °C
Actual heating	Rise temp. speed:1~3 °C/sec Melting time:20~40 sec Melting temp:220 °C Peak temp. :230~240 °C Peak time:10~20 sec
Cooling	Rise temp. speed: -1~5 °C/sec

Cleaning and Drying Considerations

Cleaning process

a. PWB cooling prior to cleaning:

Power modules and their associated application PWB assemblies should not be cleaned after soldering until the power modules have had an opportunity to cool to within the cleaning solution temperature. This will prevent vacuum absorption of the cleaning liquid into the module between the pins and the potting during cooling.

b. Cleaning process:

In aqueous cleaning, it is preferred to have an in-line system consisting of several cleaning stages (prewash, wash, rinse, final rinse, and drying). De-ionized (DI) water is recommended for aqueous cleaning; the minimum resistivity level is 1M Ω -cm. Tap-water quality varies per region in terms of hardness, chloride, and solid contents; therefore, the use of tap water is not recommended for aqueous cleaning. The total time of ultrasonic wave shall be less than 3 minutes.

Drying

After cleaning, dry converters at 100 °C, more than 10minutes to assure that the moisture and other potential foreign contaminants are driven out. For open power module construction having transformers and inductors that have unspotted windings, a baking process of 100 °C for 30 min. is recommended for the assembly to ensure that the moisture and other potential foreign contaminants are driven out from the open windings.

The drying section of the cleaning system should be equipped with blowers capable of generating 1000 cfm-1500 cfm of air so that the amount of rinse water left to be dried off with heat is minimal. Handheld air guns are not recommended due to the variability and inconsistency of the operation.

Product Post-wash external appearance

The marking or date-code may fade or disappear after cleaning.

Part Number Structure

PXA 15 - 24W S 05 -A

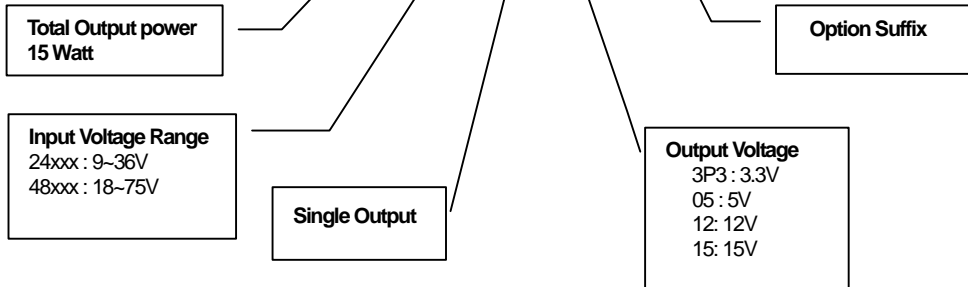

Model Number	Input Range	Output Voltage	Output Current	Input Current	Eff ⁽²⁾ (%)
			Full Load	Full Load ⁽¹⁾	
PXA15-24WS3P3	9 - 36 VDC	3.3 VDC	4000mA	680mA	85
PXA15-24WS05	9 - 36 VDC	5 VDC	3000mA	754mA	87
PXA15-24WS12	9 - 36 VDC	12 VDC	1300mA	793mA	86
PXA15-24WS15	9 - 36 VDC	15 VDC	1000mA	763mA	86
PXA15-48WS3P3	18 - 75 VDC	3.3 VDC	4000mA	340mA	85
PXA15-48WS05	18 - 75 VDC	5 VDC	3000mA	377mA	87
PXA15-48WS12	18 - 75 VDC	12 VDC	1300mA	397mA	86
PXA15-48WS15	18 - 75 VDC	15 VDC	1000mA	382mA	86

Note 1. Maximum value at nominal input voltage and full load.
Note 2. Typical value at nominal input voltage and full load.

Safety and Installation Instruction

Fusing Consideration

Caution: This power module is not internally fused. An input line fuse must always be used.

This encapsulated power module can be used in a wide variety of applications, ranging from simple stand-alone operation to an integrated part of sophisticated power architecture. For maximum flexibility, internal fusing is not included; however, to achieve maximum safety and system protection, always use an input line fuse. The safety agencies require a normal-blow fuse with maximum rating of 3A for PXA15-24WSXX modules and 1.5A for PXA15-48WSXX modules. Based on the information provided in this data sheet on Inrush energy and maximum DC input current; the same type of fuse with lower rating can be used. Refer to the fuse manufacturer's data for further information.

MTBF and Reliability

The MTBF of PXA15WS SERIES of DC/DC converters has been calculated using:

Bellcore TR-NWT-000332 Case I: 50% stress, Operating Temperature at 40 °C (Ground fixed and controlled environment). The resulting figure for MTBF is 1.322x10⁶ hours.

MIL-HDBK 217F NOTICE2 FULL LOAD, Operating Temperature at 25.. The resulting figure for MTBF is 5.147x10⁵ hours.