

SERIES: PDME2-S | **DESCRIPTION:** DC-DC CONVERTER

FEATURES

- 2 W isolated output
- single/dual unregulated output
- 1500 Vdc isolation
- continuous short circuit protection
- extended temperature range (-40~105°C)
- no-load input current as low as 8mA
- efficiency up to 86%
- UL 62368-1 certified
- designed to meet EN/BS EN 62368

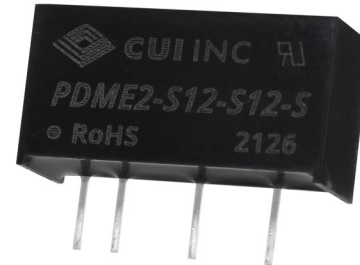

MODEL	input voltage		output voltage (Vdc)	output current		output power max (W)	ripple & noise ¹ max (mVp-p)	efficiency ² typ (%)
	typ (Vdc)	range (Vdc)		min (mA)	max (mA)			
PDME2-S5-D3-S ⁴	5	4.5~5.5	±3.3	±30	±303	2	200	75
PDME2-S5-D5-S ⁴	5	4.5~5.5	±5	±20	±200	2	200	84
PDME2-S5-D9-S ⁴	5	4.5~5.5	±9	±11	±111	2	200	85
PDME2-S5-D12-S ⁴	5	4.5~5.5	±12	±8	±83	2	200	85
PDME2-S5-D15-S ⁴	5	4.5~5.5	±15	±7	±67	2	200	86
PDME2-S5-D24-S ⁴	5	4.5~5.5	±24	±4	±42	2	200	86
PDME2-S5-S3-S ⁴	5	4.5~5.5	3.3	40	400	1.32	200	78
PDME2-S5-S5-S ⁴	5	4.5~5.5	5	40	400	2	200	84
PDME2-S5-S7-S ⁴	5	4.5~5.5	7.2	28	278	2	200	84
PDME2-S5-S9-S ⁴	5	4.5~5.5	9	22	222	2	200	85
PDME2-S5-S12-S ⁴	5	4.5~5.5	12	17	167	2	200	85
PDME2-S5-S15-S ⁴	5	4.5~5.5	15	13	133	2	200	86
PDME2-S5-S24-S ⁴	5	4.5~5.5	24	8	83	2	200	86
PDME2-S12-D3-S	12	10.8~13.2	±3.3	±30	±303	2	180	75
PDME2-S12-D5-S	12	10.8~13.2	±5	±20	±200	2	180	80
PDME2-S12-D9-S ⁴	12	10.8~13.2	±9	±11	±111	2	180	82
PDME2-S12-D12-S	12	10.8~13.2	±12	±8	±83	2	180	83
PDME2-S12-D15-S	12	10.8~13.2	±15	±7	±67	2	180	83
PDME2-S12-D24-S ⁴	12	10.8~13.2	±24	±4	±42	2	180	83
PDME2-S12-S5-S	12	10.8~13.2	5	40	400	2	180	82
PDME2-S12-S9-S ⁴	12	10.8~13.2	9	22	222	2	180	82
PDME2-S12-S12-S	12	10.8~13.2	12	17	167	2	180	84
PDME2-S12-S15-S	12	10.8~13.2	15	13	133	2	180	85
PDME2-S12-S24-S	12	10.8~13.2	24	8	83	2	180	86
PDME2-S15-D5-S ⁴	15	13.5~16.5	±5	±20	±200	2	180	80
PDME2-S15-D15-S ⁴	15	13.5~16.5	±15	±7	±67	2	180	82
PDME2-S15-S5-S ⁴	15	13.5~16.5	5	40	400	2	180	80

MODEL (CONTINUED)

	input voltage		output voltage (Vdc)	output current		output power max (W)	ripple & noise ¹ max (mVp-p)	efficiency ² typ (%)
	typ (Vdc)	range (Vdc)		min (mA)	max (mA)			
PDME2-S15-S15-S ⁴	15	13.5~16.5	15	13	133	2	180	81
PDME2-S15-S24-S ⁴	15	13.5~16.5	24	8	83	2	180	81
PDME2-S24-D3-S ⁴	24	21.6~26.4	±3.3	±30	±300	2	180	76
PDME2-S24-D5-S	24	21.6~26.4	±5	±20	±200	2	180	80
PDME2-S24-D9-S ⁴	24	21.6~26.4	±9	±11	±111	2	180	81
PDME2-S24-D12-S	24	21.6~26.4	±12	±8	±83	2	180	83
PDME2-S24-D15-S	24	21.6~26.4	±15	±7	±67	2	180	83
PDME2-S24-D24-S ⁴	24	21.6~26.4	±24	±4	±42	2	180	83
PDME2-S24-S3-S ⁴	24	21.6~26.4	3.3	40	400	1.32	180	76
PDME2-S24-S5-S	24	21.6~26.4	5	40	400	2	180	80
PDME2-S24-S9-S ⁴	24	21.6~26.4	9	22	222	2	180	81
PDME2-S24-S12-S	24	21.6~26.4	12	17	167	2	180	84
PDME2-S24-S15-S	24	21.6~26.4	15	13	133	2	180	86
PDME2-S24-S24-S	24	21.6~26.4	24	8	83	2	180	86

- Notes:
1. Measured at nominal input, 20 MHz bandwidth oscilloscope, with 10 µF tantalum and 1 µF ceramic capacitors on the output.
 2. Measured at nominal input voltage, full load.
 3. All specifications are measured at T_a=25°C, humidity < 75%, nominal input voltage, and rated output load unless otherwise specified.
 4. Model is not UL certified.

PART NUMBER KEY

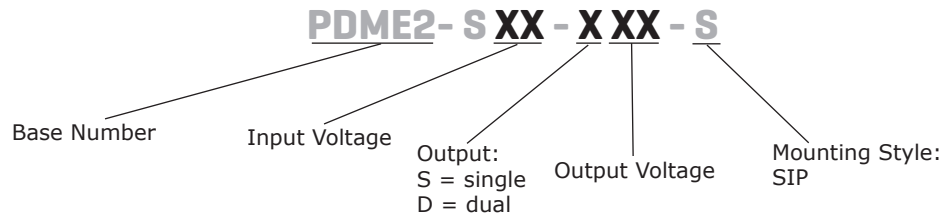

INPUT

parameter	conditions/description	min	typ	max	units
operating input voltage	5 Vdc input models	4.5	5	5.5	Vdc
	12 Vdc input models	10.8	12	13.2	Vdc
	15 Vdc input models	13.5	15	16.5	Vdc
	24 Vdc input models	21.6	24	26.4	Vdc
surge voltage	for maximum of 1 second				
	5 Vdc input models	-0.7		9	Vdc
	12 Vdc input models	-0.7		18	Vdc
	15 Vdc input models	-0.7		21	Vdc
current	5 Vdc input models				
		3.3 Vdc output		564	mA
		5 & 7.2 Vdc output		500	mA
		9 & 12 Vdc output		494	mA
	15 & 24 Vdc output		488	mA	
	12 Vdc input models			208	mA
	15 Vdc input models			167	mA
	24 Vdc input models			104	mA
filter	filter capacitor				

OUTPUT

parameter	conditions/description	min	typ	max	units
maximum capacitive load ⁵	3.3, 5 Vdc output models			2,400	μF
	±3.3, ±5 Vdc output models			1,200	μF
	9 Vdc output models			1,000	μF
	12, 15 Vdc output models			560	μF
	24, ±12, ±15 Vdc output models			220	μF
	±9 Vdc output models			470	μF
	±24 Vdc output models			100	μF
voltage accuracy	see output regulation curves				
line regulation	for Vin change of 1%				
	3.3 Vdc output models			±1.5	%
	all other output models			±1.2	%
load regulation	from 10% to full load				
	3.3 Vdc output models		10		%
	5 Vdc output models		8		%
	9, 12 & 15 Vdc output models		7		%
	24 Vdc output models		5		%
switching frequency	from 10% to full load				
	3.3 Vdc output models		15		%
	5 Vdc output models		7		%
	9, 12 Vdc output models		5		%
	15 Vdc output models		4		%
temperature coefficient	100% load, nominal input voltage				
	5 Vdc input models		220		kHz
	all other input models		260		kHz
temperature coefficient	at full load		±0.02		%/°C

Note: 5. Tested at input voltage range and full load.

PROTECTIONS

parameter	conditions/description	min	typ	max	units
short circuit protection	continuous, auto recovery				

SAFETY AND COMPLIANCE

parameter	conditions/description	min	typ	max	units
isolation voltage	input to output for 1 minute at 1 mA	1,500			Vdc
isolation resistance	input to output at 500 Vdc	1,000			MΩ
isolation capacitance	input to output, 100 kHz / 0.1 V		20		pF
safety approvals	certified to 62368: UL designed to meet 62368: EN/BS EN				
conducted emissions	CISPR 32/EN 55032 Class B				
radiated emissions	CISPR 32/EN 55032 Class B				
ESD	IEC/EN 61000-4-2 Air ±8kV, Contact ±6kV				
MTBF	as per MIL-HDBK-217F, 25°C	3,500,000			hours
RoHS	yes				

ENVIRONMENTAL

parameter	conditions/description	min	typ	max	units
operating temperature	see derating curves	-40		105	°C
storage temperature		-55		125	°C
storage humidity	non-condensing	5		95	%
case temperature rise	at 25°C		15		°C

DERATING CURVES

TEMPERATURE DERATING CURVE

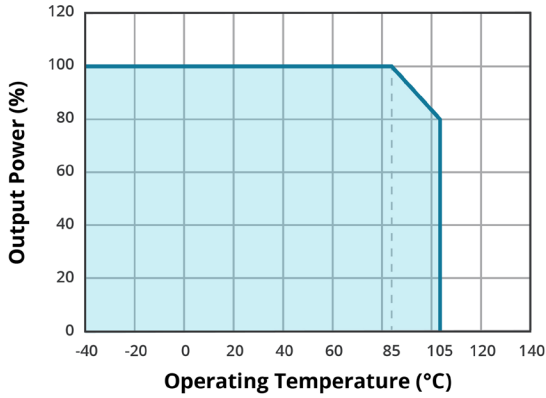

**OUTPUT REGULATION CURVE
5 Vdc input / 3.3 Vdc output
(nominal input)**

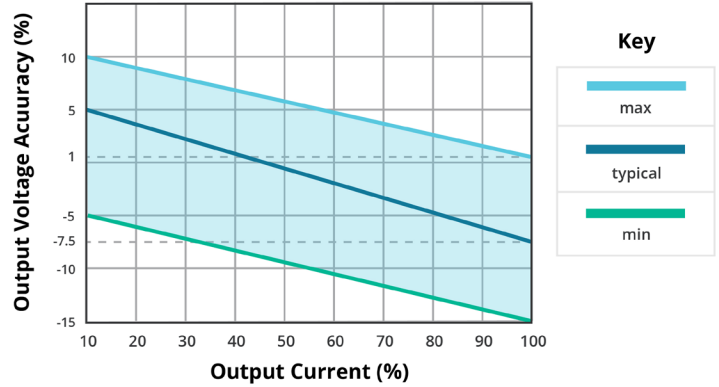

**OUTPUT REGULATION CURVE
5 Vdc input / all other output models
(nominal input)**

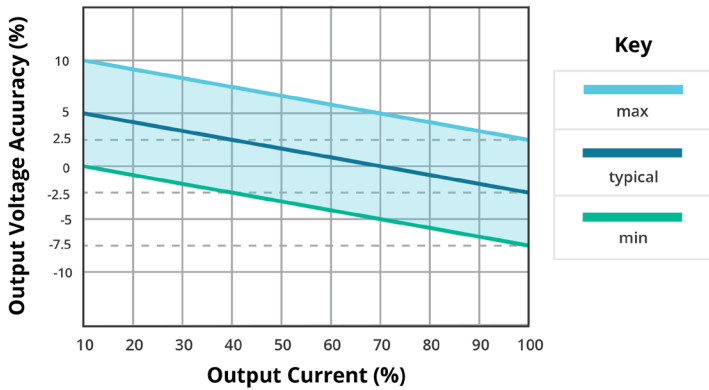

**OUTPUT REGULATION CURVE
all other input models / 3.3 Vdc output models
(nominal input)**

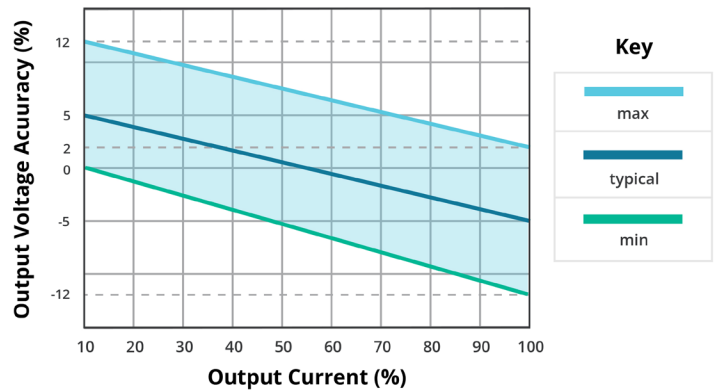

**OUTPUT REGULATION CURVE
all other input models / 5 Vdc output models
(nominal input)**

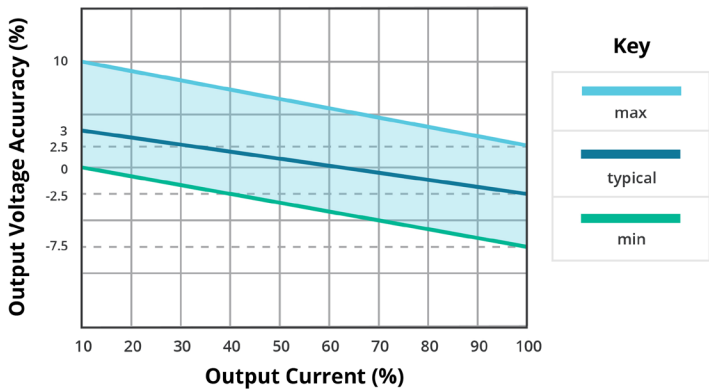

**OUTPUT REGULATION CURVE
all other input models / all other output models
(nominal input)**

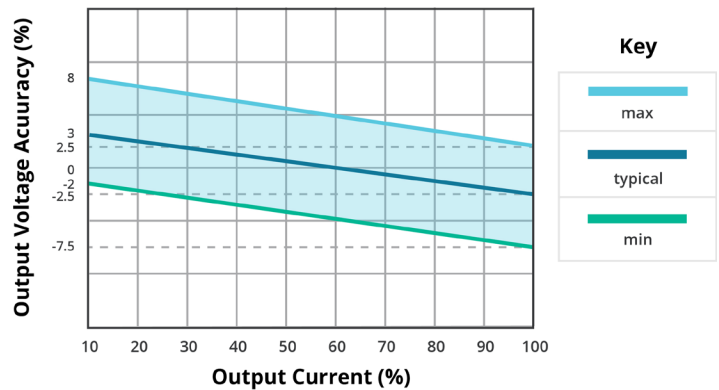

MECHANICAL

parameter	conditions/description	min	typ	max	units
dimensions	19.65 x 7.05 x 10.16 [0.773 x 0.277 x 0.400 inch]				mm
case material	black flame-retardant and heat-resistant plastic (UL94V-0)				
weight			2.4		g

MECHANICAL DRAWING

units: mm [inch]
 tolerance: $\pm 0.25[\pm 0.010]$
 pin section tolerance: $\pm 0.10[\pm 0.004]$

PIN CONNECTIONS		
PIN	Function / Single output	Function / Dual output
1	Vin	Vin
2	GND	GND
4	0V	-Vo
5	No pin	0V
6	+Vo	+Vo

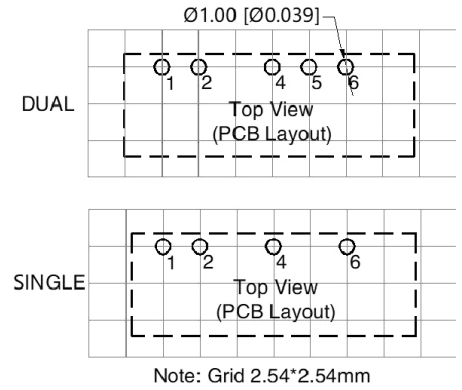
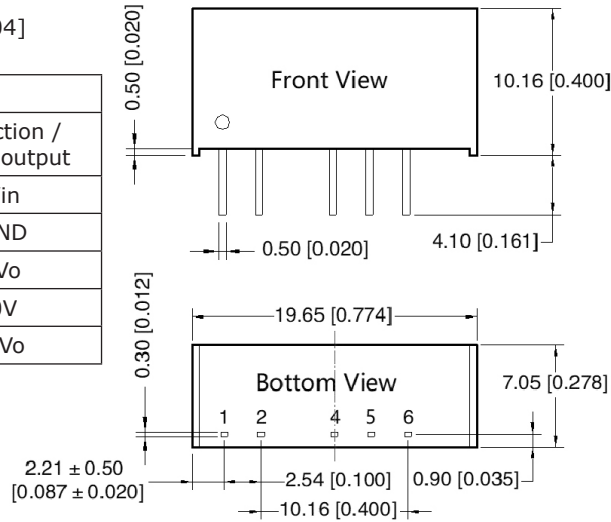

APPLICATION CIRCUIT

If you want to further reduce the input and output ripple, a filter capacitor may be connected to the input and output terminals (Figures 1 & 2) provided that the capacitance is less than the maximum capacitive load of the model, otherwise start-up problems may be caused if the capacitance is too large.

Figure 1
Single Output Models

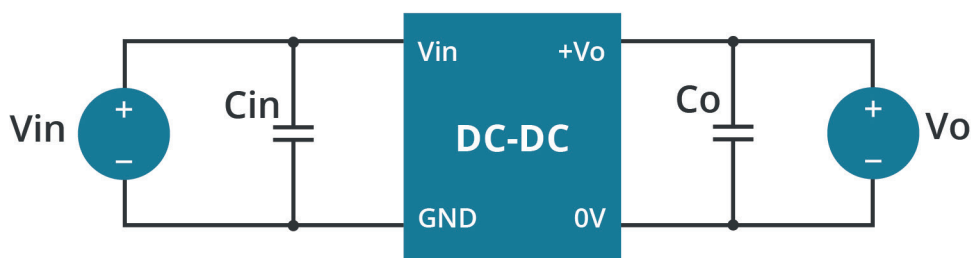

Table 1

Vin (Vdc)	Cin (μF / V)	Vo (Vdc)	Co (μF / V)
5	10 / 16	3.3	10 / 16
--	--	5	10 / 16
--	--	7.2	10 / 16
--	--	9	2.2 / 25
--	--	12	2.2 / 25
--	--	15	1 / 25
--	--	24	1 / 50
12	2.2 / 25	3.3	10 / 16
15	2.2 / 25	5	10 / 16
24	1 / 50	9	2.2 / 25
--	--	12	2.2 / 25
--	--	15	1 / 25
--	--	24	1 / 50

Figure 2
Dual Output Models

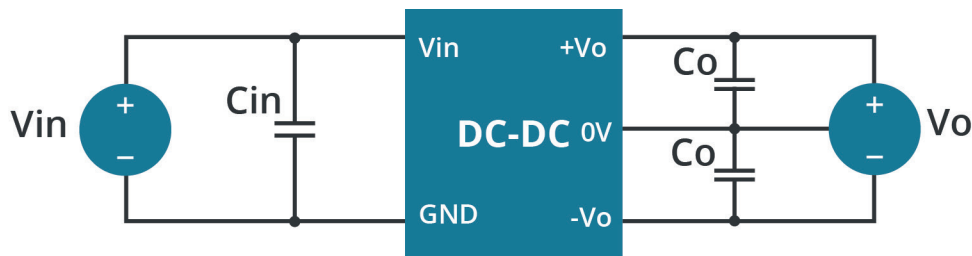

Table 2

Vin (Vdc)	Cin (μF / V)	Vo (Vdc)	Co ⁶ (μF / V)
5	10 / 16	±3.3	4.7 / 16
--	--	±5	4.7 / 16
--	--	±9	1 / 25
--	--	±12	1 / 25
--	--	±15	0.47 / 25
--	--	±24	0.47 / 50
12	2.2 / 25	±3.3	4.7 / 16
15	2.2 / 25	±5	4.7 / 16
24	1 / 50	±9	2.2 / 25
--	--	±12	1 / 25
--	--	±15	1 / 25
--	--	±24	0.47 / 50

Note: 6. The capacitor value of the positive and the negative output is identical.

EMC RECOMMENDED CIRCUIT

Figure 3
Single Output Models

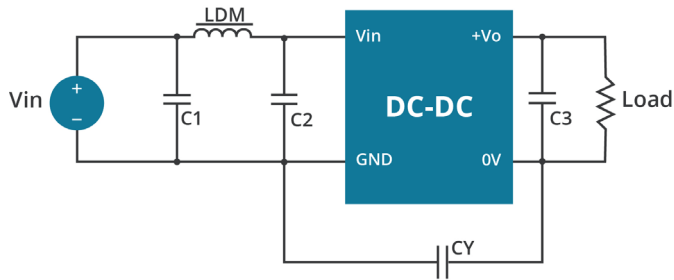

Figure 4
Dual Output Models

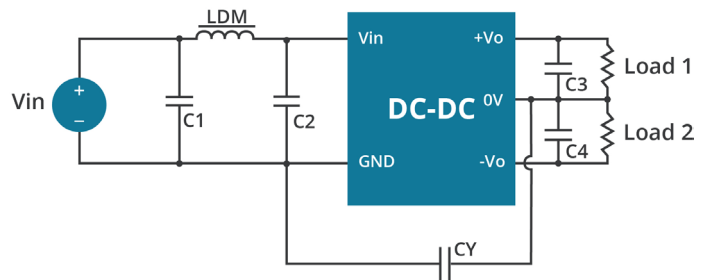

Table 3

Recommended External Circuit Components			
Vin (Vdc)	5	12, 15, 24	
Vo (Vdc)	all output models	12, 15, 24	±12, ±15, ±24
C1 / C2	4.7 μF / 16 V	4.7 μF / 50 V	4.7 μF / 50 V
CY	270 pF / 2 kV	270 pF / 2 kV	270 pF / 2 kV
C3 / C4	refer to the Co in Tables 1, 2		
LDM	6.8 μH	6.8 μH	6.8 μH

REVISION HISTORY

rev.	description	date
1.0	initial release	07/26/2021
1.01	series expanded with 5 Vdc input models	05/24/2022
1.02	CE removed	11/04/2022

The revision history provided is for informational purposes only and is believed to be accurate.



CUI INC

a bel group

Headquarters
20050 SW 112th Ave.
Tualatin, OR 97062
800.275.4899

Fax 503.612.2383
cui.com
techsupport@cui.com

CUI offers a two (2) year limited warranty. Complete warranty information is listed on our website.

CUI reserves the right to make changes to the product at any time without notice. Information provided by CUI is believed to be accurate and reliable. However, no responsibility is assumed by CUI for its use, nor for any infringements of patents or other rights of third parties which may result from its use.

CUI products are not authorized or warranted for use as critical components in equipment that requires an extremely high level of reliability. A critical component is any component of a life support device or system whose failure to perform can be reasonably expected to cause the failure of the life support device or system, or to affect its safety or effectiveness.