

EXLA1V08

Automotive high current molded inductor



Product features

- High current carrying capacity
- AEC-Q200
- Low DCR, high efficiency
- Magnetically shielded, low EMI
- Soft saturation
- Inductance range from 3.3 μ H to 10 μ H
- Current range from 8.7 A to 20 A
- 9.2 mm x 8.8 mm footprint surface mount package in a 8.0 mm height
- Alloy powder core material
- Moisture Sensitivity Level (MSL) 1

Applications

- LED lighting
- Advanced driver assistance systems (ADAS)
- Adaptive cruise control (ACC)
- Collision avoidance
- Infotainment and cluster electronics
- Battery management systems (BMS)
- Electric pumps, motor control and auxiliaries
- Powertrain control module (PCU)/Engine control module (ECM)
- Electronic Control Units (ECU)

Environmental compliance and general specifications

- Operating temperature range: -55 °C to +155 °C (ambient plus self-temperature rise)
- Storage temperature range (component): -55 °C to +155 °C
- Solder reflow temperature: J-STD-020 (latest revision) compliant



Product specifications

| Part number ⁴ | OCL ¹ (μH) $\pm 20\%$ | I_{rms} ² (A) | I_{sat} ³ (A) | DCR (m Ω) typical @ +25 °C | DCR (m Ω) maximum @ +25 °C | D (mm) ± 0.3 |
|--------------------------|--|-----------------------------------|-----------------------------------|---------------------------------------|---------------------------------------|---------------------|
| EXLA1V0808-3R3-R | 3.3 | 18 | 20 | 6.6 | 7.3 | 6.9 |
| EXLA1V0808-4R7-R | 4.7 | 14.6 | 17 | 8.9 | 9.8 | 6.9 |
| EXLA1V0808-6R8-R | 6.8 | 11.3 | 12.5 | 13 | 14.3 | 6.9 |
| EXLA1V0808-100-R | 10 | 8.7 | 10 | 20.8 | 22.9 | 6.9 |

- Open circuit inductance (OCL) test parameters: 100 kHz, 0.1 V_{rms}, 0.0 Adc, +25 °C
- I_{rms} : Heat rated current (I_{rms}) will cause the part temperature rise approximately ΔT of 40 °C. Circuit design, component, PCB trace size and thickness, airflow and other cooling provisions all affect the part temperature. Part temperature should be verified in the end application. The part temperature (ambient + temp rise) should not exceed +155 °C under worst case operating conditions.

- I_{sat} : Peak current for approximately 30% rolloff @ +25 °C
- Part number definition: EXLA1V0808-xxx-R
EXLA1V0808 = Product code and size
xxx= inductance value in μH , R= decimal point,
If no R is present then third digit equals the number of zeros
-R suffix = RoHS compliant
- Rated operating voltage (across inductor) 40 V ref.

Mechanical parameters, schematic, pad layout (mm)

EXLA1V0808

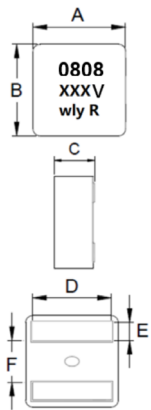

Recommended pad layout

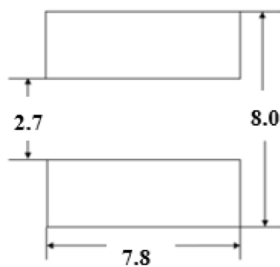

Schematic

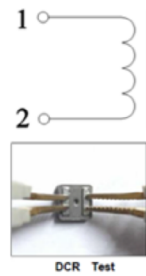

| Part number | A | B | C | D | E | F |
|------------------|----------------|----------------|----------------|----------------|----------------|----------------|
| EXLA1V0808-xxx-R | 8.9 \pm 0.30 | 8.5 \pm 0.30 | 7.7 \pm 0.20 | See spec table | 1.8 \pm 0.20 | 3.5 \pm 0.30 |

Part marking: 0808

xxx= Inductance value in μH (R= decimal point, if no R is present last digit equals number of zeros, V= vehicle, wly R= lot code)

All soldering surfaces to be coplanar within 0.1 millimeters

Tolerances are ± 0.3 millimeters unless stated otherwise

Dimensions of recommended PCB layout are reference only.

Pad layout tolerances are ± 0.1 millimeters unless stated otherwise

Four terminal kelvin-clip recommended for DCR testing

Traces or vias underneath the inductor is not recommended.

Packaging information (mm)

Supplied in tape and reel packaging, 450 parts per 13" diameter reel (EIA-481 compliant)

Drawing not to scale

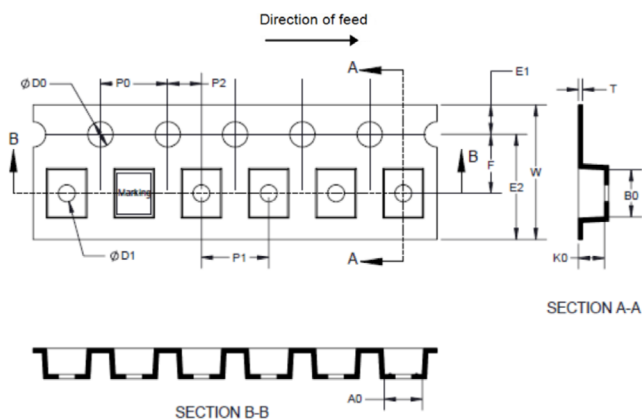

| | |
|------------------|-------|
| $W \pm 0.30$ | 24 |
| $F \pm 0.1$ | 7.5 |
| $E1 \pm 0.10$ | 1.75 |
| $E2$ Min | 22.25 |
| $P0 \pm 0.10$ | 4 |
| $P1 \pm 0.10$ | 16 |
| $P2 \pm 0.1$ | 2 |
| $D0 + 0.10 / -0$ | 1.5 |
| $D1 + 0.10 / -0$ | 1.5 |
| $A0 \pm 0.10$ | 9.4 |
| $B0 \pm 0.10$ | 8.9 |
| $K0 \pm 0.10$ | 8.5 |
| $T \pm 0.05$ | 0.35 |

Inductance and temperature rise vs. current

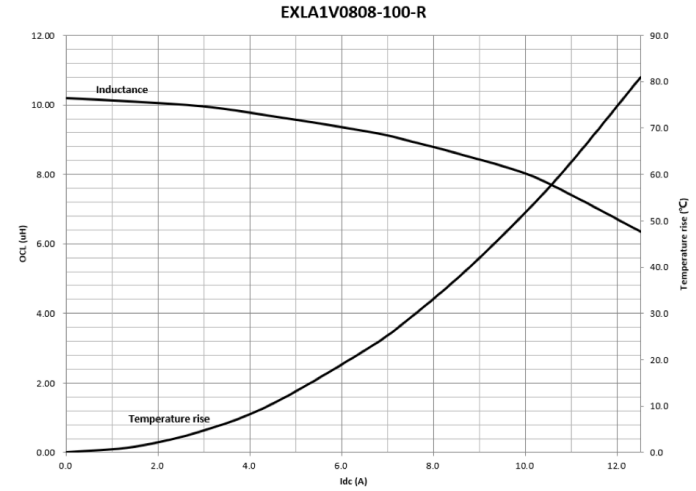
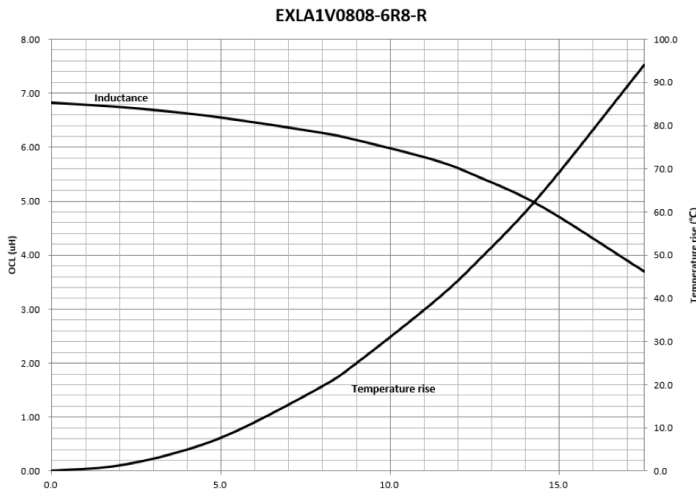
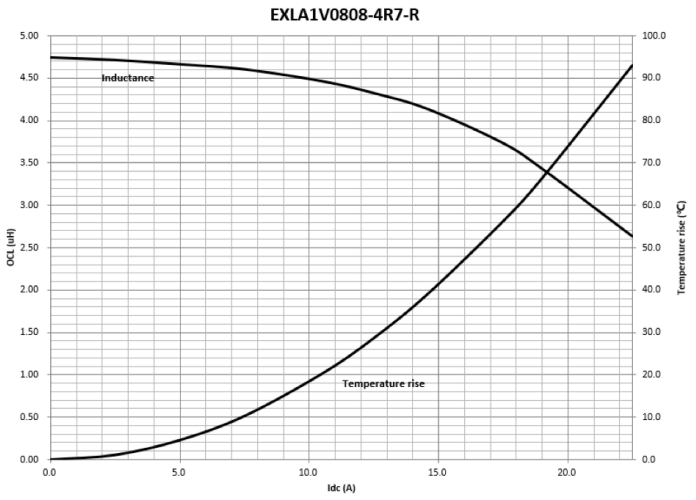
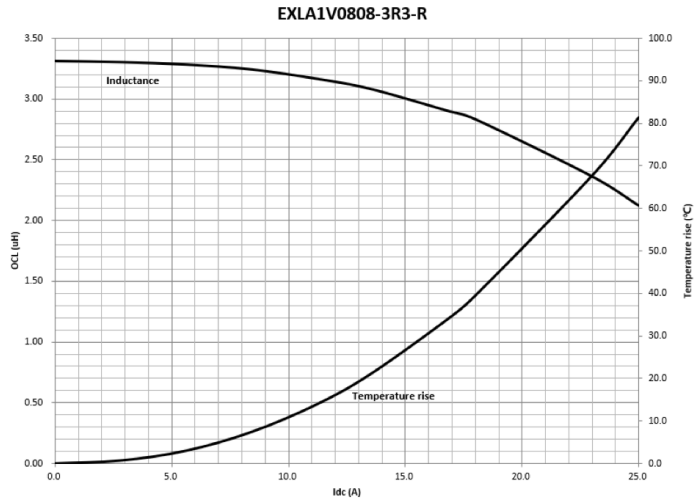

Inductance and impedance vs frequency curve

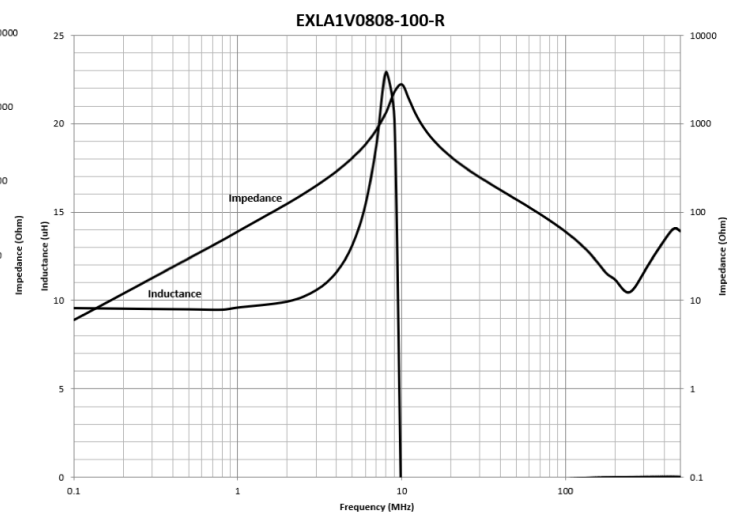
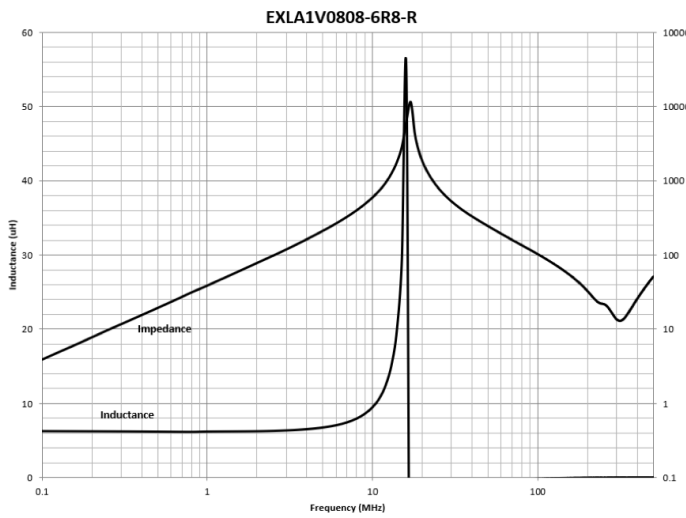
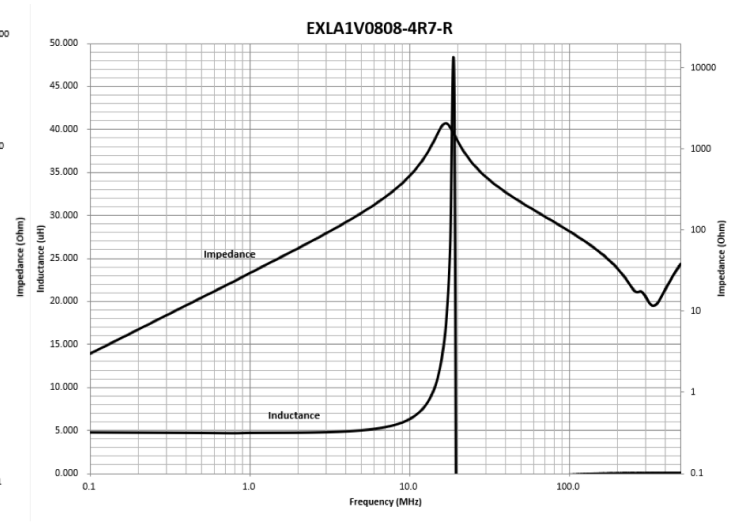
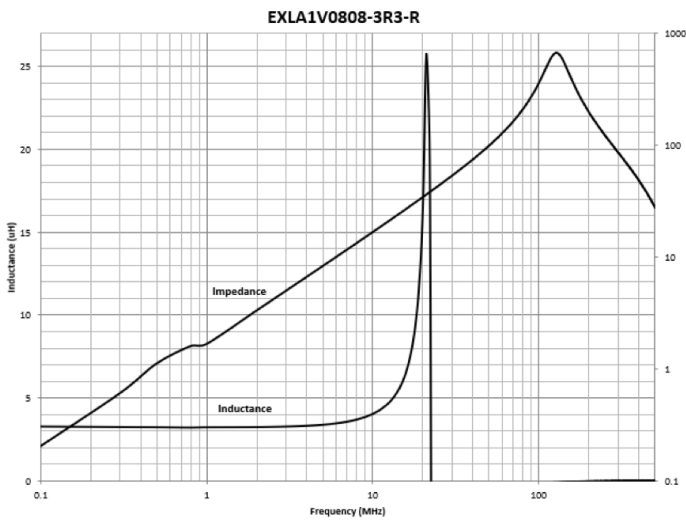

Solder reflow profile

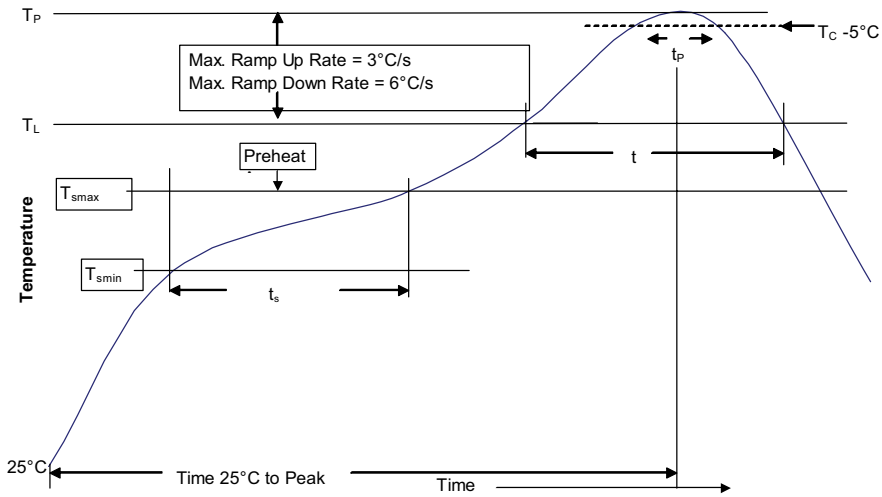

Table 1 - Standard SnPb solder (T_C)

| Package thickness | Volume mm^3 <350 | Volume mm^3 \geq 350 |
|-------------------|---------------------------|---------------------------------|
| <2.5 mm | 235 °C | 220 °C |
| \geq 2.5 mm | 220 °C | 220 °C |

Table 2 - Lead (Pb) free solder (T_C)

| Package thickness | Volume mm^3 <350 | Volume mm^3 350 - 2000 | Volume mm^3 >2000 |
|-------------------|---------------------------|---------------------------------|----------------------------|
| <1.6 mm | 260 °C | 260 °C | 260 °C |
| 1.6 – 2.5 mm | 260 °C | 250 °C | 245 °C |
| >2.5 mm | 250 °C | 245 °C | 245 °C |

Reference J-STD-020

| Profile feature | Standard SnPb solder | Lead (Pb) free solder |
|---|----------------------|-----------------------|
| Preheat and soak | | |
| • Temperature min. (T_{smin}) | 100 °C | 150 °C |
| • Temperature max. (T_{smax}) | 150 °C | 200 °C |
| • Time (T_{smin} to T_{smax}) (t_s) | 60-120 seconds | 60-120 seconds |
| Ramp up rate T_L to T_p | 3 °C/ second max. | 3 °C/ second max. |
| Liquidous temperature (T_L) | 183 °C | 217 °C |
| Time (t_L) maintained above T_L | 60-150 seconds | 60-150 seconds |
| Peak package body temperature (T_p)* | Table 1 | Table 2 |
| Time (t_p)* within 5 °C of the specified classification temperature (T_C) | 20 seconds* | 30 seconds* |
| Ramp-down rate (T_p to T_L) | 6 °C/ second max. | 6 °C/ second max. |
| Time 25 °C to peak temperature | 6 minutes max. | 8 minutes max. |

* Tolerance for peak profile temperature (T_p) is defined as a supplier minimum and a user maximum.

Life Support Policy: Eaton does not authorize the use of any of its products for use in life support devices or systems without the express written approval of an officer of the Company. Life support systems are devices which support or sustain life, and whose failure to perform, when properly used in accordance with instructions for use provided in the labeling, can be reasonably expected to result in significant injury to the user.

Eaton reserves the right, without notice, to change design or construction of any products and to discontinue or limit distribution of any products. Eaton also reserves the right to change or update, without notice, any technical information contained in this bulletin.

Eaton
Electronics Division
1000 Eaton Boulevard
Cleveland, OH 44122
United States
Eaton.com/electronics

© 2022 Eaton
All Rights Reserved
Printed in USA
Publication No. ELX1250 BU-ELX22114
November 2022

Eaton is a registered trademark.
All other trademarks are property of their respective owners.

Follow us on social media to get the latest product and support information.

