

## CLX6F-PKW: PLCC6 3 IN 1 SMD LED



### PRODUCT DESCRIPTION

These SMD LEDs are packaged in an industry standard PLCC6 package. These high reliability and high brightness LEDs are designed to work in a wide range of environmental condition and are ideally suited for use in illumination applications.

Its wide viewing angle makes these LEDs ideally suited for channel letter, or general backlighting and illumination applications. The flat top emitting surface makes it easy for these LEDs to mate with light pipes.

### FEATURES

- Size (mm): 3.5 x 3.4 x 2.8
- Luminous Intensity (mcd)  
CLX6F-PKW:(6300-11300)
- Moisture Sensitivity Level: 5a
- Lead-Free
- RoHS Compliant

### APPLICATIONS

- Architecture Lighting
- Channel Letter
- Backlight

**ABSOLUTE MAXIMUM RATINGS ( $T_A = 25^\circ\text{C}$ )**

Items	Symbol	Absolute Maximum Rating	Unit
Forward Current <sup>Note 1</sup>	$I_F$	3 x 70	mA
Peak Forward Current <sup>Note 2</sup>	$I_{FP}$	3 x 200	mA
Reverse Voltage	$V_R$	5	V
Power Dissipation	$P_D$	3 x 280	mW
Operation Temperature	$T_{opr}$	-40 ~ +85	$^\circ\text{C}$
Storage Temperature	$T_{stg}$	-40 ~ +100	$^\circ\text{C}$
Junction Temperature	$T_J$	110	$^\circ\text{C}$
Junction/Ambient 1 chip on	$R_{THJA}$	220	$^\circ\text{C}/\text{W}$
Junction/Solder Point 1 chip on	$R_{THJS}$	140	$^\circ\text{C}/\text{W}$
Electrostatic Discharge Classification (MIL-STD-883E)	ESD	1000V	

**Note:**

1. Single-color light
2. Pulse width  $\leq 0.1$  msec, duty  $\leq 1/10$ .

**TYPICAL ELECTRICAL & OPTICAL CHARACTERISTICS ( $T_A = 25^\circ\text{C}$ )**

Characteristics	Condition	Symbol	Values	Unit
Spectral bandwidth at 50% $I_{REL}$ max	$I_F = 3 \times 35\text{mA}$	$\Delta \lambda$	81	nm
Forward Voltage	$I_F = 3 \times 35\text{mA}$	$V_{F(avg)}$	3.3	V
		$V_{F(max)}$	4.0	V
Luminous Intensity	$I_F = 3 \times 35\text{mA}$	$I_{V(min)}$	6300	mcd
		$I_{V(avg)}$	9000	mcd
Luminous Flux(Reference)	$I_F = 3 \times 35\text{mA}$	$\Phi_{V(avg)}$	23	lm
Reverse Current (max)	$V_R = 5 \text{ V}$	$I_R$	10	$\mu\text{A}$

\* Continuous reverse voltage can cause LED damage.

## INTENSITY BIN LIMIT

PC Amber(3 x 35 mA) - CLX6F-PKW		
Bin Code	Min.(mcd)	Max.(mcd)
1k1m	6300	8000
X	7100	9000
1n1p	8000	10100
Y	9000	11300

\* Tolerance of measurement of luminous intensity is  $\pm 10\%$

## COLOR BIN LIMIT

PC Amber (3 x 35 mA) - CLX6F-PKW		
Bin Code	Min.(nm)	Max.(nm)
V0	0.5622	0.4372
	0.5843	0.4152
	0.5705	0.4111
	0.5499	0.4249

\* Tolerance of measurement of the color coordinates is  $\pm 0.02$

## CIE CHROMATICITY DIAGRAM

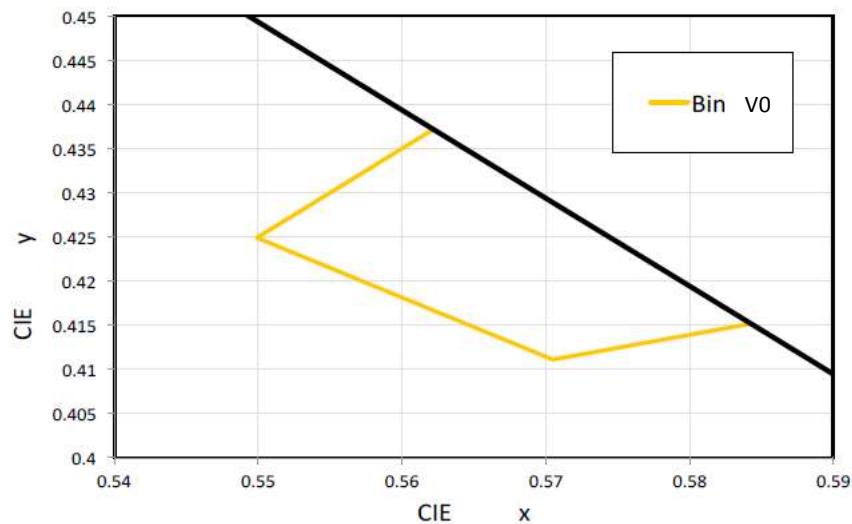

## ORDER CODE TABLE

Color	Kit Number	Luminous Intensity (mcd)		Dominant Wavelength (nm)	Package
		Min.	Max.		
PC Amber	CLX6F-PKW-C1k1mYV0V03	6300	11300	V0	Reel

### Notes:

- The above kit numbers represent order codes that include multiple intensity-bin and color-bin codes. Only one intensity-bin code and one color-bin code will be shipped on each bulk. Single intensity-bin code and single color-bin codes will not be orderable.
- Please refer to the [HB LED Lamp Reliability Test Standards](#) document for reliability test conditions.
- Please refer to the [HB LED Lamp Soldering & Handling](#) document for information about how to use this LED product safely.

**GRAPHS**

The data below are collected from statistical figures that do not necessarily correspond to the actual parameters of each single LED. Hence, these data will be changed without further notice.

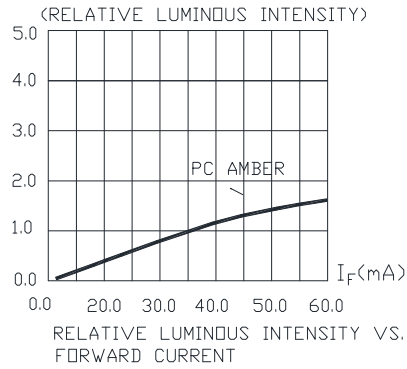
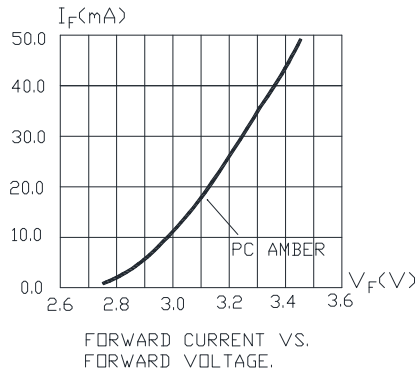
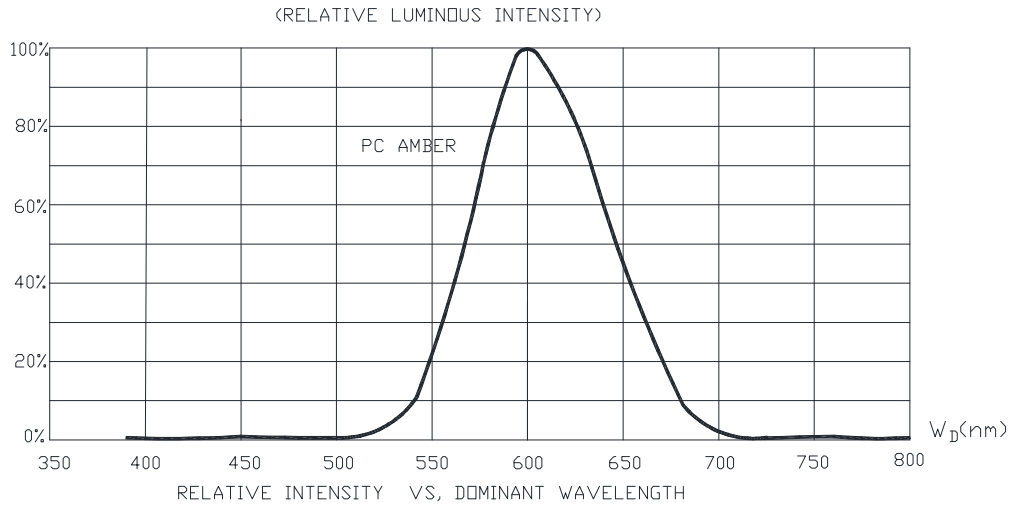

**GRAPHS**

The data below are collected from statistical figures that do not necessarily correspond to the actual parameters of each single LED. Hence, these data will be changed without further notice.

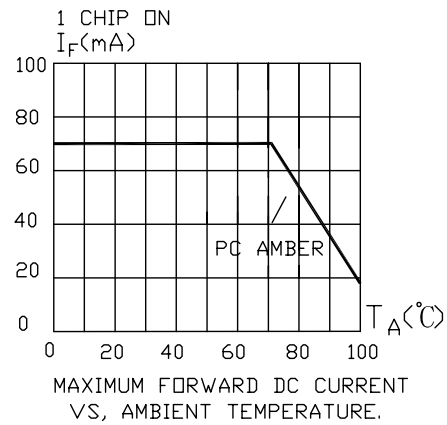
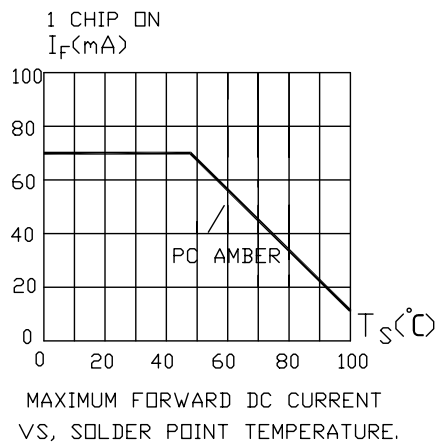
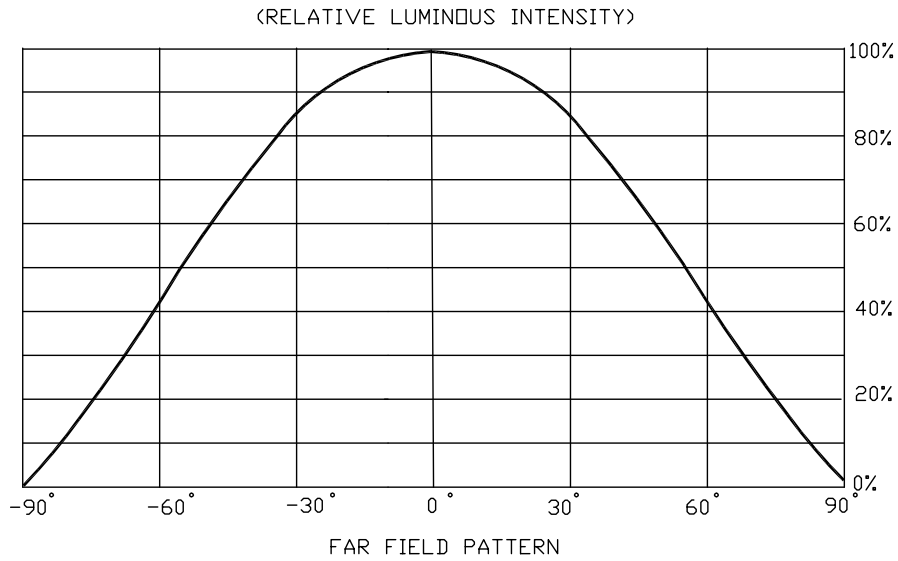

## MECHANICAL DIMENSIONS

All dimensions are in mm.

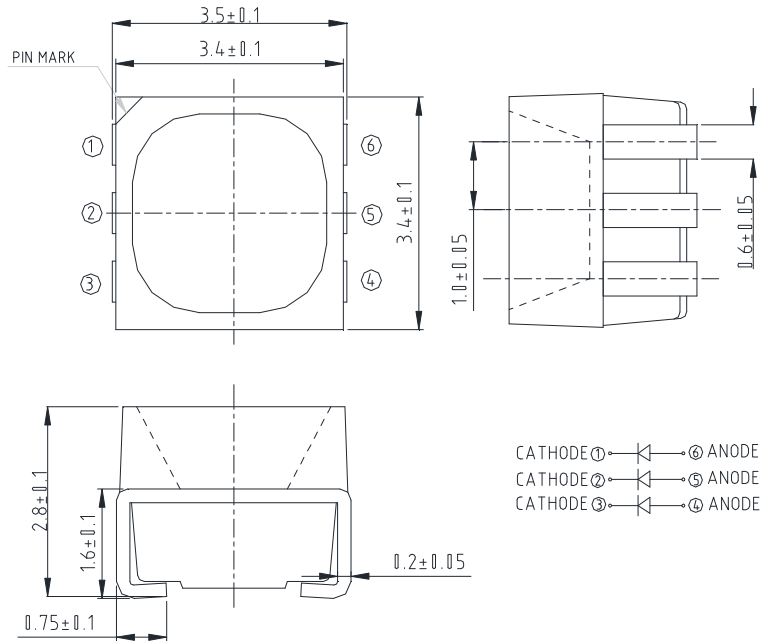

## NOTES

### RoHS Compliance

The levels of RoHS restricted materials in this product are below the maximum concentration values (also referred to as the threshold limits) permitted for such substances, or are used in an exempted application, in accordance with EU Directive 2011/65/EC (RoHS2), as implemented January 2, 2013. RoHS Declarations for this product can be obtained from your Cree LED representative or from the [Product Ecology](#) section of the Cree LED website.

### Vision Advisory

**WARNING:** Do not look at an exposed lamp in operation. Eye injury can result.

## KIT NUMBER SYSTEM

Cree LED lamps are tested and sorted into performance bins. A bin is specified by ranges of color, forward voltage, and brightness. Sorted LEDs are packaged for shipping in various convenient options.

Cree LEDs are sold by order codes in combinations of bins called kits. Order codes are configured in the following manner:

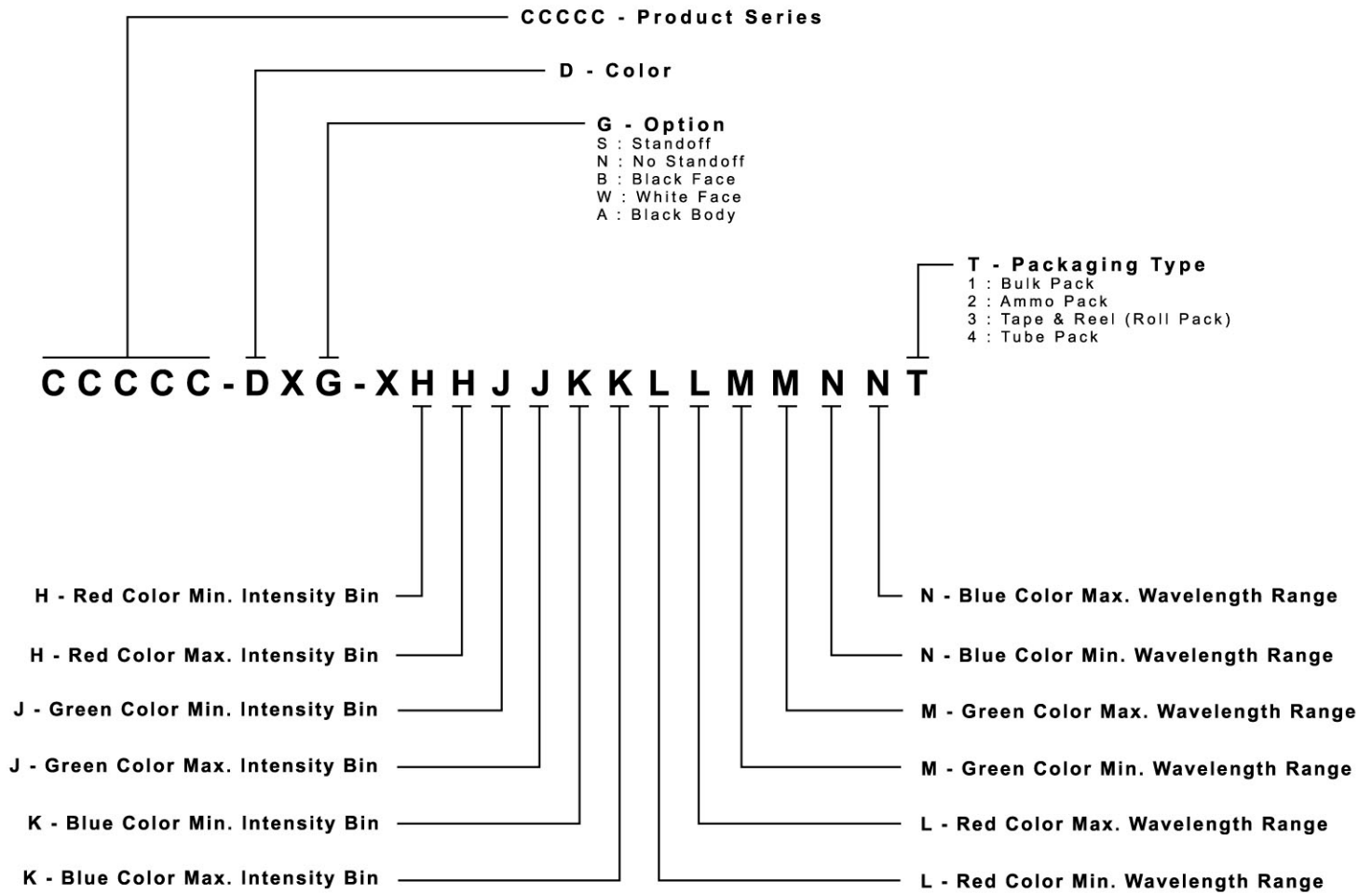



## REFLOW SOLDERING

- The CLX6F-PKW is rated as a MSL 5a product.
- The recommended floor life out of bag is 24hrs.
- The temperature profile is as below.

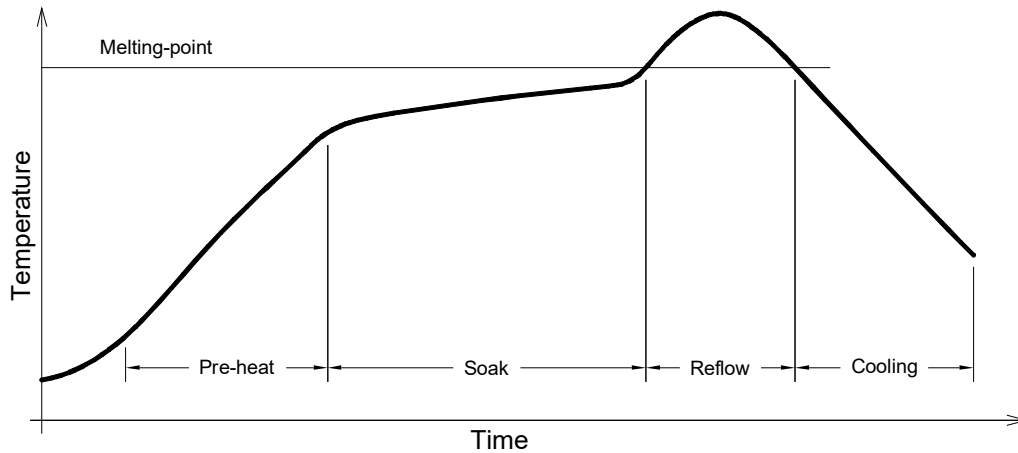

Use only with CLX6F-PKW

Solder
Average ramp-up rate = 4°C/s max
Preheat temperature = 150°C ~200°C
Preheat time = 120s max
Ramp-down rate = 6°C/s max
Peak temperature = 250°C max
Time within 5°C of actual Peak Temperature = 10s max
Duration above 217°C is 60s max

- The packaging sizes of these SMD products are very small and the resin is still soft after solidification. Users are required to handle with care. Never touch the resin surface of SMD products.
- To avoid damaging the product's surface and interior device, it is recommended to choose a special nozzle to pick up the SMD products during the process of SMT production. If handling is necessary, take special care when picking up these products. The following method is necessary:
- Please refer to the [HB LED Lamp Soldering & Handling](#) document for information about how to use this LED product safely.

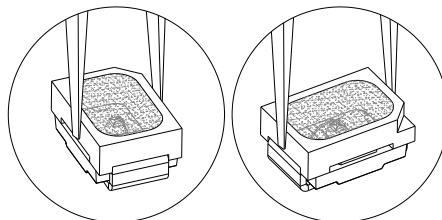

## PACKAGING

- The LEDs are packed in cardboard boxes after packaging in normal or anti-electrostatic bags.
- Cardboard boxes will be used to protect the LEDs from mechanical shock during transportation.
- The boxes are not water resistant, and they must be kept away from water and moisture.
- The reel pack is applied in SMD LED.
- Max 2800 pcs per reel.

