



# TAOGLAS®



# Datasheet

DSRC 5900MHz Ceramic Chip Antenna

**Part No:**  
CA.51

**Description:**

5.9GHz DSRC Ceramic SMD Mount Chip Antenna

**Features:**

5850MHz to 5925MHz  
Peak Gain 2dBi  
Stable and Reliable Performance  
Linear Polarized & High Efficiency  
Low Profile, Compact Size  
Manufactured in an IATF16949 Approved Facility  
Dimensions: 1.6\*0.8\*0.3mm  
RoHS & REACH Compliant

1. Introduction	3
2. Specifications	4
3. Antenna Characteristics	5
4. Radiation Patterns	7
5. Mechanical Drawing – Antenna	9
6. Antenna Integration Guide	10
7. Soldering Conditions	17
8. Packaging	18
<hr/>	
Changelog	19

Taoglas makes no warranties based on the accuracy or completeness of the contents of this document and reserves the right to make changes to specifications and product descriptions at any time without notice. Taoglas reserves all rights to this document and the information contained herein. Reproduction, use or disclosure to third parties without express permission is strictly prohibited.



# 1. Introduction



The Taoglas CA.51 is a ceramic chip antenna specifically designed for 5.9GHz DSRC applications. Primarily designated for vehicle safety applications, DSRC offers high-speed, low-latency wireless communication over short distances. The CA.51 exhibits high-efficiency in a miniature SMD mount ceramic antenna with a small footprint requirement. This ceramic chip antenna uses the main PCB as its ground plane, thereby increasing antenna efficiency and decreasing the assembly cost. It is tuned for different PCB sizes by simply changing the value of the matching circuit. At 1.6mm\*0.8mm\*0.3mm, it is one of the smallest antennas available worldwide. This antenna is delivered on tape and reel.

This antenna can be mounted with no performance degradation in either orientation if the antenna is soldered correctly via surface mounting. Please see the integration instructions section for further detail regarding the optimum way to integrate this antenna into your device.

## Applications:

- IEEE 802.11p (WAVE- Wireless Access in the Vehicular Environment)
- DSRC (Dedicated Short-Range Communication) systems for the automotive industry

For support on how to integrate and test this antenna within your application, or for sample requests, contact your regional Taoglas Customer Services Team.

## 2. Specifications

Antenna	
Frequency (MHz)	5850-5925 MHz
Efficiency (%)	
40 x 40 mm Ground Plane	57.08
Average Gain (dB)	
40 x 40 mm Ground Plane	-2.44 dB (typical)
Peak Gain (dBi)	
40 x 40 mm Ground Plane	2.87 dBi (typical)
VSWR	2 max.
Impedance ( $\Omega$ )	50 $\Omega$
Polarization	Linear
Radiation Pattern	Omni
Input Power(W)	2
Mechanical	
Dimensions (mm)	1.6 x 0.8 x 03
Ground plane (mm)	40 x 40 (Recommended)
Material	Ceramic
Environmental	
Temperature Range	-40°C to 85°C
Temperature Coefficient of Frequency (ppm/°C)	0±20 max. (@-40°C to 85°C)
Humidity	Non-condensing 65°C 95% RH
Moisture Sensitivity Level	3 (168 Hours)

### 3. Antenna Characteristics

#### 3.1 Return Loss

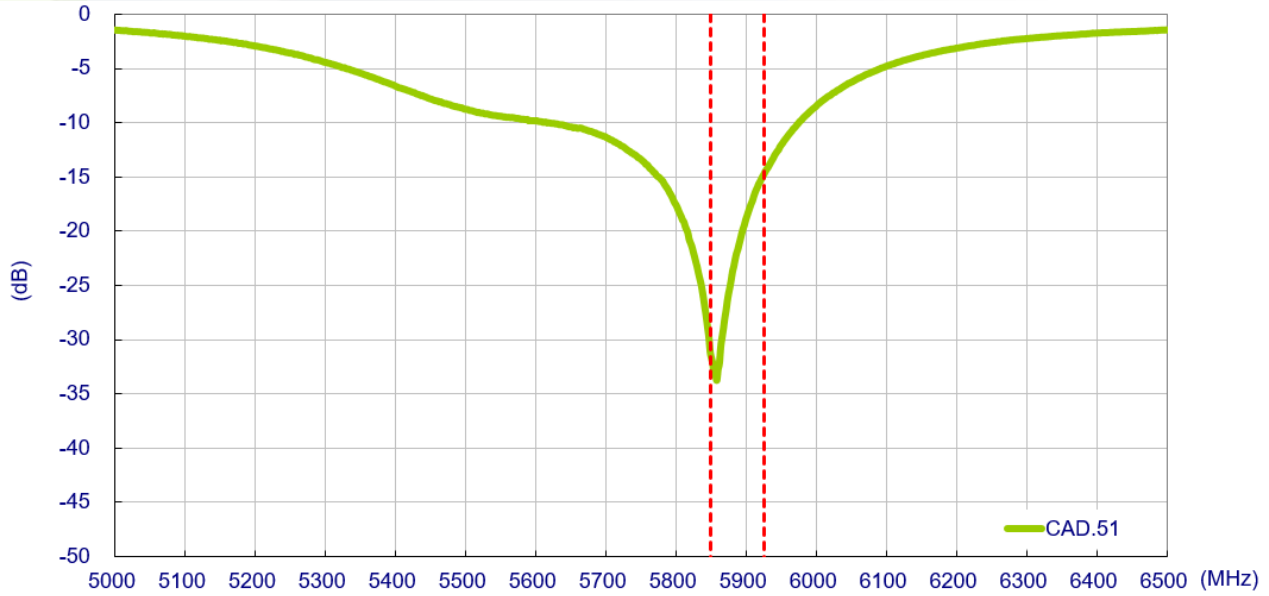

#### 3.2 Efficiency

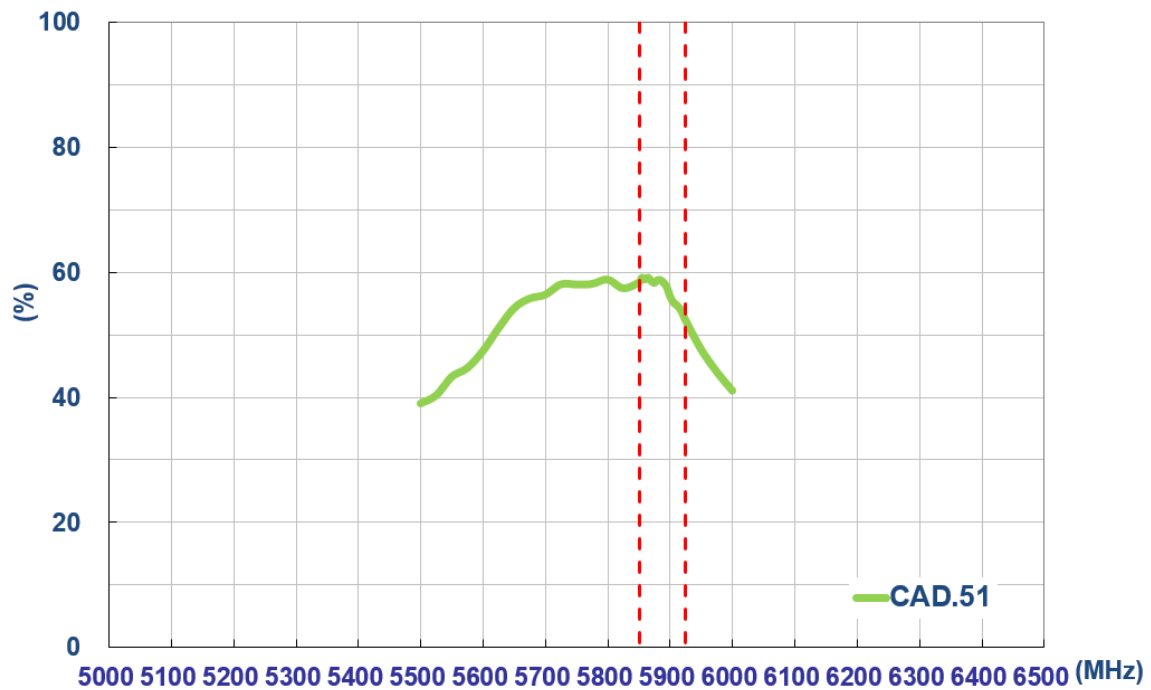

**3.3** Average Gain

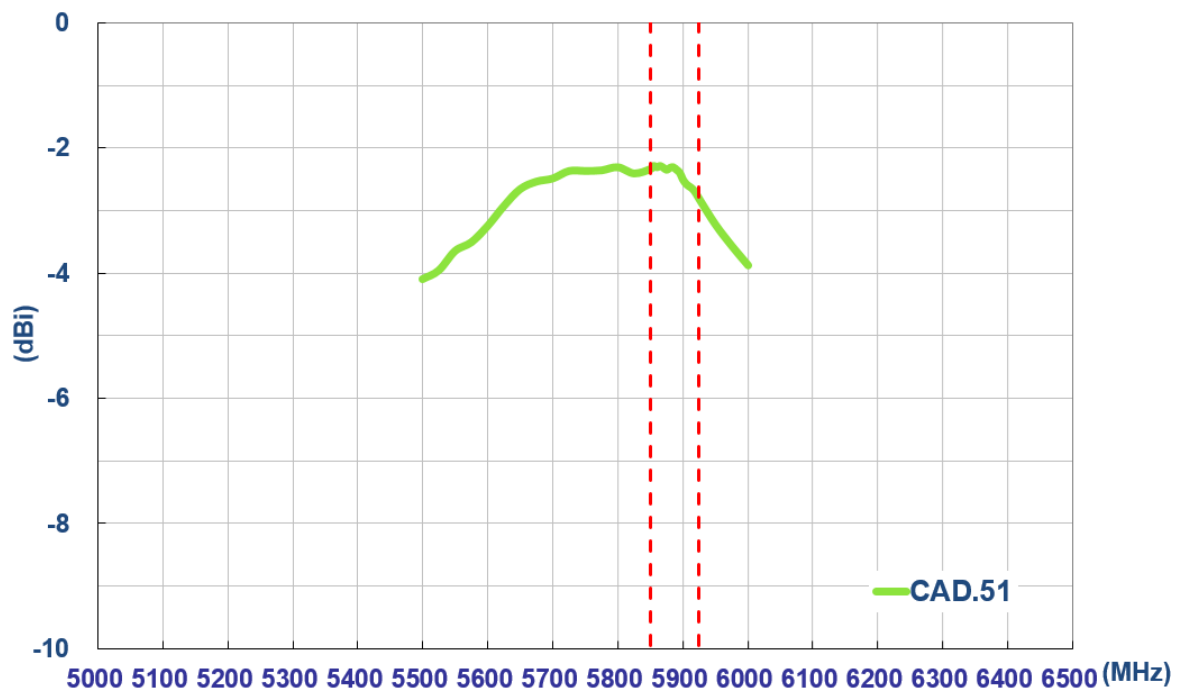

**3.4** Peak Gain



## 4. Radiation Patterns

### 4.1 Test Setup – Antenna on Evaluation Board



## 4.2 5850 - 5925MHz Radiation Patterns

XY Plane

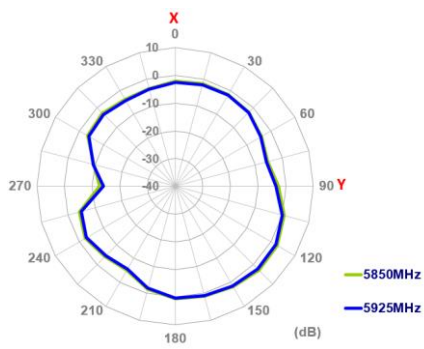

XY Plane Flipped

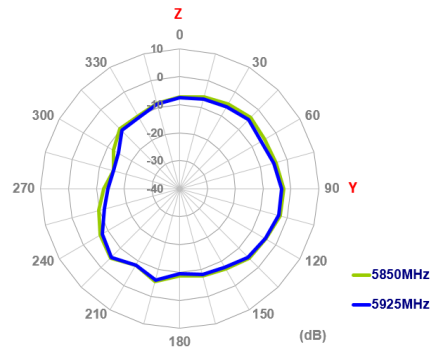

XZ Plane

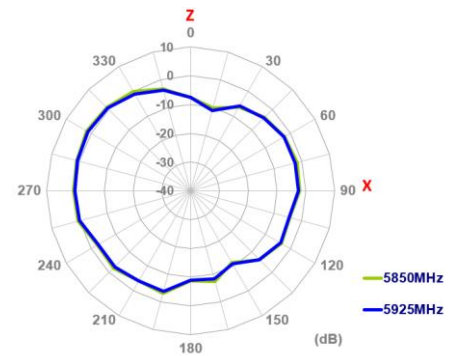

## 4.3 3D Radiation Pattern

5850MHz

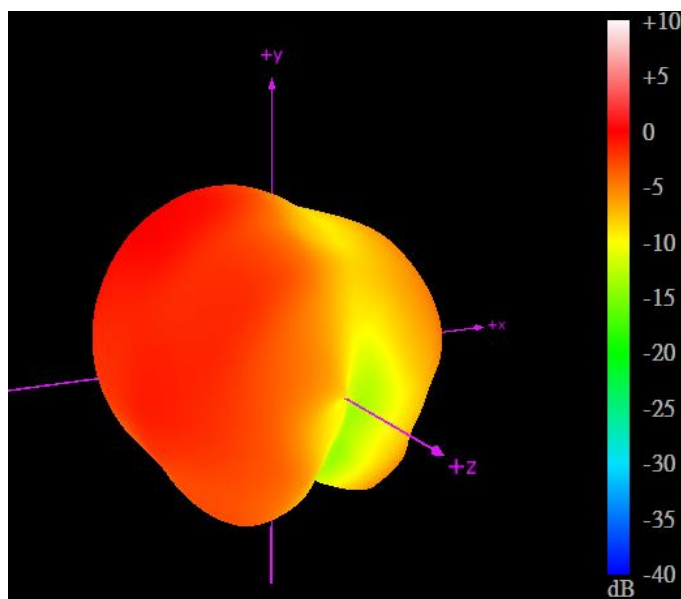

5925MHz

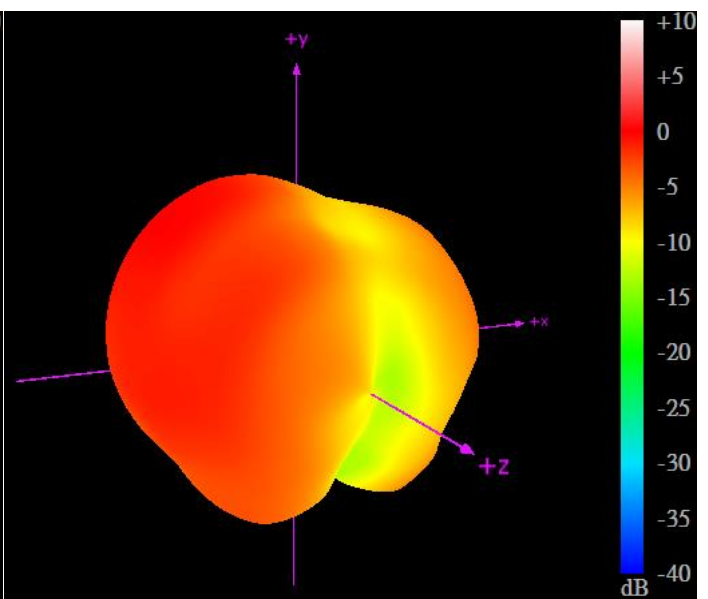



# 5. Mechanical Drawing – Antenna

## 5.1 Antenna Dimension and Drawing

Front View

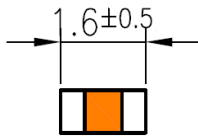

Side View

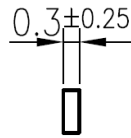

Back View

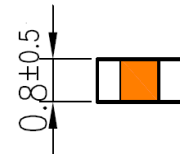

Unit: mm

## 5.2 Antenna Footprint

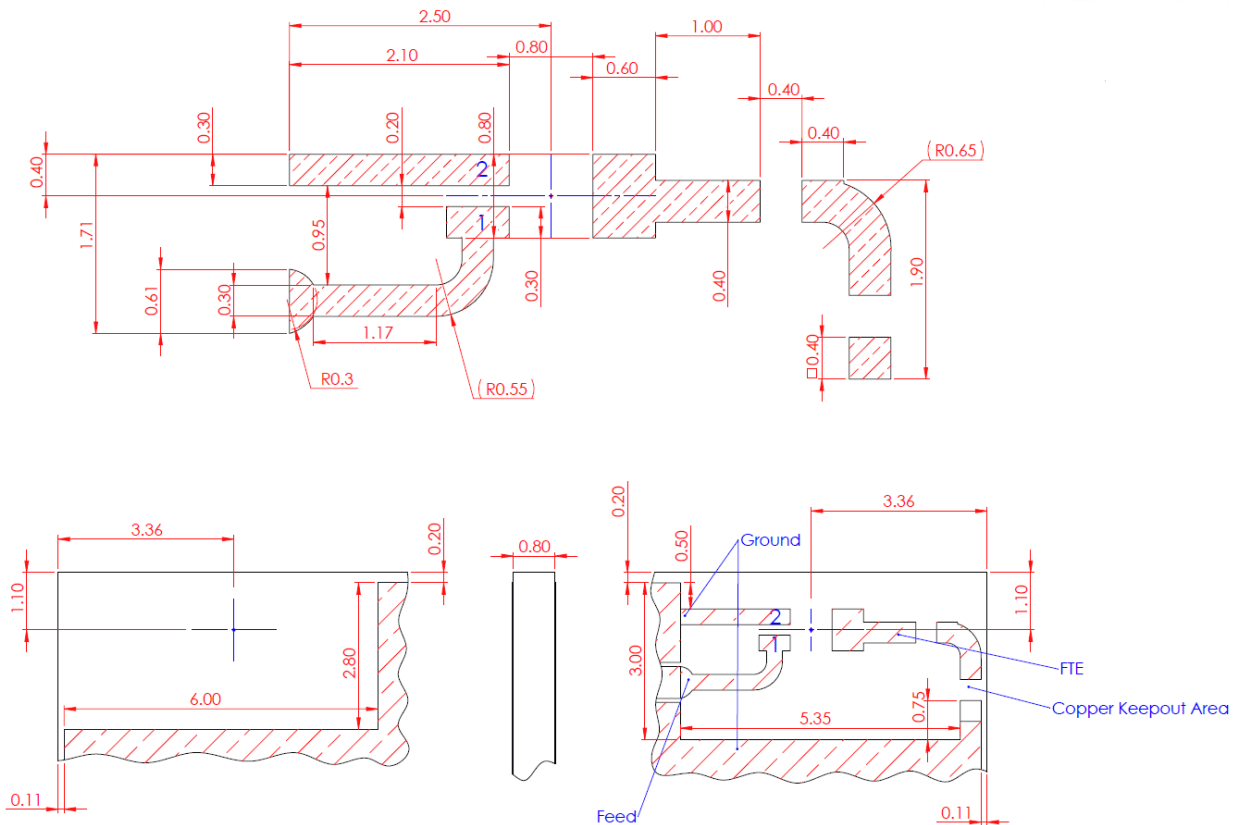

PIN	DESCRIPTION
1	Feed
2	Ground

Copper Area

\*Taoglas is able to provide CAD drawing file to customers for evaluation.

## 6. Antenna Integration Guide

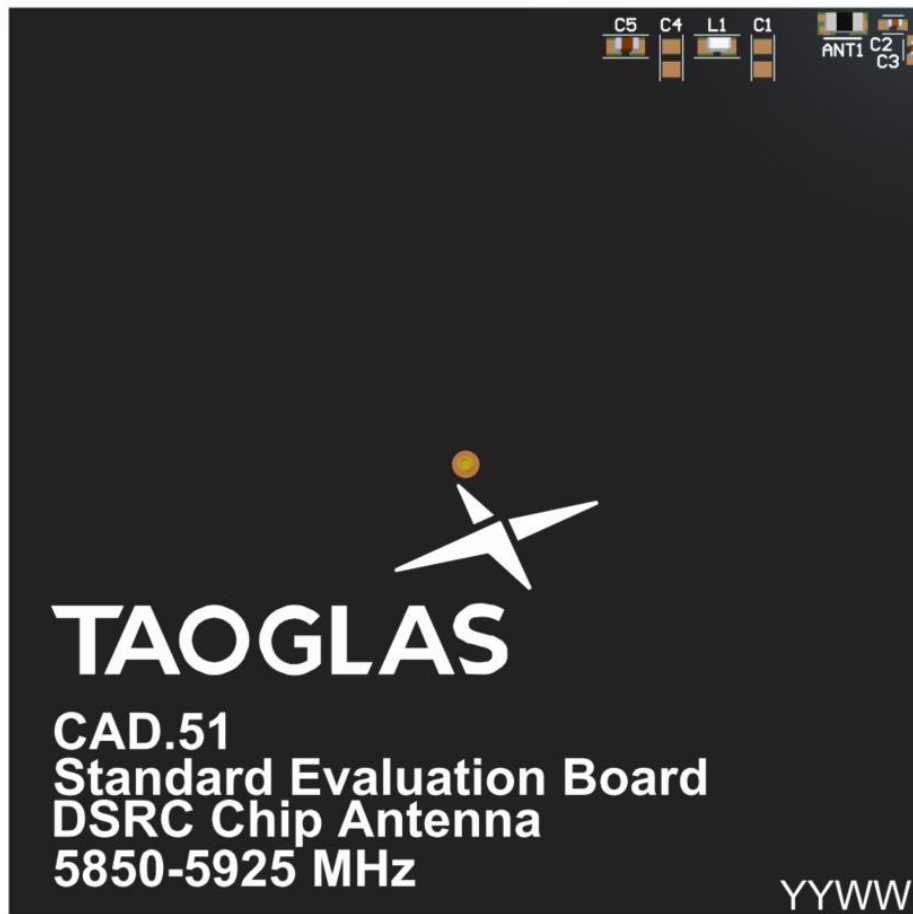
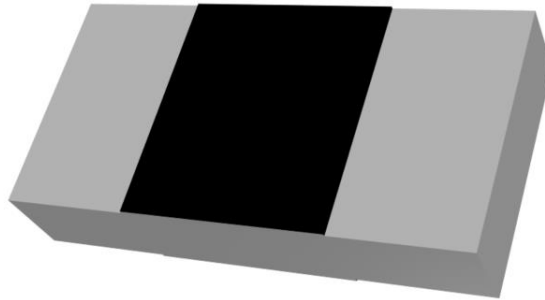

## 6.1 Schematic Symbol and Pin Definition

The circuit symbol for the antenna is shown below. The antenna has 3 pins with all three pins as functional.

Pin	Description
1	RF Feed
2	Fine Tuning Element
3	Ground

TAOGLAS\_CA.51  
ANT1

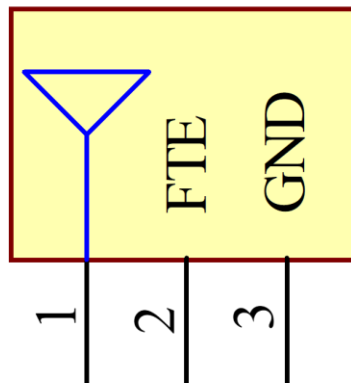

## 6.2 Antenna Integration

For any given PCB size, the antenna should ideally be placed in the corner of the PCB, to take advantage of the ground plane. Optimized matching components can be placed as shown.

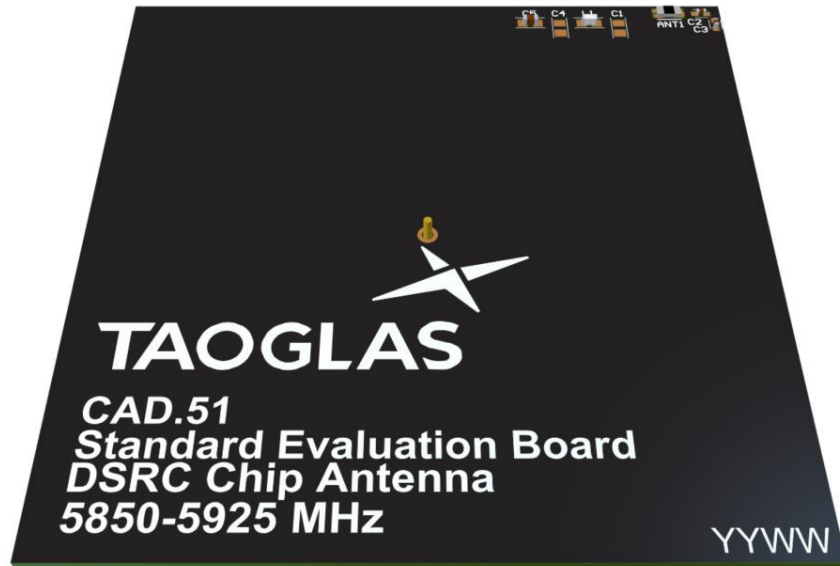

## 6.3 PCB Layout

The footprint and clearance on the PCB must meet the layout drawing in section (Footprint Drawing). Note the placement of the optimized components. L1 is placed as close as possible to the RF feed (pad 1) within RF Trace with C5 then placed tightly in series after that. C2 is placed as close as possible to the Fine-Tuning Element feed (pad 3) within the copper keep out area with C3 then placed tightly in series after that. C1 & C4 are optional components but the footprints are recommended in case it is needed.

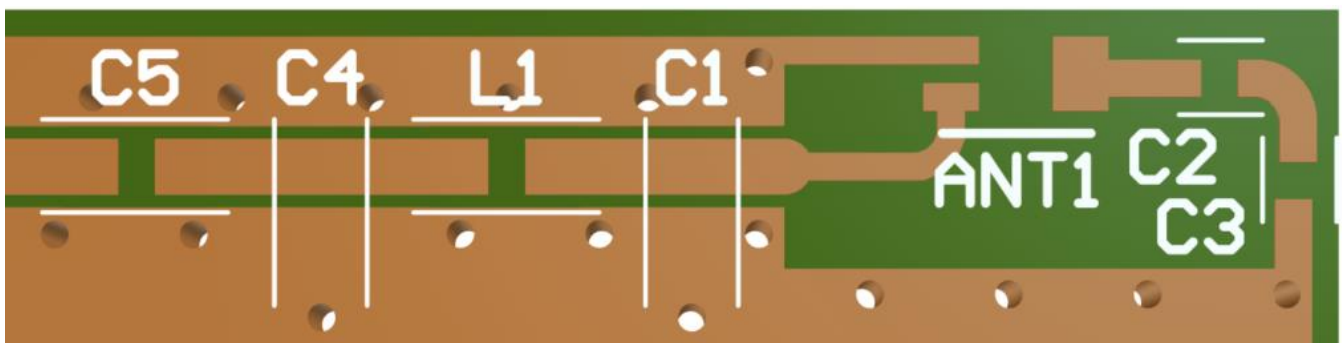
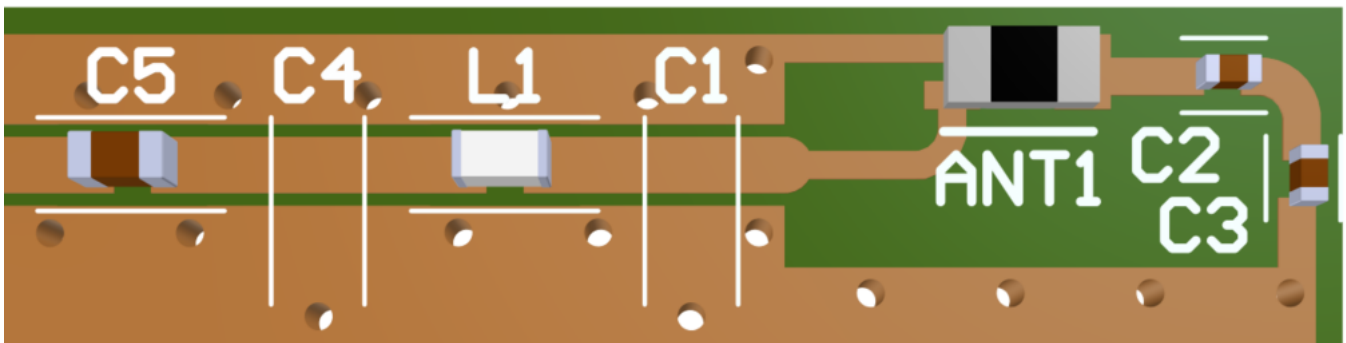

Topside

## 6.4 PCB Clearance

Below shows the antenna footprint and clearance through ALL layers on the PCB. Only the antenna pads and connections to feed and GND are present within this clearance area (marked RED). The clearance area extends to 2.8mm in length and 6mm in width from the corner of the PCB. This clearance area includes the bottom side and ALL internal layers on the PCB.

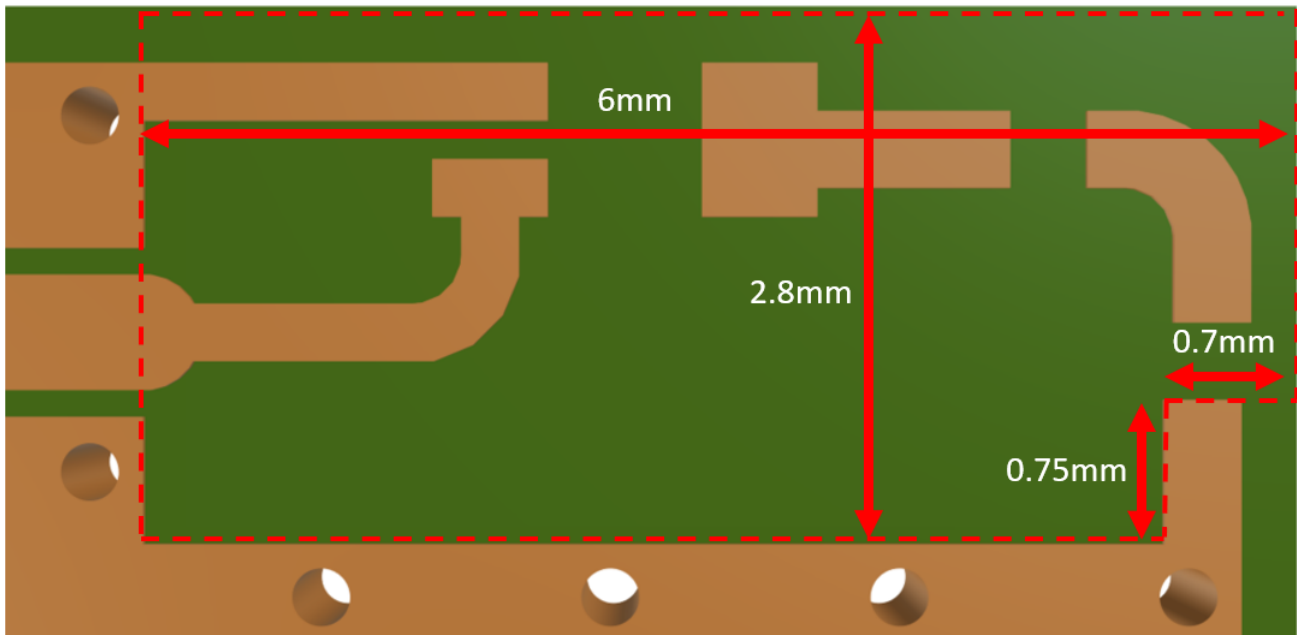

Topside

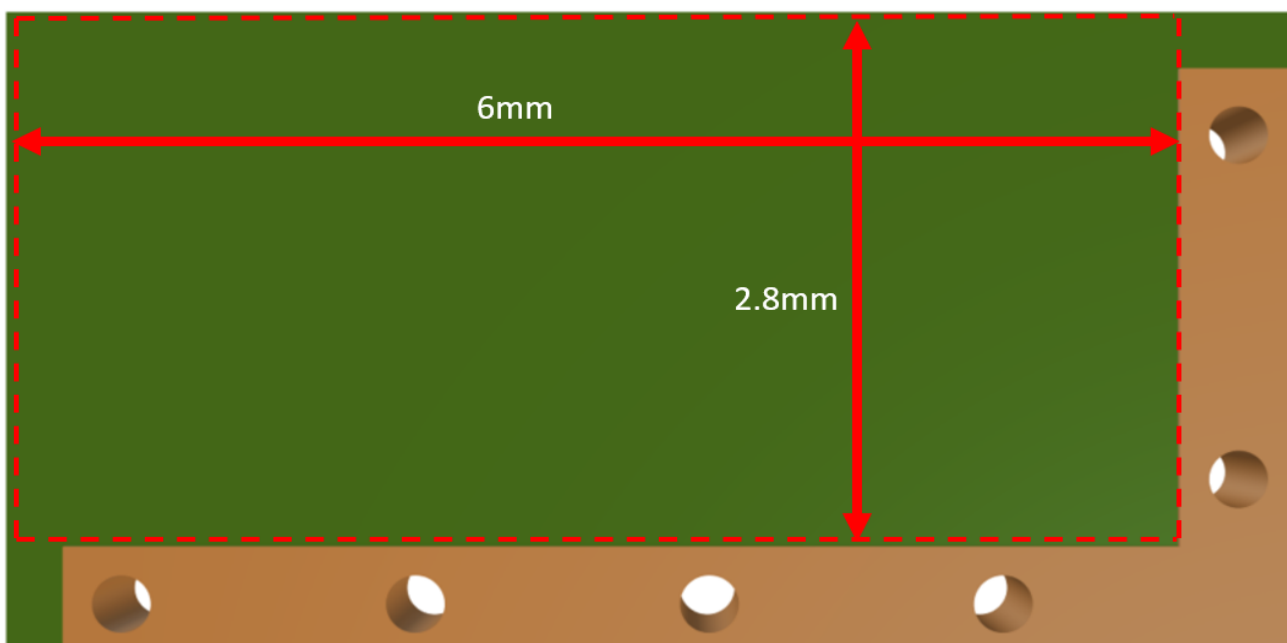

Bottom Side

6.5 Evaluation Board



Topside

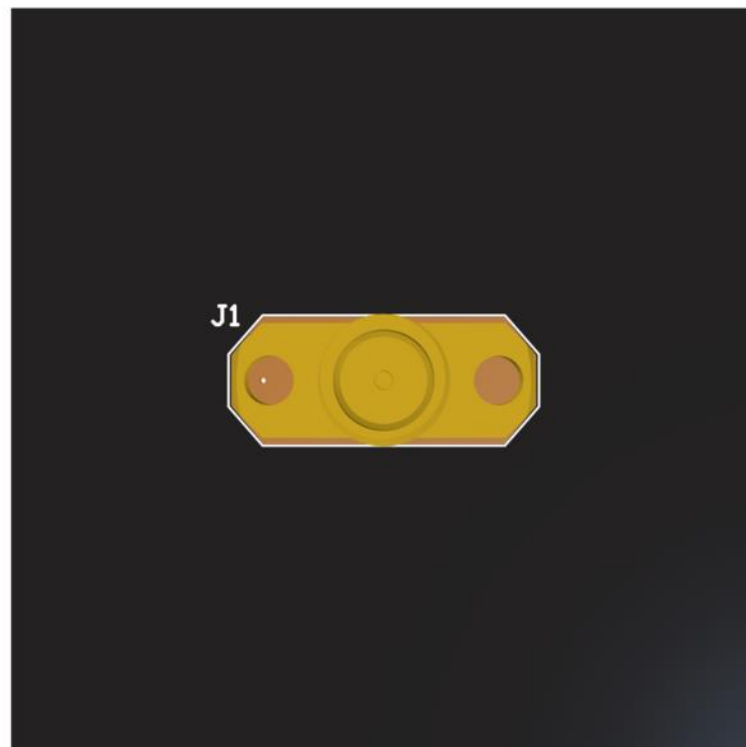

Bottom Side

## 6.6 Evaluation Board Matching Circuit

Matching Components with the CA.51 are required for the antenna to have optimal performance on the evaluation board, located outside of the ground plane in the space specified in the above images. Additional matching components may be necessary for your device, so we recommend incorporating extra component footprints, forming a “pi” network, between the antenna module and the edge of the ground plane.

Designator	Type	Value	Manufacturer	Manufacturer Part Number
C1, C4	Capacitor	Not Fitted	-	-
C2	Capacitor	6.8pF	Murata	GRM0335C1H6R8DA01D
C3	Capacitor	5.6pF	Murata	GRM0335C1E5R6CA01D
C5	Capacitor	2.7pF	Murata	GCM1555C1H2R7CA16D
L1	Inductor	2.2nH	TDK	MLK1005S2N2ST000

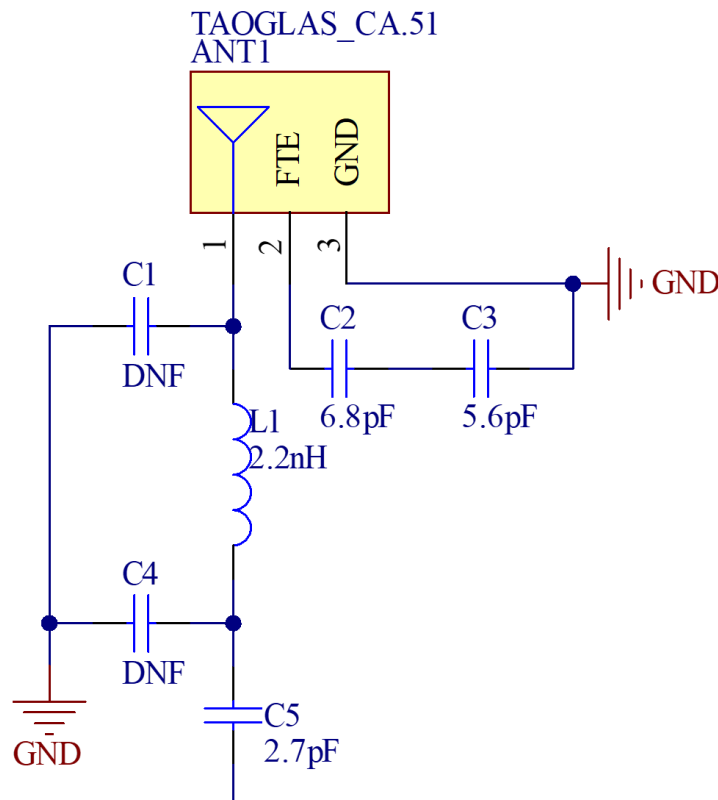



## 7. Soldering Conditions

The CA.51 can be assembled by following the recommended soldering temperatures are as follows:

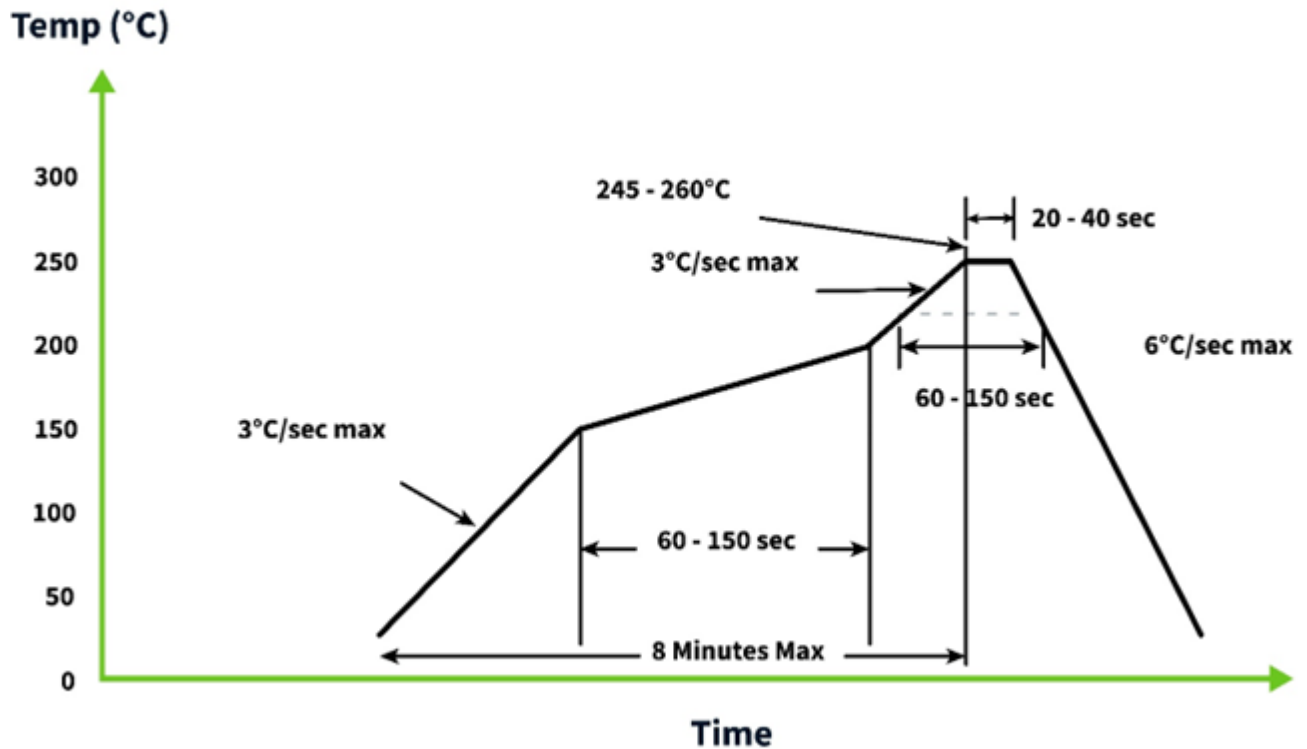

\*Temperatures listed within a tolerance of +/- 10° C

Smaller components are typically mounted on the first pass, however, we do advise mounting the CA.51 when placing larger components on the board during subsequent reflows.

Note: Soldering flux classified ROL0 under IPC J-STD-004 is recommended.

## 8. Packaging

5000 pc CA.51 per reel  
 Dimensions -  $\varnothing 180 \times 11$ mm  
 Weight - 159.8g

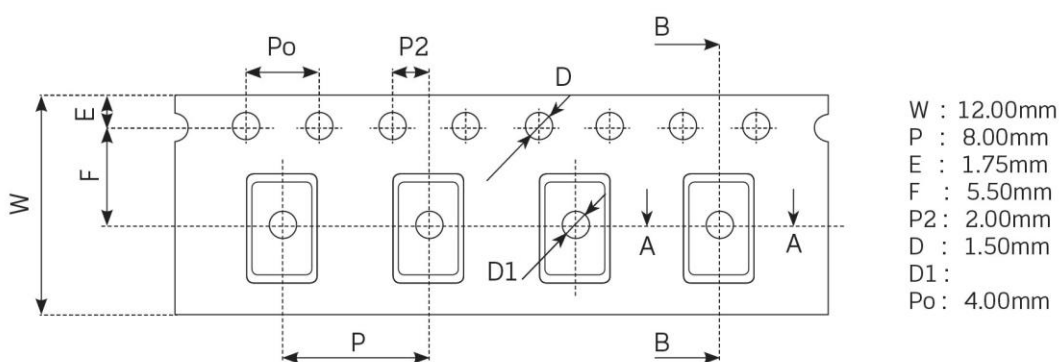
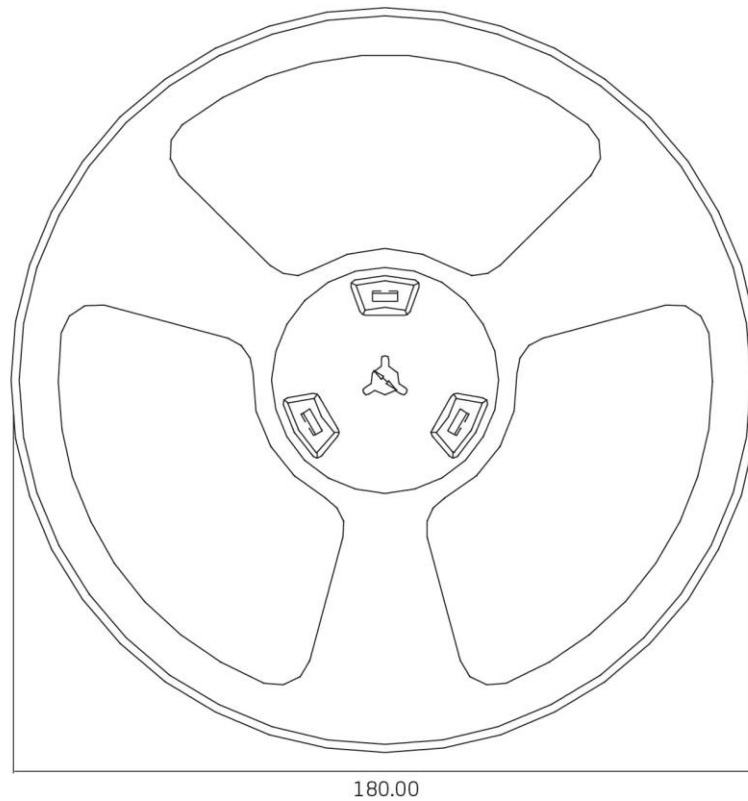

5000 pcs CA.51 reel  
 Dimensions - 180\*180\*11mm  
 Weight - 159.8g

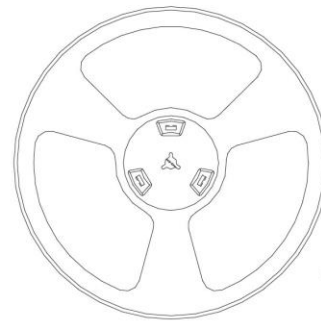

50,000 pcs CA.51 / 10 Reel in small box  
 Dimensions - 193\*225\*195mm  
 Weight - 1.6Kg

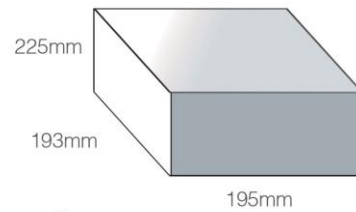

2 small boxes, 100,000 pcs in one carton  
 Carton Dimensions - 247\*405\*225mm  
 Weight - 3.2Kg

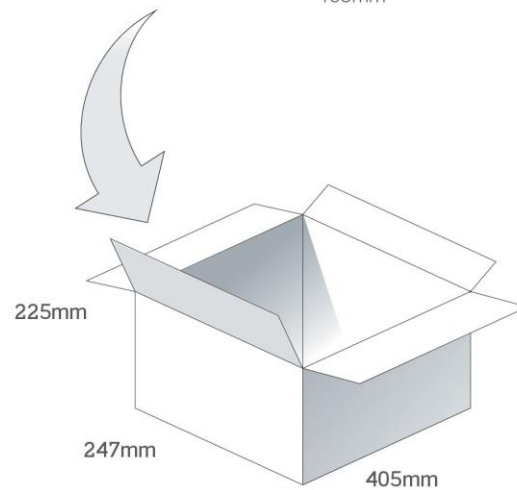

Pallet Dimensions 1200\*1000\*1310mm  
 40 Cartons per Pallet  
 8 Cartons per layer  
 5 Layers

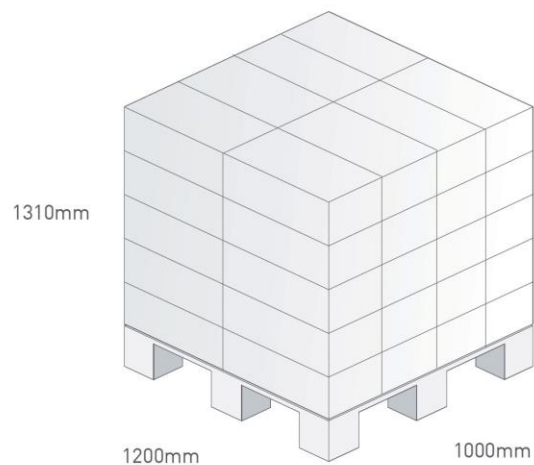

Changelog for the datasheet

**SPE-17-8-032 – CA.51**

**Revision: F (Current Version)**

Date:	2023-10-16
Changes:	Updated specifications
Changes Made by:	Cesar Sousa

**Previous Revisions**

**Revision: E**

Date:	2023-09-14
Changes:	Updated solder reflow information and antenna footprint
Changes Made by:	Cesar Sousa

**Revision: D**

Date:	2023-03-22
Changes:	Integration Guide Added
Changes Made by:	Cesar Sousa

**Revision: C**

Date:	2021-10-04
Changes:	Format Change, MSL
Changes Made by:	Erik Landi

**Revision: B**

Date:	2019-10-25
Changes:	Updated to C-V2X
Changes Made by:	Jack Conroy

**Revision: A (Original First Release)**

Date:	2017-05-22
Notes:	Initial Release
Author:	STAFF



**TAOGLAS**®

[www.taoglas.com](http://www.taoglas.com)

