

**SERIES:** CSXX12B | **DESCRIPTION:** CURRENT SENSOR**FEATURES**

- open loop
- bipolar
- detects current direction
- single channel

**MODEL**

MODEL	rated current (If)	linearity range <sup>1</sup> (Im)
	[A <sub>RMS</sub> ]	[A <sub>PEAK</sub> ]
CS0312B	±3	+9/-3
CS0512B	±5	+15/-5
CS1012B	±10	+30/-10
CS1512B	±15	+45/-15
CS2012B	±20	+60/-20

Notes: 1. Im is the maximum peak current for which the output voltage specifications are guaranteed, however the If RMS rating must not be exceeded.  
 2. All specifications measured at 25°C, RI=10 kΩ, unless otherwise noted.  
 3. It is recommended to add a 1 μF capacitor connected between the common terminal 4 and the +12 V terminal 1 to avoid noise problems.

**SPECIFICATIONS**

parameter	conditions/description	min	typ	max	units
supply voltage (Vcc)		11.4	12.0	12.6	V
max current consumption (Ic)				25	mA
output voltage (Vo)	at +If at -If	4.47 0.47	4.50 0.50	4.53 0.53	V V
zero current offset voltage (Vr)	after demagnetization	2.48	2.50	2.52	V
output voltage linearity <sup>4</sup> (ΔKo)				±0.5	%
response (tr)	at di/dt = If/μs		3		μs
output voltage temperature characteristics				±0.1	%/°C
zero current offset voltage characteristics				±1.5	mV/°C
hysteresis (Vh)	at +If to zero current			8	mV
primary over current	for maximum 50 ms, no damage			10*If	A
withstand voltage	between coil and each terminal for 1 minute		2,000		Vac
insulation resistance	between coil and each terminal at 500 Vdc		500		MΩ
operating temperature		-10		75	°C
storage temperature		-30		90	°C
safety approvals	UL 508				
flammability rating	UL94V-0				
RoHS	yes				

Notes: 4. Deducing the value of hysteresis and offset voltage, calculated by (V/Vo)/(|IfxI-1|)x100%.

## SOLDERABILITY

parameter	conditions/description	min	typ	max	units
hand soldering	for maximum 3 seconds		280		°C

## MECHANICAL

parameter	conditions/description	min	typ	max	units
dimensions	15 x 15 x 20				mm
case material	PBT				
terminals	phosphor bronze with tin plating				
weight			8		g

## MECHANICAL DRAWING

units: mm  
tolerance: ±0.5 mm

PIN CONNECTIONS	
PIN	FUNCTION
1	+12 V
2	NC
3	Output [V]
4	0 V
5	+Input [A]
6	-Input [A]

MODEL NO.	ØA [mm]	ØB [mm]
CS0312B	0.6	1.2
CS0512B	0.9	1.5
CS1012B	1.1	1.7
CS1512B	1.4	2.0
CS2012B	1.7	2.3

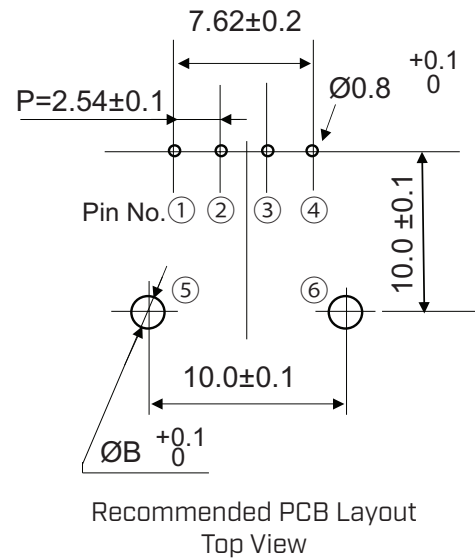
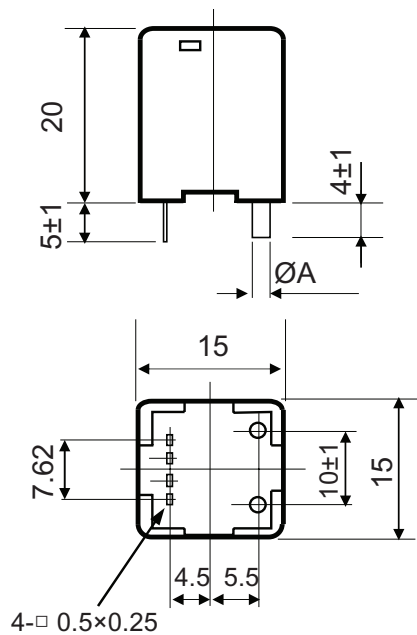

## DERATING CURVE

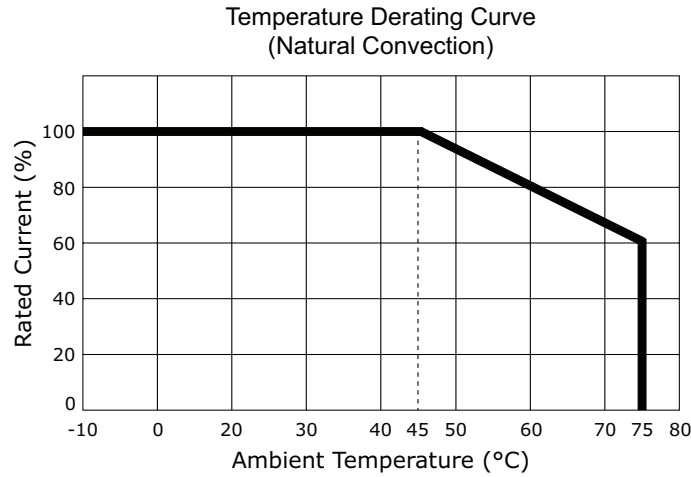

## PERFORMANCE CURVES

Output Voltage vs. Input Current

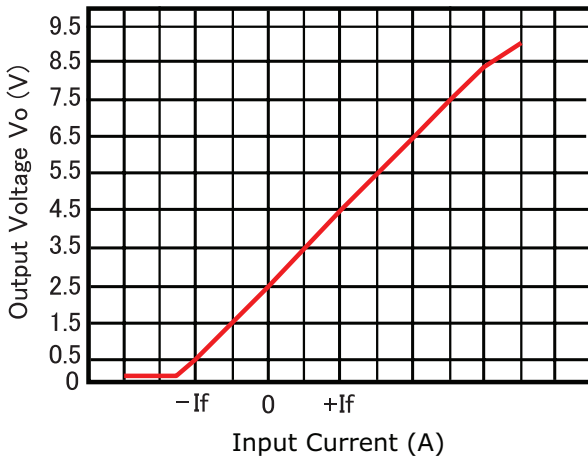

Input Current Frequency vs. Output Attenuation

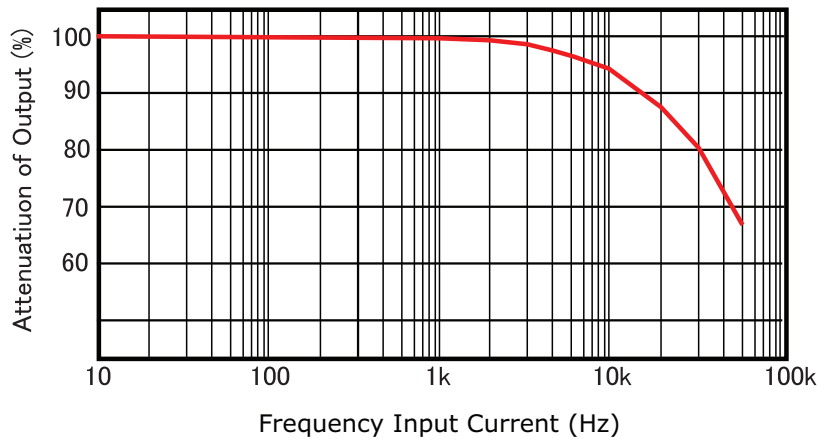

Output Voltage vs. Ambient Temperature  
[at +If]

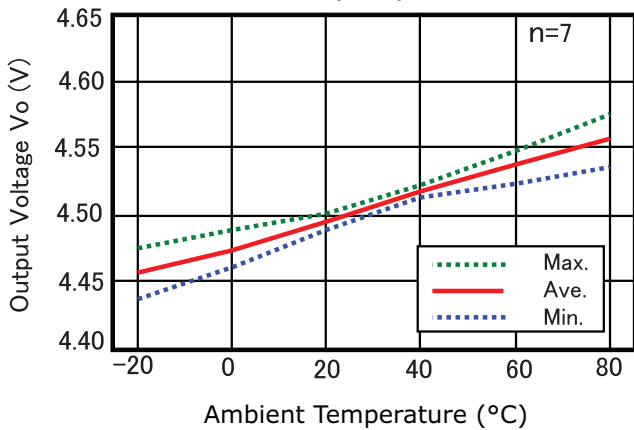

Offset Voltage vs. Ambient Temperature  
[at Zero Current]

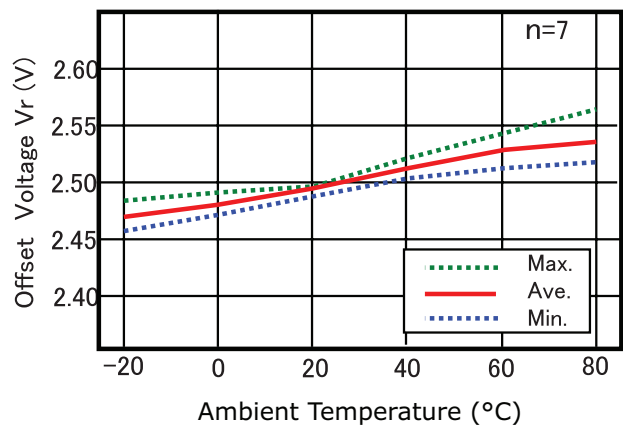

## REVISION HISTORY

rev.	description	date
1.0	initial release	09/03/2019
1.01	brand update	02/21/2020
1.02	logo, datasheet style update	08/05/2022

The revision history provided is for informational purposes only and is believed to be accurate.



CUI Devices offers a one (1) year limited warranty. Complete warranty information is listed on our website.

CUI Devices reserves the right to make changes to the product at any time without notice. Information provided by CUI Devices is believed to be accurate and reliable. However, no responsibility is assumed by CUI Devices for its use, nor for any infringements of patents or other rights of third parties which may result from its use.

CUI Devices products are not authorized or warranted for use as critical components in equipment that requires an extremely high level of reliability. A critical component is any component of a life support device or system whose failure to perform can be reasonably expected to cause the failure of the life support device or system, or to affect its safety or effectiveness.

[cuiddevices.com](http://cuiddevices.com)