



PW Series LTE Band 28

Single-Band Monopole Antenna

PW Series antennas are rugged, low-cost and easy to install. The single frequency band of PW antennas makes the job of antenna selection simple, with better performance in the target frequency band than in multiband antennas and rejection of signals from unwanted frequencies.

The PW LTE Band 28 antenna targets 700 MHz to 810 MHz with excellent VSWR, gain and efficiency for cellular IoT (LTE-M, NB-IoT) applications and traditional LTE, UMTS and GSM needs.

This rugged 1/4-wave monopole antenna may be used with plastic or metal enclosures and supports weather-resistant applications.

FEATURES

- Outperforms similar multiband solutions
- Durable, flexible main shaft
- Wide bandwidth
- Weather resistant for IP-rated applications
- O-ring compatible base
- Compatible with plastic and metal enclosures
- High gain (1.3 dBi at 700 MHz, 1.0 dBi at 750 MHz and 0.7 dBi at 810 MHz)
- High efficiency (59% at 700 MHz, 72% at 750 MHz and 61% at 810 MHz)

APPLICATIONS

- LTE-M (Cat-M1) and NB-IoT
- LTE bands 17, 28 & 44
- GSM-750
- UMTS, USMHC and USMHD
- Sensing and remote monitoring
- Hand-held devices
- Internet of Things (IoT) devices
- Low-power wide-area (LPWA) networks

ORDERING INFORMATION

Part Number	Description
ANT-B28-PW-QW-UFL	LTE Band 28 PW Series antenna, with 216 mm (8.5 in) 1.32 mm coax cable terminated with U.F.L jack (female) connector
ANT-B28-PW-QW	LTE Band 28 PW Series antenna, with 216 mm (8.5 in) unterminated RG-174 coax cable

Available from Linx Technologies and select distributors and representatives.

Notes

1. Use of an O-ring is recommended, IP-ratings cannot be guaranteed
2. With appropriate counterpoise

ELECTRICAL SPECIFICATIONS

ANT-B28-PW-QW-ccc	
Frequency Range	700 MHz to 810 MHz
Center Frequency	750 MHz
VSWR	$\leq 2.7 : 1$
Peak Gain	1.7 dBi
Polarization	Linear
Radiation	Omnidirectional
Max Power	10 W
Wavelength	1/4-wave
Impedance	50 Ω
Connection	U.FL/MHF jack (female) on 1.32 mm cable or unterminated RG-174 cable
Cable Length	216 mm (8.5 in)
Height	98.4 mm (3.87 in)
Weight	ANT-B28-PW-QW = 21.2 g (0.75 oz) ANT-B28-PW-QW-UFL = 19.9 g (0.70 oz)
Operating Temperature	-40 °C to +90 °C

Electrical specifications and plots measured with a 102 mm x 102 mm (4 in x 4 in) reference ground plane.

VSWR

Figure 1 provides the voltage standing wave ratio (VSWR) across the antenna bandwidth. VSWR describes the power reflected from the antenna back to the radio. A lower VSWR value indicates better antenna performance at a given frequency. Reflected power is also shown on the right-side vertical axis as a gauge of the percentage of transmitter power reflected back from the antenna.

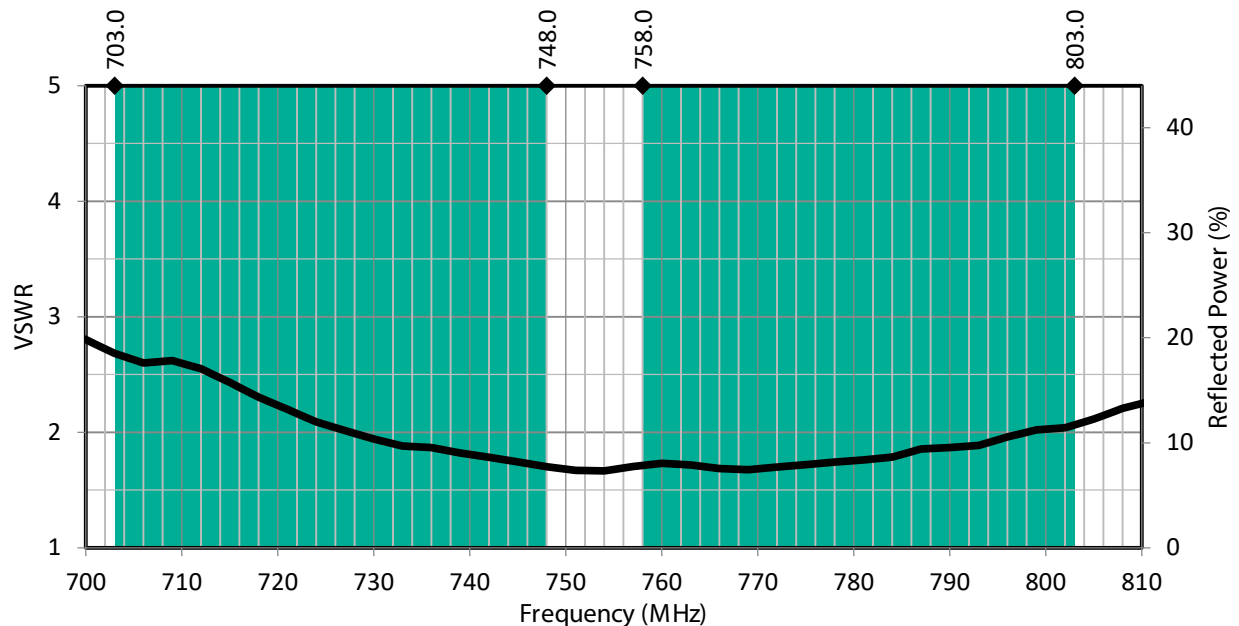

Figure 1: PW LTE Band 28 Antenna VSWR with Band 28 Uplink/Downlink Highlights

RETURN LOSS

Return loss (Figure 2), represents the loss in power at the antenna due to reflected signals. Like VSWR, a lower return loss value indicates better antenna performance at a given frequency.

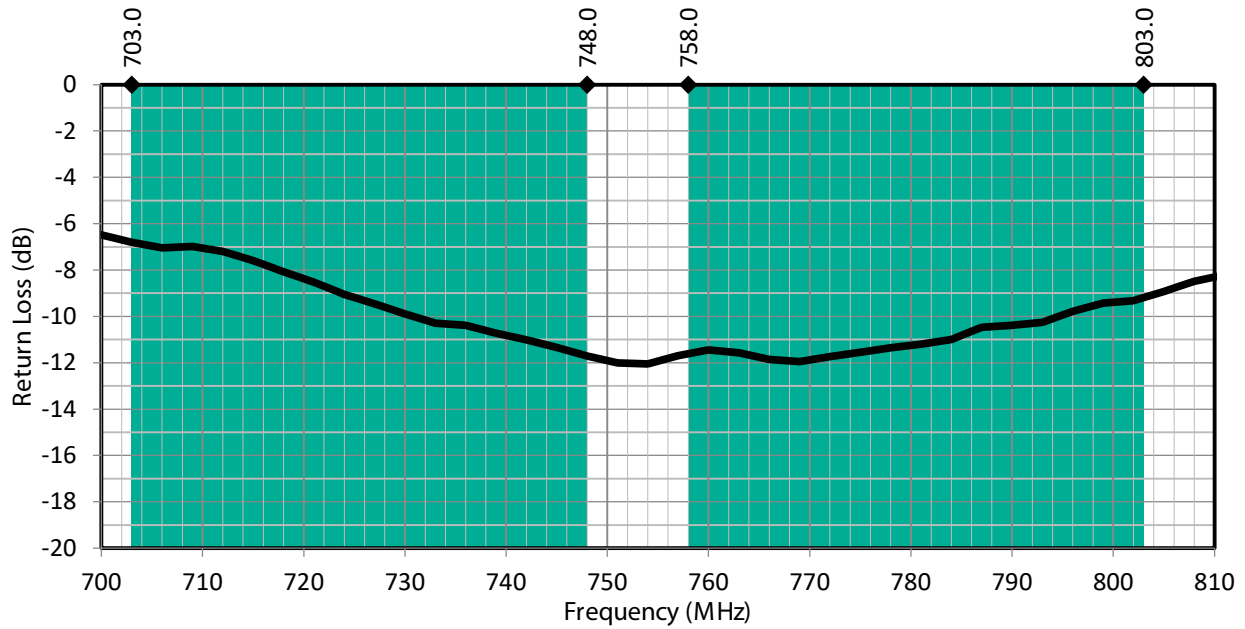

Figure 2: PW LTE Band 28 Antenna Return Loss with Band 28 Uplink/Downlink Highlights

PEAK GAIN

The peak gain across the antenna bandwidth is shown in Figure 3. Peak gain represents the maximum antenna input power concentration across 3-dimensional space, and therefore peak performance, at a given frequency, but does not consider any directionality in the gain pattern.

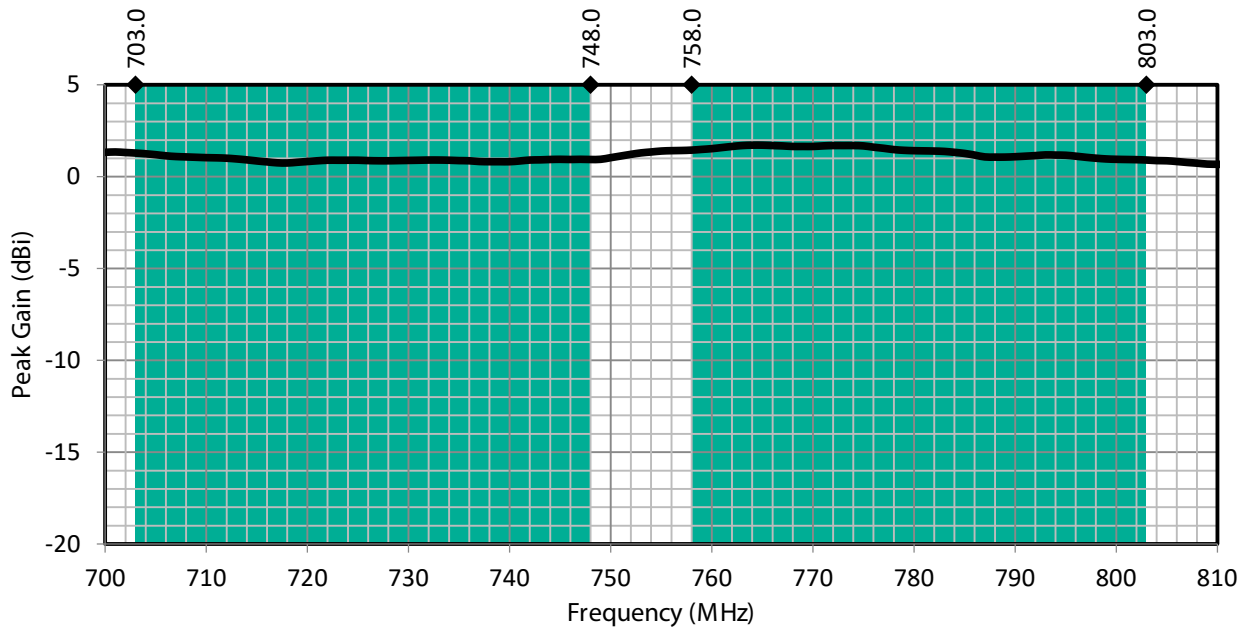

Figure 3: PW LTE Band 28 Antenna Peak Gain with Band 28 Uplink/Downlink Highlights

AVERAGE GAIN

Average gain (Figure 4), is the average of all antenna gain in 3-dimensional space at each frequency, providing an indication of overall performance without expressing antenna directionality.

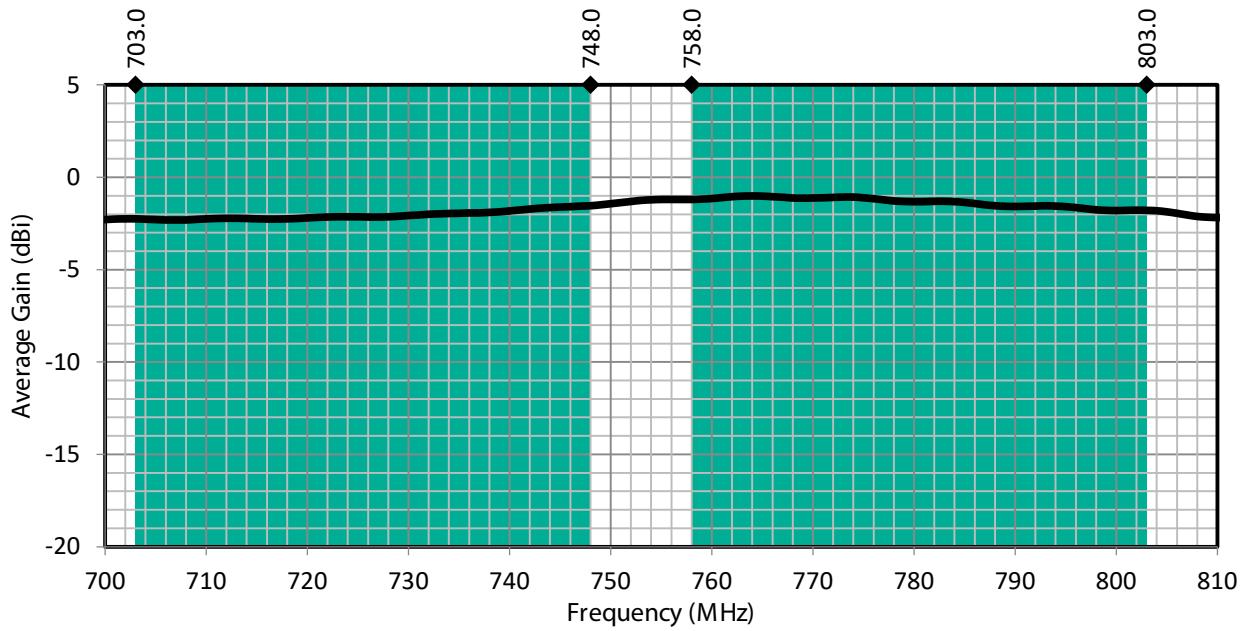

Figure 4: PW LTE Band 28 Antenna Average Gain with Band 28 Uplink/Downlink Highlights

RADIATION EFFICIENCY

Radiation efficiency (Figure 5), shows the ratio of power delivered to the antenna relative to the power radiated at the antenna, expressed as a percentage, where a higher percentage indicates better performance at a given frequency.

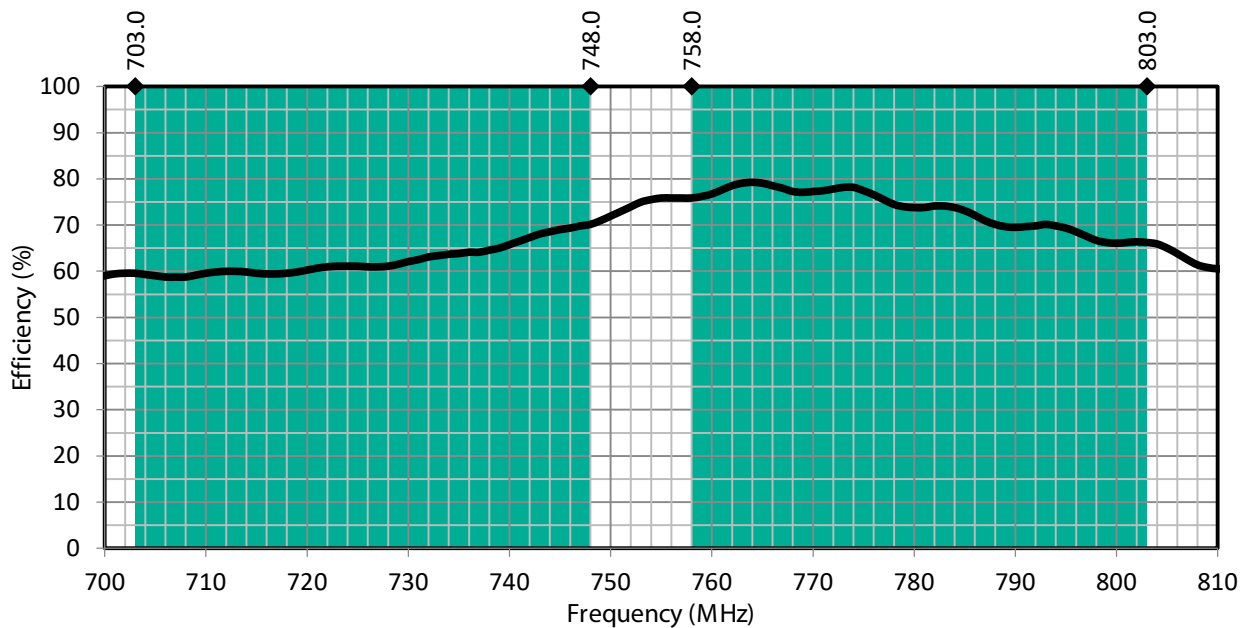

Figure 5: PW LTE Band 28 Antenna Radiation Efficiency with Band 28 Uplink/Downlink Highlights

PRODUCT DIMENSIONS

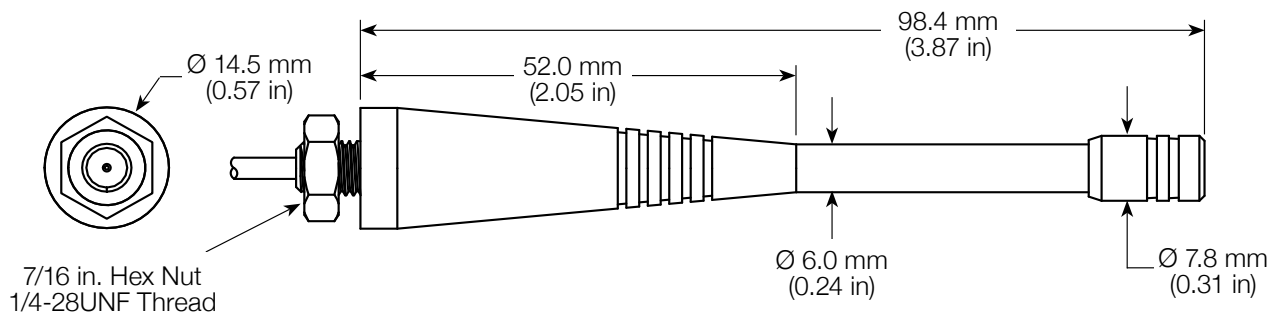

Figure 6: PW LTE Band 28 Antenna Dimensions

ANTENNA MOUNTING

The antenna is attached by placing its cable and base through a 6.35 mm (0.25 in) hole in the product enclosure and securing it with the included nut or by threading it into a PEM-style insert (not included).

The straight-cut RG-174 coax cable option allows the attachment of a 50-ohm RF connector or allows the cable to be soldered directly to a PCB, eliminating the need for a connector. The connectorized option provides a 1.32 mm coax cable terminated with a U.FL/MHF compatible connector for simplified manufacturing or for applications requiring the ability to disconnect the antenna.

COUNTERPOISE

Quarter-wave or monopole antennas require an associated ground plane counterpoise for proper operation. The size and location of the ground plane relative to the antenna will affect the overall performance of the antenna in the final design. When used in conjunction with a ground plane smaller than that used to tune the antenna, the center frequency typically will shift higher in frequency and the bandwidth will decrease. The proximity of other circuit elements and packaging near the antenna will also affect the final performance.

For further discussion and guidance on the importance of the ground plane counterpoise, please refer to Linx Application Note AN-00501: Understanding Antenna Specifications and Operation.

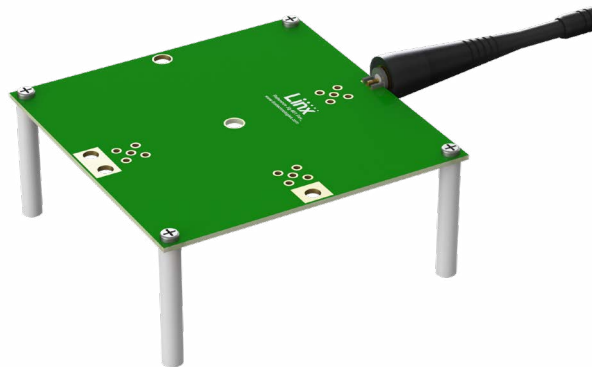

Figure 7: PW LTE Band 28 Antenna Shown On Edge of Evaluation Board

RADIATION PATTERNS

Radiation patterns provide information about the directionality and 3-dimensional gain performance of the antenna by plotting gain at specific frequencies in three orthogonal planes. Antenna radiation patterns (Figure 8), are shown using polar plots covering 360 degrees. The antenna graphic above the plots provides reference to the plane of the column of plots below it. Note: when viewed with typical PDF viewing software, zooming into radiation patterns is possible to reveal fine detail.

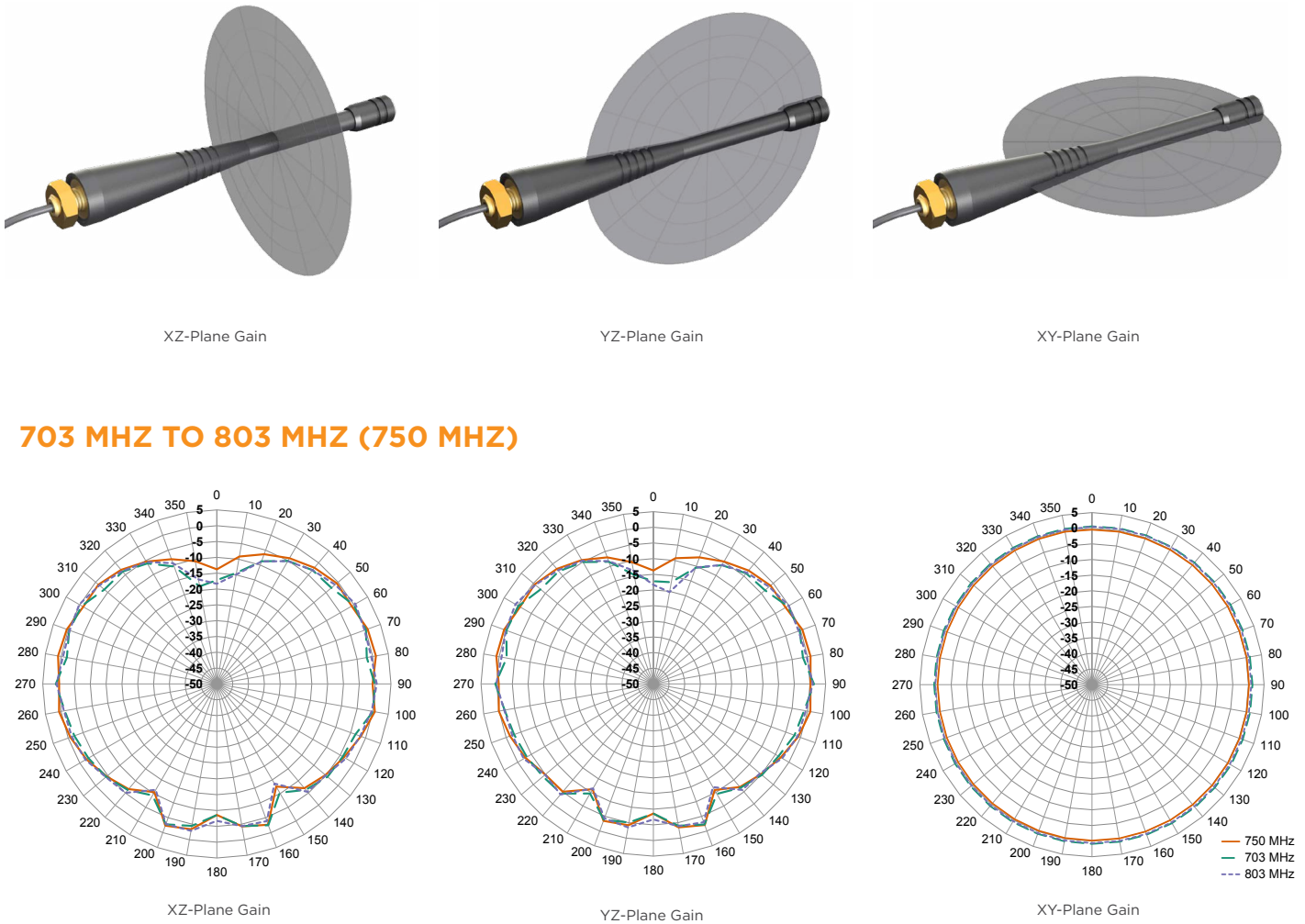

Figure 8: Radiation Patterns for PW LTE Band 28 Antenna

ANTENNA DEFINITIONS AND USEFUL FORMULAS

VSWR - Voltage Standing Wave Ratio. VSWR is a unitless ratio that describes the power reflected from the antenna back to the radio. A lower VSWR value indicates better antenna performance at a given frequency. VSWR is easily derived from Return Loss.

$$\text{VSWR} = \frac{10^{\left[\frac{\text{Return Loss}}{20}\right]} + 1}{10^{\left[\frac{\text{Return Loss}}{20}\right]} - 1}$$

Return Loss - Return loss represents the loss in power at the antenna due to reflected signals, measured in decibels. A lower return loss value indicates better antenna performance at a given frequency. Return Loss is easily derived from VSWR.

$$\text{Return Loss} = -20 \log_{10} \left[\frac{\text{VSWR} - 1}{\text{VSWR} + 1} \right]$$

Efficiency (η) - The total radiated power divided by the input power at the feed point of an antenna.

decibel (dB) - A logarithmic unit of measure of the power of an electrical signal.

decibel isotropic (dBi) - A comparative measure in decibels between an antenna under test and an isotropic radiator.

decibel relative to a dipole (dBd) - A comparative measure in decibels between an antenna under test and an ideal half-wave dipole.

Gain - The ratio of an antenna's efficiency in a given direction (G) to the power produced by a theoretical lossless (100% efficient) isotropic antenna. The gain of an antenna is almost always expressed in decibels.

$$G_{\text{dBi}} = 10 \log_{10}(G)$$

$$G_{\text{dBd}} = G_{\text{dBi}} - 2.15\text{dB}$$

Peak Gain - The highest antenna gain across all directions for a given frequency range. A directional antenna will have a very high peak gain compared to average gain.

Average Gain - The average gain across all directions for a given frequency range.

Maximum Power - The maximum signal power which may be applied to an antenna feed point, typically measured in watts (W).

Omnidirectional - Term describing an antenna radiation pattern that is uniform in all directions (spherical).

An isotropic antenna is the theoretical perfect omnidirectional antenna. An ideal dipole antenna has a donut-shaped radiation pattern and other practical antenna implementations will have less perfect but generally omnidirectional radiation patterns which are typically plotted on three axes.

Dipole - An ideal dipole comprises a straight electrical conductor measuring 1/2 wavelength from end to end connected at the center to a feed point for the radio.

Isotropic Radiator - A theoretical antenna which radiates energy equally in all directions as a perfect sphere.

TE TECHNICAL SUPPORT CENTER

USA:	+1 (800) 522-6752
Canada:	+1 (905) 475-6222
Mexico:	+52 (0) 55-1106-0800
Latin/S. America:	+54 (0) 11-4733-2200
Germany:	+49 (0) 6251-133-1999
UK:	+44 (0) 800-267666
France:	+33 (0) 1-3420-8686
Netherlands:	+31 (0) 73-6246-999
China:	+86 (0) 400-820-6015

te.com

TE Connectivity, TE, TE connectivity (logo), Linx and Linx Technologies are trademarks owned or licensed by the TE Connectivity Ltd. family of companies. All other logos, products and/or company names referred to herein might be trademarks of their respective owners.

The information given herein, including drawings, illustrations and schematics which are intended for illustration purposes only, is believed to be reliable. However, TE Connectivity makes no warranties as to its accuracy or completeness and disclaims any liability in connection with its use. TE Connectivity's obligations shall only be as set forth in TE Connectivity's Standard Terms and Conditions of Sale for this product and in no case will TE Connectivity be liable for any incidental, indirect or consequential damages arising out of the sale, resale, use or misuse of the product. Users of TE Connectivity products should make their own evaluation to determine the suitability of each such product for the specific application.

TE Connectivity warrants to the original end user customer of its products that its products are free from defects in material and workmanship. Subject to conditions and limitations TE Connectivity will, at its option, either repair or replace any part of its products that prove defective because of improper workmanship or materials. This limited warranty is in force for the useful lifetime of the original end product into which the TE Connectivity product is installed. Useful lifetime of the original end product may vary but is not warranted to exceed one (1) year from the original date of the end product purchase.

©2022 TE Connectivity. All Rights Reserved.

11/22 Original