

Series AMEL20-CJZ

20 Watt | AC-DC / DC-DC Converter

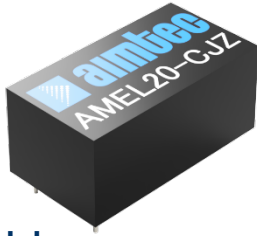

FEATURES:

- I/O Isolation 4000VAC
- Operating Temp: -40°C to +70°C
- Over current, Over Voltage Protection
- Input: 85-264VAC, 47-63Hz, or 100-370VDC
- Continuous Short Circuit Protection
- Up to 83% efficiency
- Low ripple and noise

Models Single output



Model	Input Voltage (VAC/Hz)	Input Voltage (VDC)	Max Output wattage (W)	Output Voltage (V)	Output Current max (A)	Maximum capacitive load (μF)	Efficiency (%)
AMEL20-3.3SCJZ	85-264/47-63	100-370	11.8	3.3	3.6	10,000	74
AMEL20-5SCJZ	85-264/47-63	100-370	18	5	3.6	6,600	78
AMEL20-9SCJZ	85-264/47-63	100-370	20	9	2.2	4,400	79
AMEL20-12SCJZ	85-264/47-63	100-370	20	12	1.66	3,000	82
AMEL20-15SCJZ	85-264/47-63	100-370	20	15	1.33	2,000	83
AMEL20-24SCJZ	85-264/47-63	100-370	20	24	0.833	800	83

*Output power must not exceed the listed values.

Note: Add suffix "-ST" for optional screw terminal bottom plate or "-STD" for optional DIN Rail screw terminal bottom plate. (ex. AMEL20-3.3SCJZ-ST, AMEL20-3.3SCJZ-STD).

All specifications in this datasheet are measured at an ambient temperature of 25°C, humidity<75%, nominal input voltage and at rated output load unless otherwise specified.

Input Specifications

Parameters	Conditions	Typical	Maximum	Units
Current	115VAC	0.37	0.44	A
	230VAC	0.24	0.26	A
Inrush current	115VAC	12		A
	230VAC	36		A
External fuse	slow blow type		3.15A/250V	

Output Specifications

Parameters	Conditions	Typical	Maximum	Units
Voltage accuracy	3.3V output	±3		%
	Others	±2		%
Line regulation	Full load	±0.5		%
Load regulation	0%-100% load	±1		%
Ripple & Noise*	20MHz bandwidth	50	120	mV p-p
Hold up time	115VAC	10		ms
	230VAC	55		ms

* Please refer to the application note for specific details.

Isolation Specifications

Parameters	Conditions	Typical	Rated	Units
Tested I/O voltage	60 sec, ≤5mA		4000	VAC

General Specifications

Parameters	Conditions	Typical	Maximum	Units
Switching frequency		100		KHz
Protection class		Class II		
Over current protection	Auto recovery	≥110		% of Iout
Over voltage protection	3.3V, 5V output		7.5	V
	9V output		15	V
	12V, 15V output		20	V
	24V output		30	V
Short circuit protection		Continuous, hiccup		
Short circuit restart		Auto recovery		

Operating temperature	See derating table	-40 to +70	°C
Storage temperature		-40 to +85	°C
Temperature coefficient		±0.02	% / °C
Power derating	-40 to 0°C	1.67	% / °C
	+40 to +70°C, 3.3/5Vout models	2.66	% / °C
	+40 to +70°C, other models	2.33	% / °C
	85 to 130VAC, -25 to +70°C, 5Vout model	0.66	% / VAC
	85 to 130VAC, -40 to -25°C, 5Vout model	1.33	% / VAC
	85 to 100VAC, -25 to +70°C, other models	2	% / VAC
	85 to 100VAC, -40 to -25°C, other models	4	% / VAC
	240 to 264VAC	0.83	% / VAC
Cooling	Free air convection		
Humidity	Non-condensing	95	% RH
Case material	Black Plastic (flammability to UL 94V-0)		
Weight	PCB mountable models	60	g
	With optional -ST mounting plate	80	
	With optional -STD mounting plate	100	
Dimensions (L x W x H)	PCB mountable models	2.11 x 1.13 x 0.92inches (53.80 x 28.80 x 23.50mm)	
	With optional -ST mounting plate	2.99 x 1.24 x 1.27inches (76.00 x 31.50 x 32.30mm)	
	With optional -STD mounting plate	2.99 x 1.24 x 1.45inches (76.00 x 31.50 x 36.90mm)	
MTBF	> 300 000 hrs (MIL-HDBK -217F, t=+25°C)/Full Load		
Soldering temperature	Wave soldering, duration 5 to 10s	260	°C
	Manual soldering, duration 3 to 5s	360	°C

Safety Specifications

Parameters		
Agency approval	cULus	
Standards	Information technology Equipment	UL60950-1, UL62368-1
	EMI - Conducted and radiated emission	EN55032, class B
	Electrostatic Discharge Immunity	IEC61000-4-2, Contact ±6KV/ Air ±8KV, Criteria B
	RF, Electromagnetic Field Immunity	IEC61000-4-3, 10V/m, Criteria A
	Electrical Fast Transient/Burst Immunity	IEC61000-4-4, ±4KV, Criteria B
	Surge Immunity	IEC61000-4-5, L-L ±2KV, Criteria B
		IEC61000-4-5, L-L ±4KV/ L-G ±6KV, Criteria B (With the recommended circuit)
	RF, Conducted Disturbance Immunity	IEC61000-4-6, 10Vrms, Criteria A
Voltage dips, Short Interruptions Immunity	IEC61000-4-11, 0% 70%, Criteria B	

Pin Out Specifications

Pin	Single
1	AC Input (N)
2	AC Input (L)
3	+V Output
4	-V Output

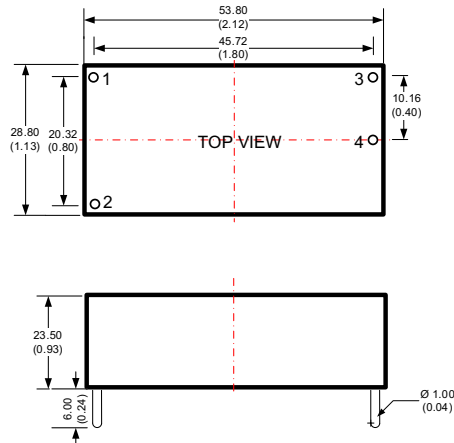

Dimensions

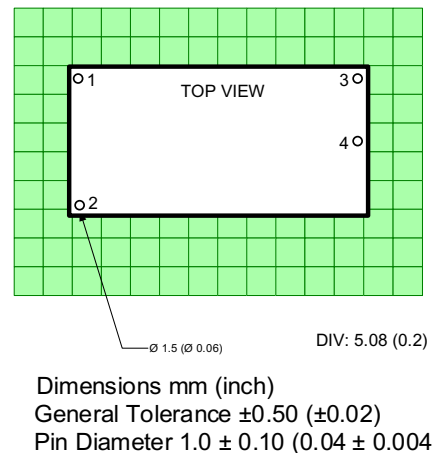

With optional -ST bottom plate

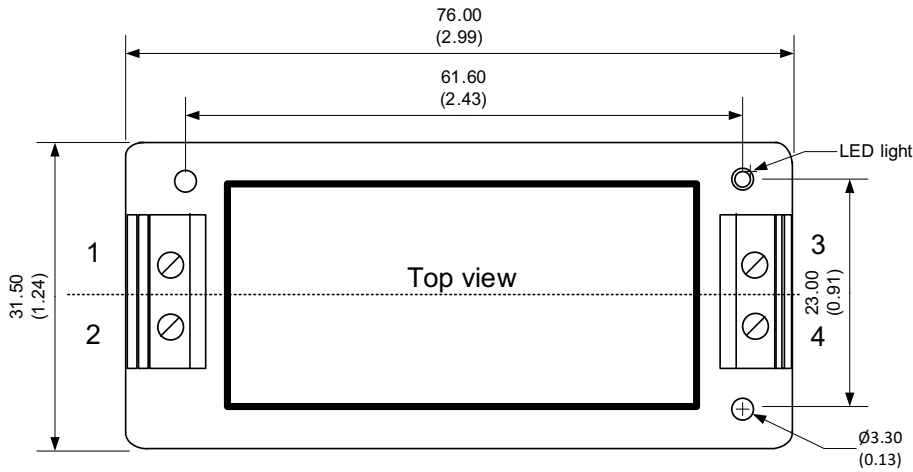

Pin Out Specifications

Pin	Single
1	AC Input (N)
2	AC Input (L)
3	+V Output
4	-V Output

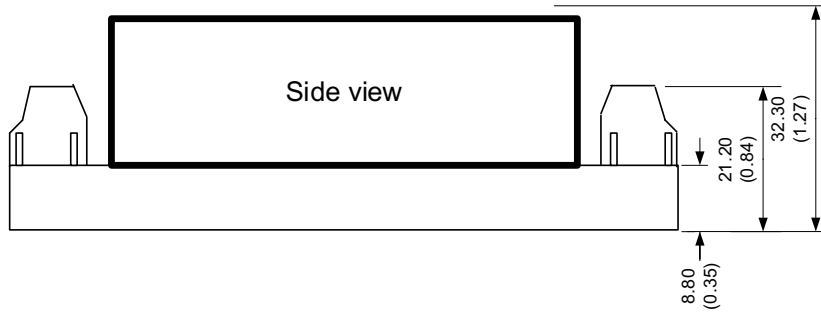

Dimensions: mm (inch)
General tolerance: ± 1.00 (0.04)
Wire gauge: 24-12AWG
Tightening torque: 0.4N-m

With optional -STD bottom plate

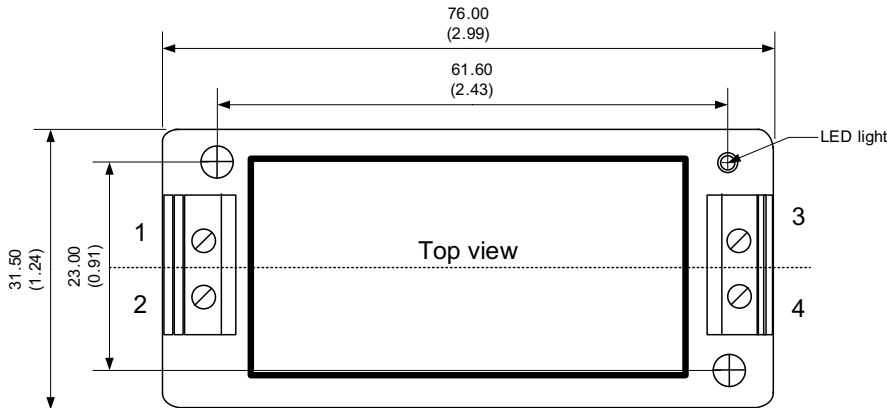

Pin Out Specifications

Pin	Single
1	AC Input (N)
2	AC Input (L)
3	+V Output
4	-V Output

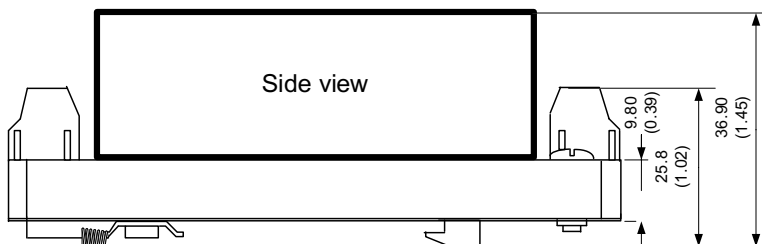

Dimensions: mm (inch)
General tolerance: ± 1.00 (0.04)
Wire gauge: 24-12AWG
Tightening torque: 0.4N-m
Rail type: TS35

Derating for AMEL20-5SCJZ

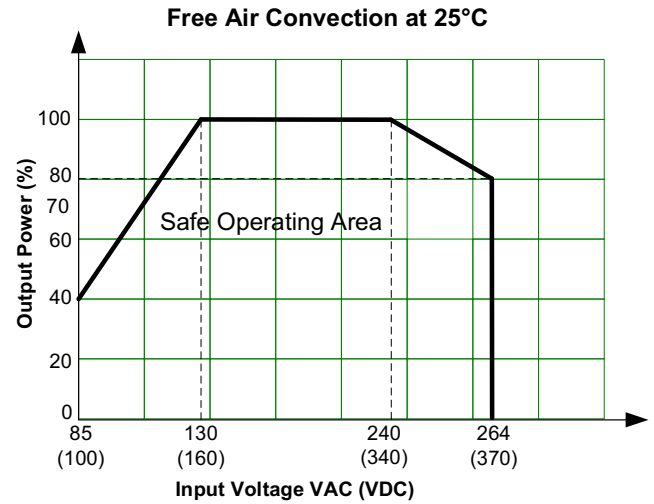
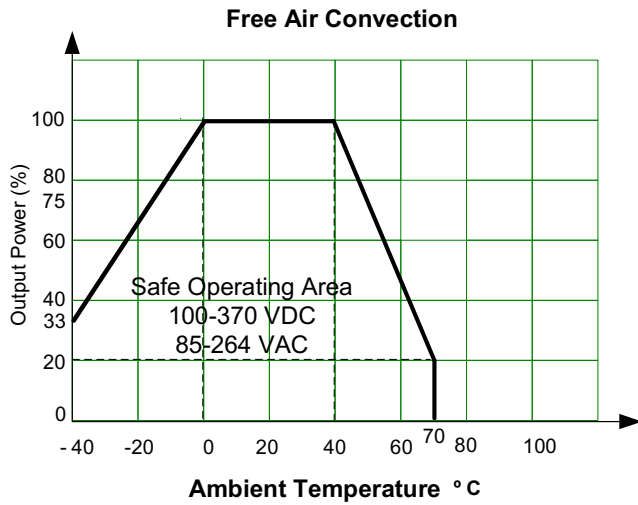

Derating for all other part numbers

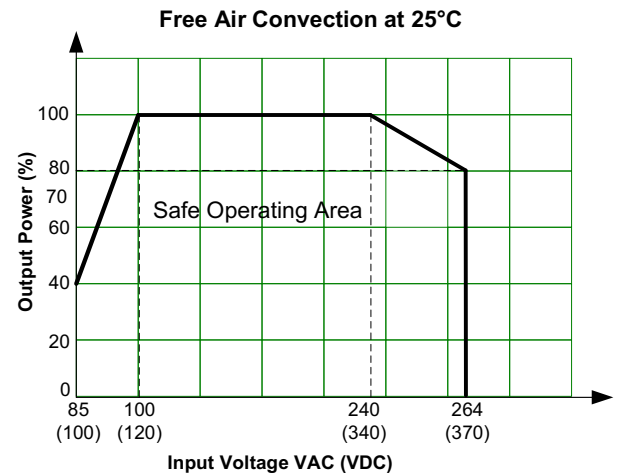
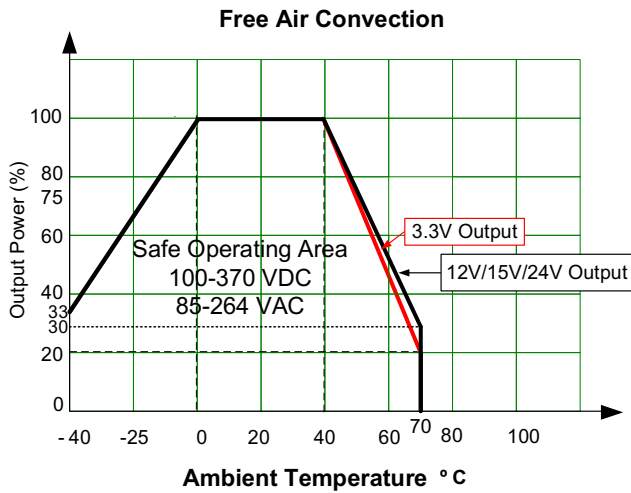

Typical application circuit

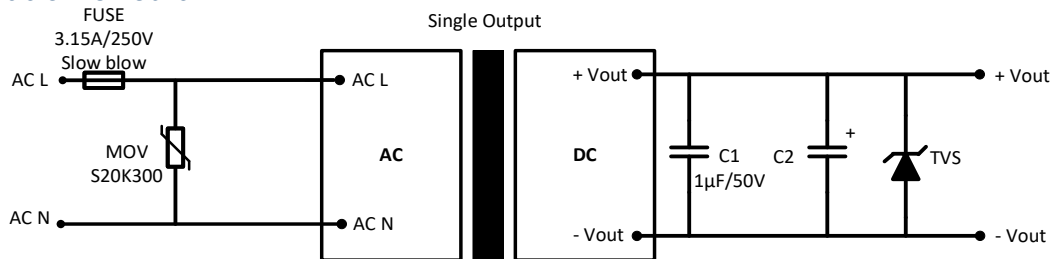

Model	C2	C2 (For high frequency switch type load)	TVS
3.3 & 5 Vout	220 µF / 16V	470 µF / 16V (Solid capacitor)	7V
9 Vout	120 µF / 25V	470 µF / 16V (Solid capacitor)	12V
12 & 15 Vout	120 µF / 25V	390µF / 25V	20V
24 Vout	68 µF / 35V	220µF / 35V	30V

For filtering components:

Choose capacitors with at least 20% voltage margin. The C2 capacitor is recommended to use electrolytic type with high frequency and low ESR rating. The C1 capacitor is recommended to use ceramic type for filtering high-frequency noise.

To meet surge Immunity $\pm 4\text{KV}/\pm 6\text{KV}$ recommended circuit

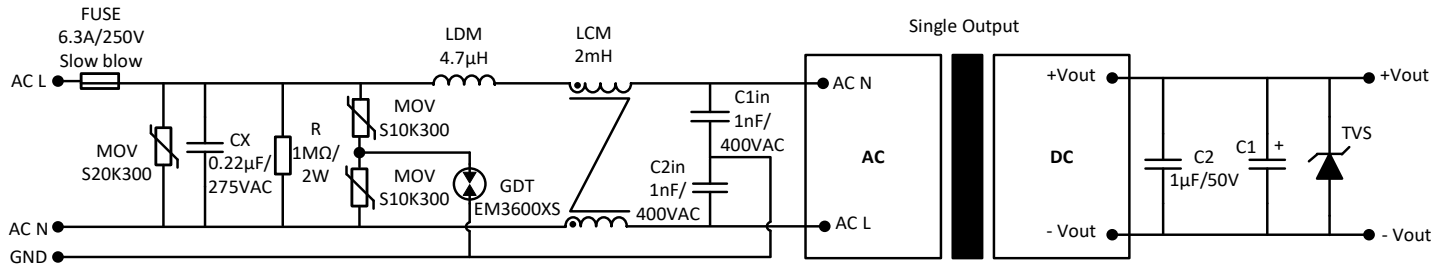

NOTE: 1. Datasheets are updated as needed and as such, specifications are subject to change without notice. Once printed or downloaded, datasheets are no longer controlled by Aimtec; refer to www.aimtec.com for the most current product specifications. 2. Product labels shown, including safety agency certifications on labels, may vary based on the date manufactured. 3. Mechanical drawings and specifications are for reference only. 4. All specifications are measured at an ambient temperature of 25°C, humidity < 75%, nominal input voltage and at rated output load unless otherwise specified. 5. Aimtec may not have conducted destructive testing or chemical analysis on all internal components and chemicals at the time of publishing this document. CAS numbers and other limited information are considered proprietary and may not be available for release. 6. This product is not designed for use in critical life support systems, equipment used in hazardous environments, nuclear control systems or other such applications which necessitate specific safety and regulatory standards other than the ones listed in this datasheet. 7. Warranty is in accordance with Aimtec's standard Terms of Sale available at www.aimtec.com.