

ASMM-Cx04-xxxx2

PLCC-2 Surface-Mount LED with Black Surface

Description

The Broadcom[®] family of Surface-Mount LED is packaged in the industry-standard PLCC-2 package and has high reliability performance designed to work under a wide range of environmental conditions. This high reliability feature makes it ideally suited to be used in various signage applications. This surface-mount (SMT) LED comes with a black top surface to minimize reflection from ambient light and improve contrast.

To facilitate easy pick and place assembly, the LEDs are packed in tape and reel form. Every reel is shipped in single flux and color bin, to provide close uniformity.

Features

- Industry-standard PLCC-2 package.
- High-reliability package with enhanced silicone resin encapsulation.
- High brightness using AlInGaP dice technology.
- Available in Amber and Red colors.
- Black surface for enhanced contrast.
- Wide viewing angle at 120°.
- JEDEC MSL 3.

Applications

- Variable message signs.
- Passenger information signs.
- Bus information signs.

CAUTION! This LED is ESD sensitive. Please observe appropriate precautions during handling and processing. Refer to application note AN-1142 for additional details.

Figure 1: Package Drawing

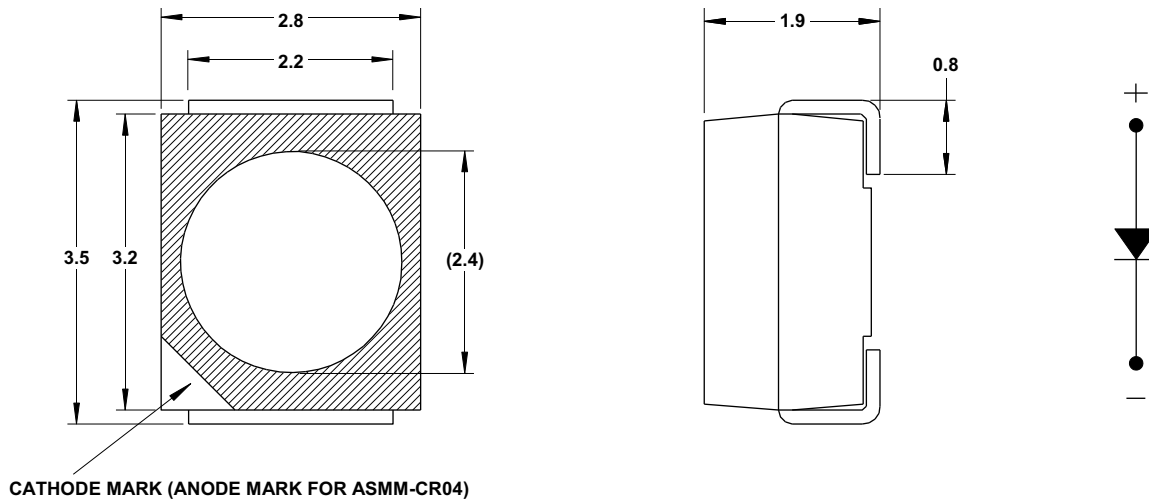
**NOTE:**

1. Dimensions in bracket are for reference only.
2. Tolerance is ± 0.20 mm unless otherwise specified.
3. Encapsulation = silicone.
4. Terminal finish = silver plating.
5. All dimensions in millimeters (mm).

Absolute Maximum Ratings

Parameter	ASMM-Cx04-xxxx2	Unit
DC Forward Current ^a	30	mA
Peak Forward Current ^b	50	mA
Power Dissipation	78	mW
LED Junction Temperature	110	°C
Operating Temperature Range	-40 to +100	°C
Storage Temperature Range	-40 to +100	°C

a. Derate linearly as shown in [Figure 10](#), [Figure 11](#), [Figure 12](#), and [Figure 13](#).

b. Duty factor = 10%, frequency = 1 kHz.

Optical Characteristics (T_J = 25°C, I_F = 20 mA)

Part Number	Color	Package	Luminous Intensity, I _V (mcd) ^{a, b}			Peak Wavelength, λ _p (nm) Typ.	Dominant Wavelength, λ _d (nm) ^c Typ.	Viewing Angle, 2θ _{1/2} (°) ^d Typ.
			Min.	Typ.	Max.			
ASMM-CA04-CV2C2	Amber	Non-diffused	715	—	1125	592	590	120
ASMM-CA04-CV6C2	Amber	Diffused	900	—	1400	592	590	120
ASMM-CA04-CV6J2	Amber	Diffused	900	—	1400	592	590	120
ASMM-CR04-BV602	Red	Non-diffused	900	—	1400	630	625	120

a. The luminous intensity, I_V is measured at the mechanical axis of the LED package at a single current pulse condition. The actual peak of the spatial radiation pattern might not be aligned with the axis.

b. Luminous intensity tolerance = ±12%.

c. The dominant wavelength, λ_d, is derived from the CIE Chromaticity Diagram and represents the color of the device.

d. θ_{1/2} is the off-axis angle where the luminous intensity is half of the peak intensity.

Electrical Characteristics (T_J = 25°C)

Part Number	Color	Package	Forward Voltage, V _F (V) ^a			Reverse Voltage, V _R (V) at I _R = 100 μA ^b	Thermal Resistance, R _{θJ-S} (°C/W) ^c
			Min.	Typ.	Max.		
ASMM-CA04-CV2C2	Amber	Non-diffused	1.7	2.4	2.6	5	250
ASMM-CA04-CV6C2	Amber	Diffused	1.7	2.4	2.6	5	250
ASMM-CA04-CV6J2	Amber	Diffused	1.7	2.4	2.6	5	250
ASMM-CR04-BV602	Red	Non-diffused	1.7	2.2	2.6	5	100

a. Forward voltage, V_F tolerance: ±0.1V.

b. Indicates product final test condition only. Long-term reverse bias is not recommended.

c. Thermal resistance from LED junction to solder point.

Part Numbering System

A S M M - C x₁ 0 4 - x₂ x₃ x₄ x₅ x₆

Code	Description	Option	
x ₁	Color	A	Amber
		R	Red
x ₂	Dice Technology	B	AllnGaP
		C	AllnGaP
x ₃	Minimum Intensity Bin	Refer to Intensity Bin Limits (CAT)	
x ₄	Number of Half Bins	2	2 half bins starting from (x ₃)1
		6	2 half bins starting from (x ₃)2
x ₅	Color Bin Option	0	Full distribution
		C	3 and 4 only
		J	3, 4, and 5 only
x ₆	Test Option	2	Test current = 20 mA

Part Number Example

ASMM-CA04-CV6C2

- x₁: A — Amber color
- x₃, x₄: V 6 — 2 half bins from intensity bin V2 (V2 and W1)
- x₅: C — Color bins 3 and 4 only
- x₆: 2 — Test current = 20 mA

Bin Information

Intensity Bin Limits (CAT)

Bin ID	Luminous Intensity, I _v (mcd)	
	Min.	Max.
V1	715	900
V2	900	1125
W1	1125	1400

Tolerance = ±12%.

Example of bin information on reel and packaging label:

- CAT: V2 — Intensity bin V2
- BIN: 4 — Color bin 4

Color Bin Limits (BIN)

Bin ID	Dominant Wavelength, λ _d (nm)	
	Min.	Max.
Amber		
3	586.0	589.0
4	589.0	592.0
5	592.0	595.0
Red		
—	618.0	635.0

Tolerance = ±1.0 nm.

Figure 2: Spectral Power Distribution

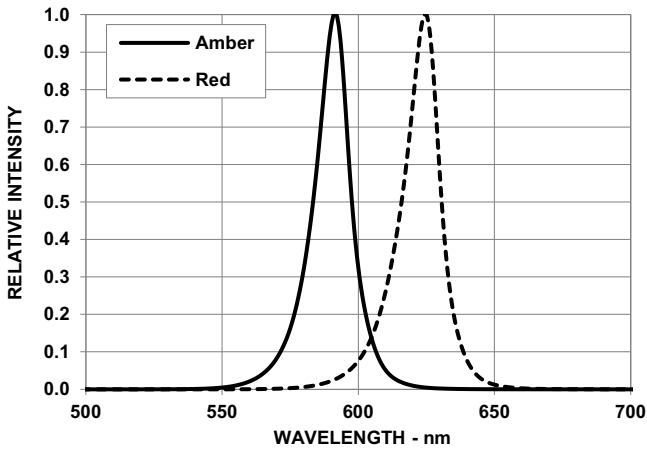

Figure 3: Forward Current vs. Forward Voltage

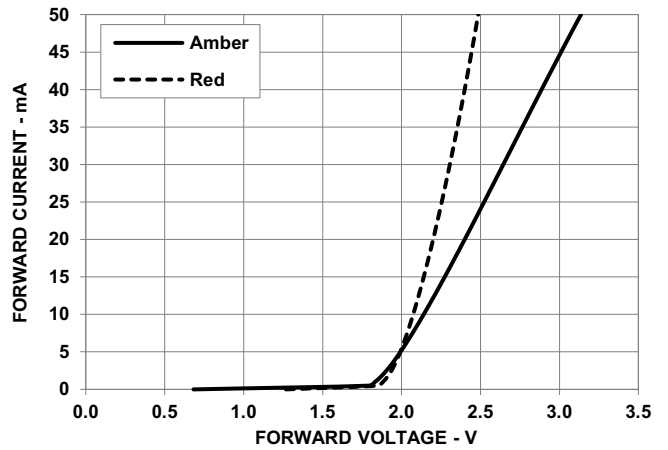

Figure 4: Relative Luminous Intensity vs. Mono Pulse Current

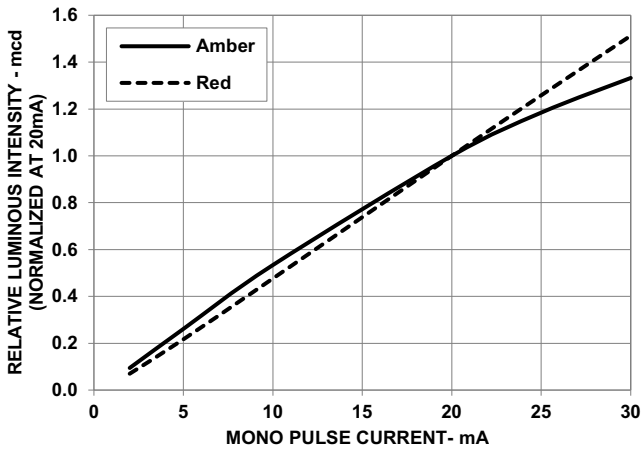

Figure 5: Radiation Pattern

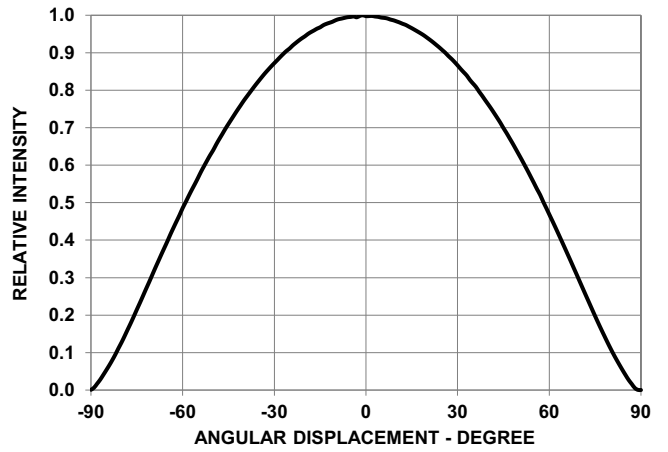

Figure 6: Dominant Wavelength Shift vs. Mono Pulse Current

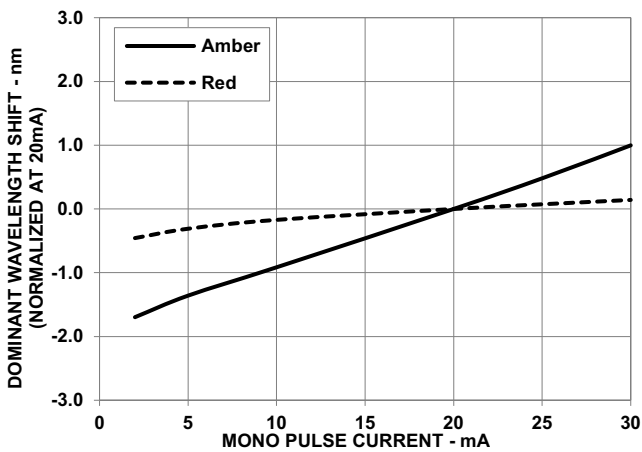

Figure 7: Relative Light Output vs. Junction Temperature

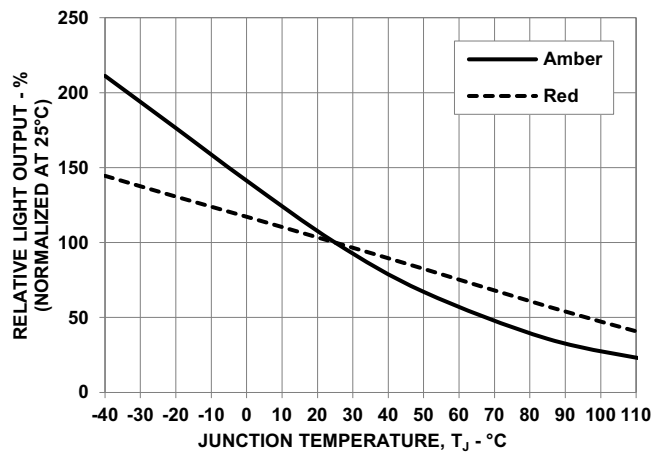

Figure 8: Forward Voltage Shift vs. Junction Temperature

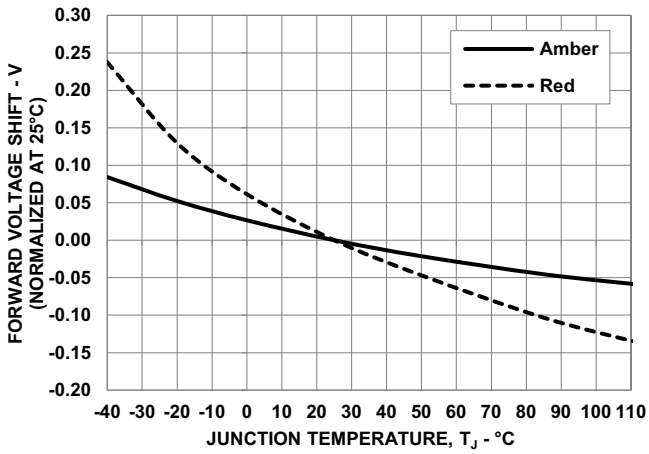

Figure 9: Dominant Wavelength Shift vs. Junction Temperature

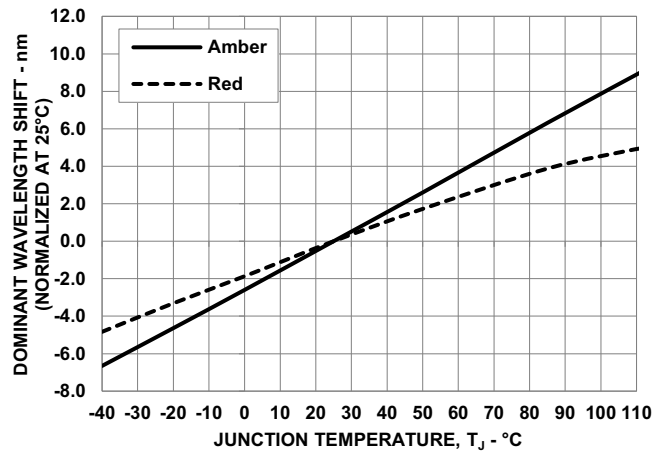

Figure 10: Maximum Forward Current vs. Ambient Temperature - Amber

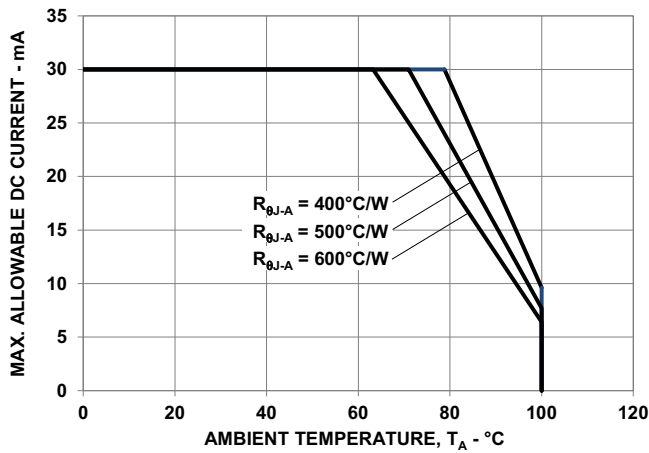

Figure 11: Maximum Forward Current vs. Solder Point Temperature - Amber

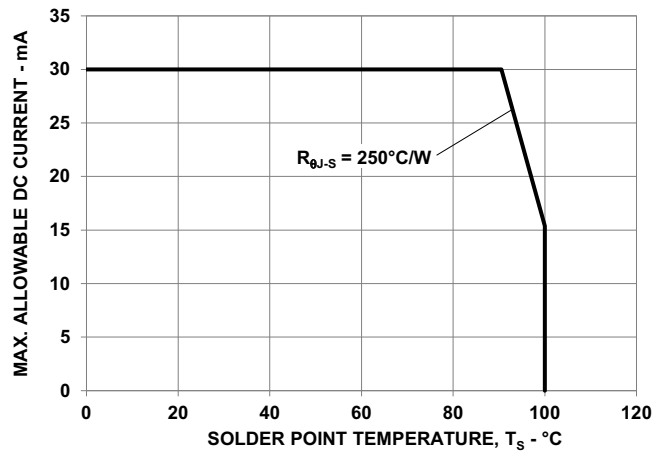

Figure 12: Maximum Forward Current vs. Ambient Temperature - Red

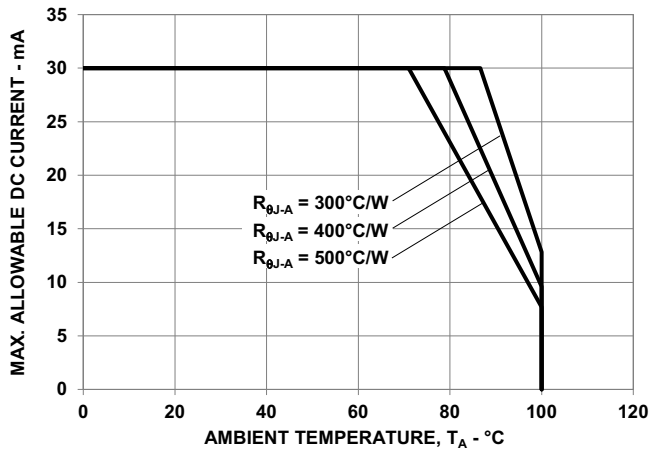

Figure 13: Maximum Forward Current vs. Solder Point Temperature - Red

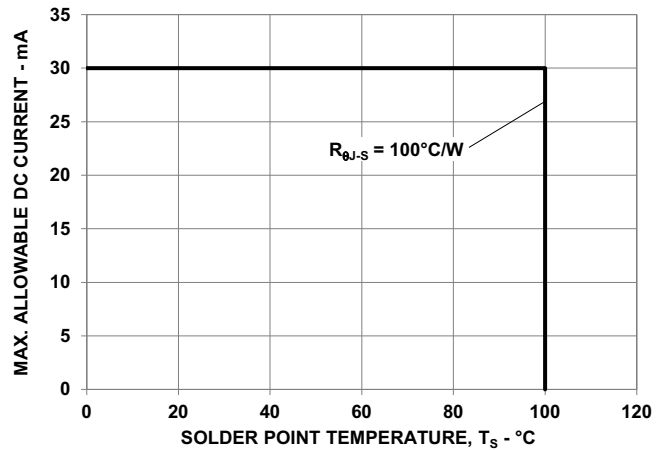
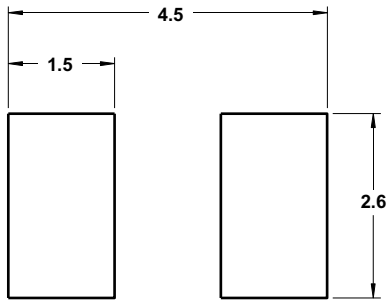
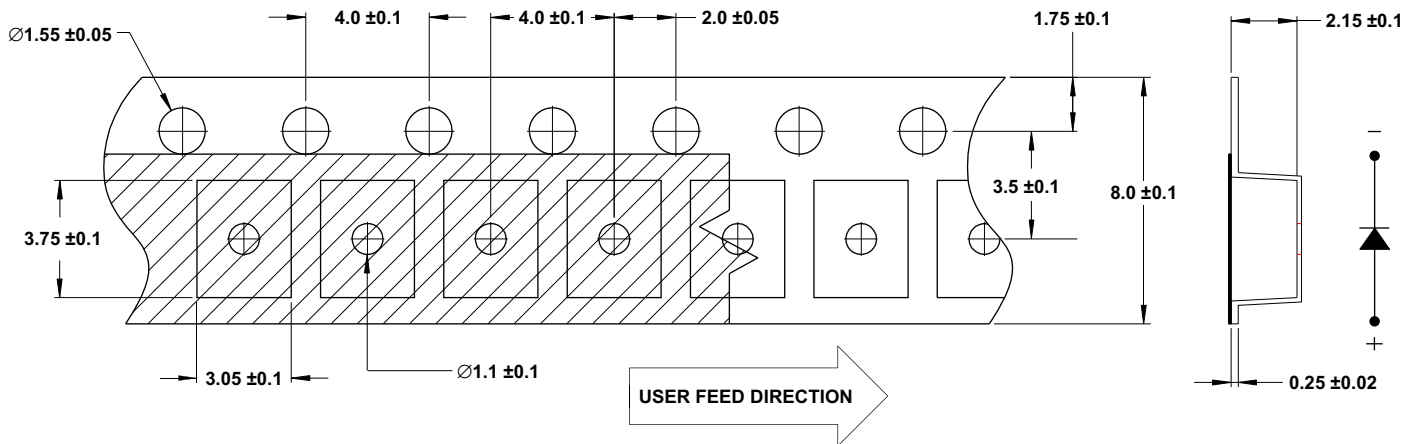

Figure 14: Recommended Soldering Land Pattern



NOTE: All dimensions are in millimeters (mm).

Figure 15: Carrier Tape Dimensions



NOTE: All dimensions are in millimeters (mm).

Figure 16: Reel Dimensions

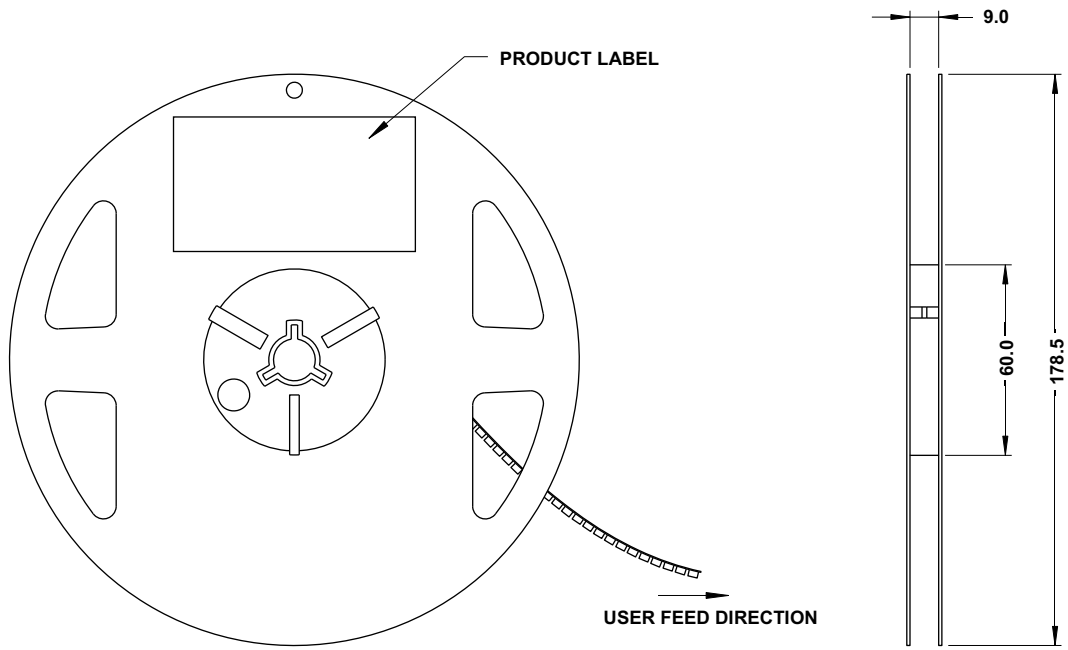

NOTE: All dimensions are in millimeters (mm).

Precautionary Notes

Soldering

- Do not perform reflow soldering more than twice. Observe necessary precautions of handling moisture-sensitive device as stated in the following section.
- Do not apply any pressure or force on the LED during reflow and after reflow when the LED is still hot.
- Use reflow soldering to solder the LED. Use hand soldering only for rework if unavoidable, but it must be strictly controlled to following conditions:
 - Soldering iron tip temperature = 315°C max.
 - Soldering duration = 3 second max.
 - Number of cycles = 1 only.
 - Power of soldering iron = 50W max.
- Do not touch the LED package body with the soldering iron except for the soldering terminals, as it may cause damage to the LED.
- Confirm beforehand whether the functionality and performance of the LED is affected by soldering with hand soldering.

Figure 17: Recommended Lead-Free Reflow Soldering Profile

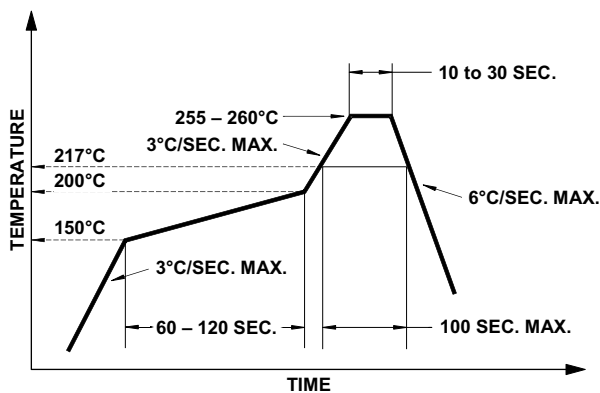
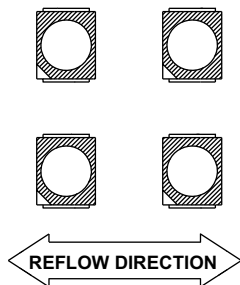

Figure 18: Recommended Board Reflow Direction



Handling Precautions

The encapsulation material of the LED is made of silicone for better product reliability. Compared to epoxy encapsulant, which is hard and brittle, silicone is softer and flexible. Observe special handling precautions during assembly of silicone encapsulated LED products. Failure to comply might lead to damage and premature failure of the LED. Refer to Broadcom Application Note AN5288, *Silicone Encapsulation for LED: Advantages and Handling Precautions*, for additional information.

- Do not poke sharp objects into the silicone encapsulant. Sharp objects, such as tweezers or syringes, might apply excessive force or even pierce through the silicone and induce failures to the LED die or wire bond.
- Do not touch the silicone encapsulant. Uncontrolled force acting on the silicone encapsulant might result in excessive stress on the wire bond. Hold the LED only by the body.
- Do not stack assembled PCBs together. Use an appropriate rack to hold the PCBs.
- Surface of silicone material attracts dust and dirt easier than epoxy due to its surface tackiness. To remove foreign particles on the surface of silicone, use a cotton bud with isopropyl alcohol (IPA). During cleaning, rub the surface gently without putting too much pressure on the silicone. Ultrasonic cleaning is not recommended.
- For automated pick and place, Broadcom has tested a nozzle size with OD 3.5 mm to work with this LED. However, due to the possibility of variations in other parameters such as pick and place machine maker/model, and other settings of the machine, verify that the selected nozzle will not cause damage to the LED.

Handling of Moisture-Sensitive Device

This product has a Moisture Sensitive Level 3 rating per JEDEC J-STD-020. Refer to Broadcom Application Note AN5305, *Handling of Moisture Sensitive Surface Mount Devices*, for additional details and a review of proper handling procedures.

- Before use:
 - An unopened moisture barrier bag (MBB) can be stored at <40°C/90% RH for 12 months. If the actual shelf life has exceeded 12 months and the Humidity

Indicator Card (HIC) indicates that baking is not required, then it is safe to reflow the LEDs per the original MSL rating.

- Do not open the MBB prior to assembly (for example, for IQC). If unavoidable, MBB must be properly resealed with fresh desiccant and HIC. The exposed duration must be taken in as floor life.
- Control after opening the MBB:
 - Read the HIC immediately upon opening of MBB.
 - Keep the LEDs at <30°/60% RH at all times, and complete all high temperature-related processes, including soldering, curing, or rework, within 168 hours.
- Control for unfinished reel:

Store unused LEDs in a sealed MBB with desiccant or a desiccator at <5% RH.
- Control of assembled boards:

If the PCB soldered with the LEDs is to be subjected to other high-temperature processes, store the PCB in a sealed MBB with desiccant or desiccator at <5% RH to ensure that all LEDs have not exceeded their floor life of 168 hours.
- Baking is required if:
 - The HIC indicator indicates a change in color for 10% and 5%, as stated on the HIC.
 - The LEDs are exposed to conditions of >30°C/60% RH at any time.
 - The LED's floor life exceeded 168 hours.

The recommended baking condition is 60°C ± 5°C for 20 hours.

Baking can only be done once.

- Storage:

The soldering terminals of these Broadcom LEDs are silver plated. If the LEDs are exposed in ambient environment for too long, the silver plating might be oxidized, thus affecting its solderability performance. As such, keep unused LEDs in a sealed MBB with desiccant or in a desiccator at <5% RH.

Application Precautions

- The drive current of the LED must not exceed the maximum allowable limit across temperature as stated in the data sheet. Constant current driving is recommended to ensure consistent performance.
- Circuit design must cater to the whole range of forward voltage (V_F) of the LEDs to ensure the intended drive current can always be achieved.

- The LED exhibits slightly different characteristics at different drive currents, which can result in a larger variation of performance (meaning: intensity, wavelength, and forward voltage). Set the application current as close as possible to the test current to minimize these variations.
- Do not use the LED in the vicinity of material with sulfur content or in environments of high gaseous sulfur compounds and corrosive elements. Examples of material that might contain sulfur are rubber gaskets, room-temperature vulcanizing (RTV) silicone rubber, rubber gloves, and so on. Prolonged exposure to such environments can affect the optical characteristics and product life.
- Avoid rapid change in ambient temperature, especially in high-humidity environments, because they cause condensation on the LED.
- If the LED is intended to be used in harsh or outdoor environment, protect the LED against damages caused by rain water, water, dust, oil, corrosive gases, external mechanical stresses, and so on.

Thermal Management

The optical, electrical, and reliability characteristics of the LED are affected by temperature. Keep the junction temperature (T_J) of the LED below the allowable limit at all times. T_J can be calculated as follows:

$$T_J = T_A + R_{\theta_{J-A}} \times I_F \times V_{Fmax}$$

where:

T_A = ambient temperature (°C).

$R_{\theta_{J-A}}$ = thermal resistance from LED junction to ambient (°C/W).

I_F = forward current (A).

V_{Fmax} = maximum forward voltage (V).

The complication of using this formula lies in T_A and $R_{\theta_{J-A}}$. Actual T_A is sometimes subjective and hard to determine. $R_{\theta_{J-A}}$ varies from system to system depending on design and is usually not known.

Another way of calculating T_J is by using the solder point temperature, T_S as follows:

$$T_J = T_S + R_{\theta_{J-S}} \times I_F \times V_{Fmax}$$

where:

T_S = LED solder point temperature as shown in [Figure 19](#) (°C).

$R_{\theta_{J-S}}$ = thermal resistance from junction to solder point ($^{\circ}\text{C}/\text{W}$).

I_F = forward current (A).

V_{Fmax} = maximum forward voltage (V).

Figure 19: Solder Point Temperature on PCB

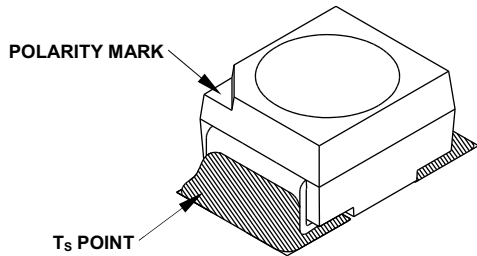

T_S can be easily measured by mounting a thermocouple on the soldering joint as shown in [Figure 19](#), while $R_{\theta_{J-S}}$ is provided in this data sheet. Verify the T_S of the LED in the final product to ensure that the LEDs are operating within all maximum ratings stated in this data sheet.

Eye Safety Precautions

LEDs can pose optical hazards when in operation. Do not look directly at operating LEDs because it might be harmful to the eyes. For safety reasons, use appropriate shielding or personal protective equipment.

Disclaimer

Broadcom's products and software are not specifically designed, manufactured, or authorized for sale as parts, components, or assemblies for the planning, construction, maintenance, or direct operation of a nuclear facility or for use in medical devices or applications. The customer is solely responsible, and waives all rights to make claims against Broadcom or its suppliers, for all loss, damage, expense, or liability in connection with such use.

Copyright © 2021-2022 Broadcom. All Rights Reserved. The term "Broadcom" refers to Broadcom Inc. and/or its subsidiaries. For more information, go to www.broadcom.com. All trademarks, trade names, service marks, and logos referenced herein belong to their respective companies.

Broadcom reserves the right to make changes without further notice to any products or data herein to improve reliability, function, or design. Information furnished by Broadcom is believed to be accurate and reliable. However, Broadcom does not assume any liability arising out of the application or use of this information, nor the application or use of any product or circuit described herein, neither does it convey any license under its patent rights nor the rights of others.



Lead (Pb) Free
RoHS Compliant