



ANT-5GW-MMG1-SMA SERIES

Magnetic Mount 5G Cellular Antennas

The ANT-5GW-MMG1-SMA antenna is an external magnetic mount multiband antenna designed for 5G New Radio, LTE, and cellular IoT (LTE-M, NB-IoT) applications.

The ANT-5GW-MMG1-SMA series antennas provide a ground plane independent dipole antenna solution which mounts to ferrous metallic surfaces using the integrated magnetic base.

The antenna terminates in an SMA plug (male pin) connector on a 1 meter, 2 meter or 3 meter length of RG-174/U coaxial cable.

FEATURES

- Performance at 698 MHz to 803 MHz
 - VSWR: ≤ 2.3
 - Peak Gain: 2.5 dBi
 - Efficiency: 80%
- Performance at 3300 MHz to 4200 MHz
 - VSWR: ≤ 2.1
 - Peak Gain: 3.5 dBi
 - Efficiency: 28%
- Ground plane independent dipole antenna
- Compact, only 82.8 mm (3.26 in) tall
- Integrated magnetic base securely attaches to ferrous metallic surfaces and allows for repositioning
- SMA plug (male pin) connection

APPLICATIONS

- Worldwide 5G/4G/3G/2G
- Cellular IoT: LTE-M (Cat-M1) and NB-IoT
- Private cellular networks
 - Citizens Broadband Radio Service (CBRS)
- 4.9 GHz Public Safety
- Emerging 5G C-Band applications
- Emerging 5G 2.5 GHz EBS applications
- Remote control, monitoring and sensing
- Internet of Things (IoT) devices
- ISM applications

ORDERING INFORMATION

Part Number	Description
ANT-5GW-MMG1-SMA-1	Magnetic mount 5G/LTE antenna with an SMA plug (male pin) connector on 1 m (39.37 in) RG-174/U coaxial cable
ANT-5GW-MMG1-SMA-2	Magnetic mount 5G/LTE antenna with an SMA plug (male pin) connector on 2 m (78.74 in) RG-174/U coaxial cable
ANT-5GW-MMG1-SMA-3	Magnetic mount 5G/LTE antenna with an SMA plug (male pin) connector on 3 m (118.11 in) RG-174/U coaxial cable

Available from Linx Technologies and select distributors and representatives.

TABLE 1. ELECTRICAL SPECIFICATIONS

Bands	Frequency Range	VSWR (max.)	Peak Gain (dBi)	Avg. Gain (dBi)	Efficiency (%)
71	617 MHz to 698 MHz	3.6	-0.4	-4.4	45
12, 13, 14, 17, 28, 29, 44, 67, 68, 85, n83	698 MHz to 803 MHz	2.3	2.5	-1.2	80
5, 18, 19, 20, 26, 27, n82, n89	791 MHz to 894 MHz	2.0	2.5	-1.4	78
8, 11, 21, 32, 45, 50, 51, 74, 75, 76, n81, n91, n92, n93, n94	832 MHz to 1518 MHz	2.9	2.5	-3.0	61
24	1525 MHz to 1661 MHz	3.1	-1.5	-5.8	29
1, 2, 3, 4, 9, 10, 25, 33, 34, 35, 36, 37, 39, 65, 66, 70, n80, n84, n86, n95	1695 MHz to 2200 MHz	2.7	2.1	-4.4	43
7, 30, 38, 40, 41, 53, 69, n90	2300 MHz to 2690 MHz	2.2	1.7	-5.0	36
22, 42, 43, 48, 49, 52, n77, n78	3300 MHz to 4200 MHz	2.1	3.5	-6.2	28

Electrical specifications and plots measured on a 300 mm x 300 mm (11.8 in x 11.8 in) ground plane.

TABLE 2. MECHANICAL SPECIFICATIONS

Parameter	Value
Polarization	Linear
Radiation	Omnidirectional
Max Power	10W
Wavelength	1/2-wave
Electrical Type	Dipole
Impedance	50 Ω
Operating Temp. Range	-20 °C to +80 °C
Storage Temp. Range	-20 °C to +80 °C
Dimensions	82.8 mm x Ø30.0 mm (3.26 in x Ø1.18 in)

Part Number	Connection	Coaxial Cable, minimum inside bend radius	Weight
Polarization	SMA plug (male pin)	RG-174/U: 10.2 mm (0.40 in),	1 meter = 30.1 g (1.06 oz)
Radiation	SMA plug (male pin)	RG-174/U: 10.2 mm (0.40 in),	2 meters = 43.4 g (1.53 oz)
Max Power	SMA plug (male pin)	RG-174/U: 10.2 mm (0.40 in),	3 meters = 56.8 g (2.00 oz)

PACKAGING INFORMATION

The ANT-5GW-MMG1-SMA series antenna is individually sealed in a polyethylene bag 3.9 in x 7.1 in (100 mm x 180 mm) and packaged in larger bags in of 50 pcs 14.2 in x 20.5 in (360 mm x 520 mm). Bags are packed in cartons in quantities of 400 pcs. Distribution channels may offer alternative packaging options.

ANTENNA MOUNTING

The ANT-5GW-MMG1-SMA series antenna has an integrated magnetic base which mounts securely to ferrous metallic surfaces. The antenna should be mounted in a location that is not obstructed by other metallic surfaces which could interfere with signal transmission and reception. The magnetic base allows for the antenna to be repositioned as needed.

PRODUCT DIMENSIONS

Figure 1 provides dimensions of the ANT-5GW-MMG1-SMA series antenna.

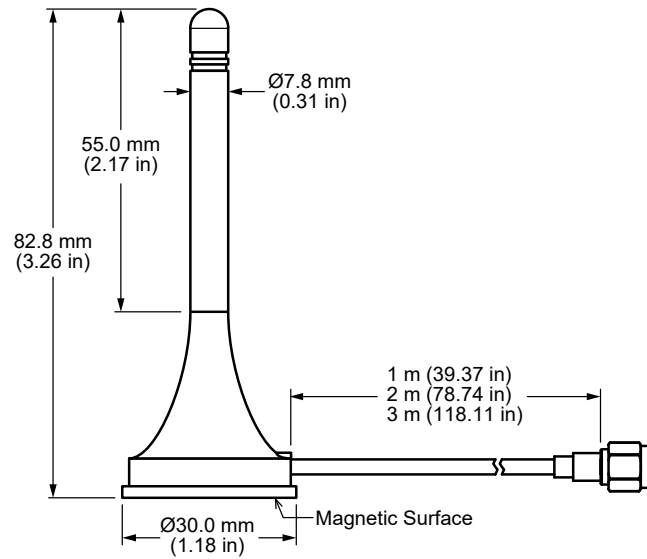

Figure 1. ANT-5GW-MMG1-SMA Series Antenna Dimensions

ANTENNA ORIENTATION

The ANT-5GW-MMG1-SMA antenna is characterized in two antenna orientations as shown in Figure 2. The antenna free space orientation characterizes use of an antenna attached to an enclosure-mounted connector which is connected by cable to a printed circuit board. Although the antenna is a dipole not requiring a ground plane for function, characterization on an adjacent ground plane (300 mm x 300 mm) provides insight into antenna performance when attached directly to a connector on a metal enclosure. The two orientations represent the most common end-product use cases.



Figure 2. ANT-5GW-MMG1-SMA Test Orientations

ON GROUND PLANE

The charts on the following pages represent data taken with the antenna oriented at the center of the 300 mm x 300 mm ground plane as shown in Figure 3.



Figure 3. ANT-5GW-MMG1-SMA on Ground Plane

VSWR

Figure 4 provides the voltage standing wave ratio (VSWR) across the antenna bandwidth. VSWR describes the power reflected from the antenna back to the radio. A lower VSWR value indicates better antenna performance at a given frequency. Reflected power is also shown on the right-side vertical axis as a gauge of the percentage of transmitter power reflected back from the antenna.

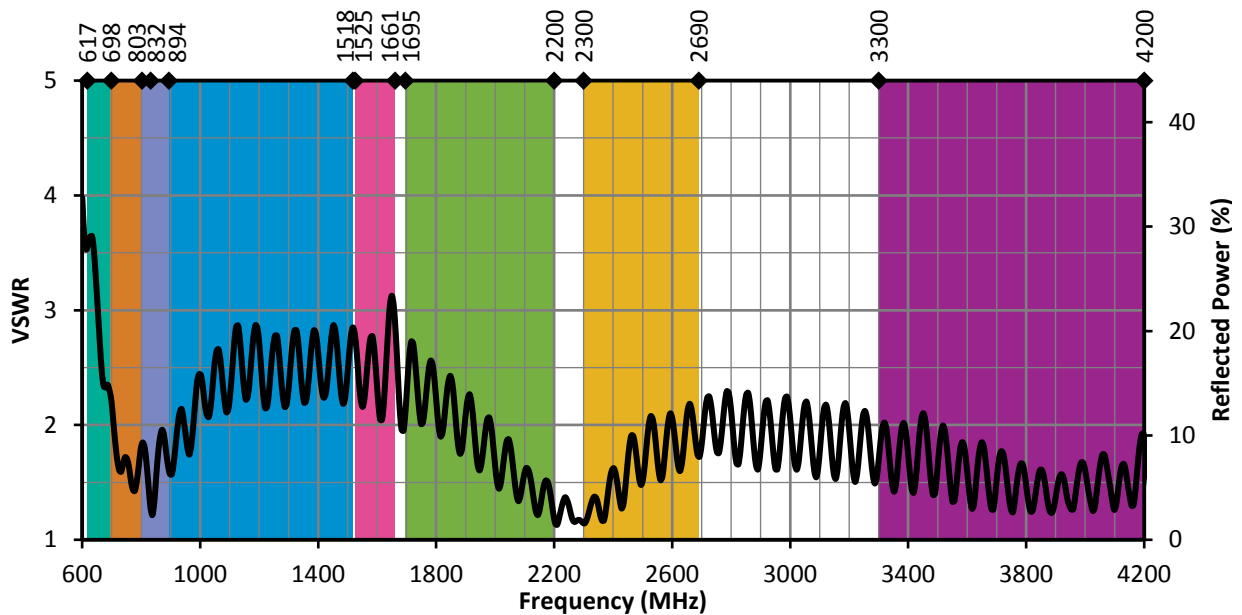

Figure 4. ANT-5GW-MMG1-SMA VSWR on Ground Plane

RETURN LOSS

Return loss (Figure 5), represents the loss in power at the antenna due to reflected signals. Like VSWR, a lower return loss value indicates better antenna performance at a given frequency.

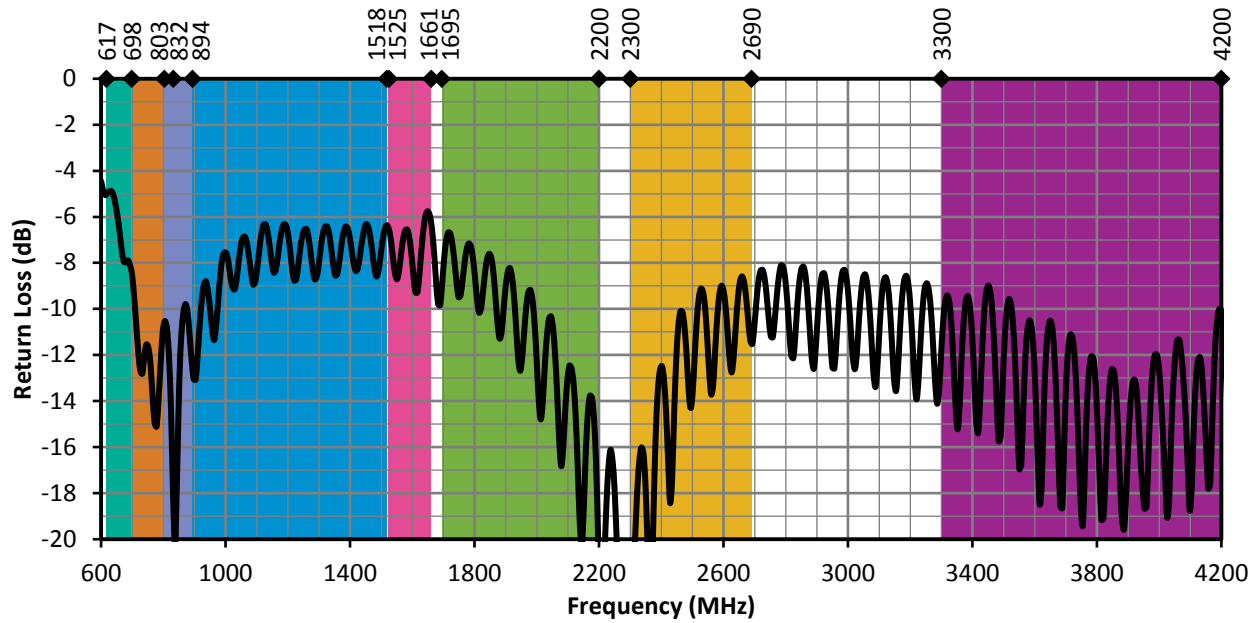

Figure 5. ANT-5GW-MMG1-SMA Return Loss on Ground Plane

PEAK GAIN

The peak gain across the antenna bandwidth is shown in Figure 6. Peak gain represents the maximum antenna input power concentration across 3-dimensional space, and therefore peak performance at a given frequency, but does not consider any directionality in the gain pattern.

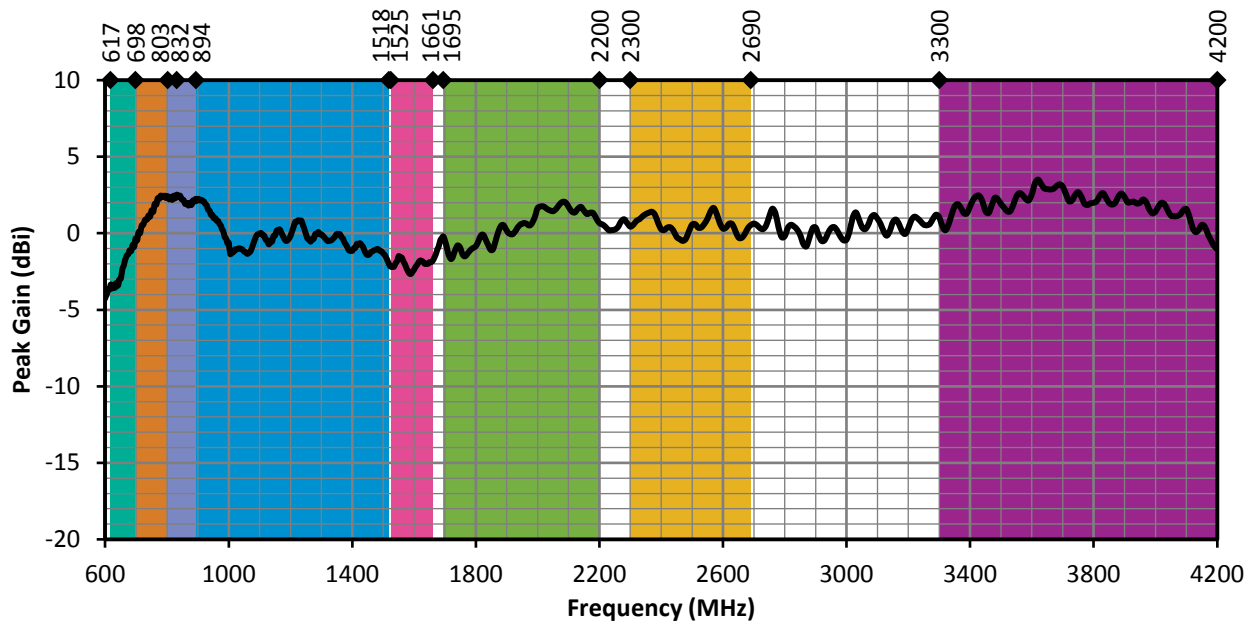

Figure 6. ANT-5GW-MMG1-SMA Peak Gain on Ground Plane

AVERAGE GAIN

Average gain (Figure 7), is the average of all antenna gain in 3-dimensional space at each frequency, providing an indication of overall performance without expressing antenna directionality.

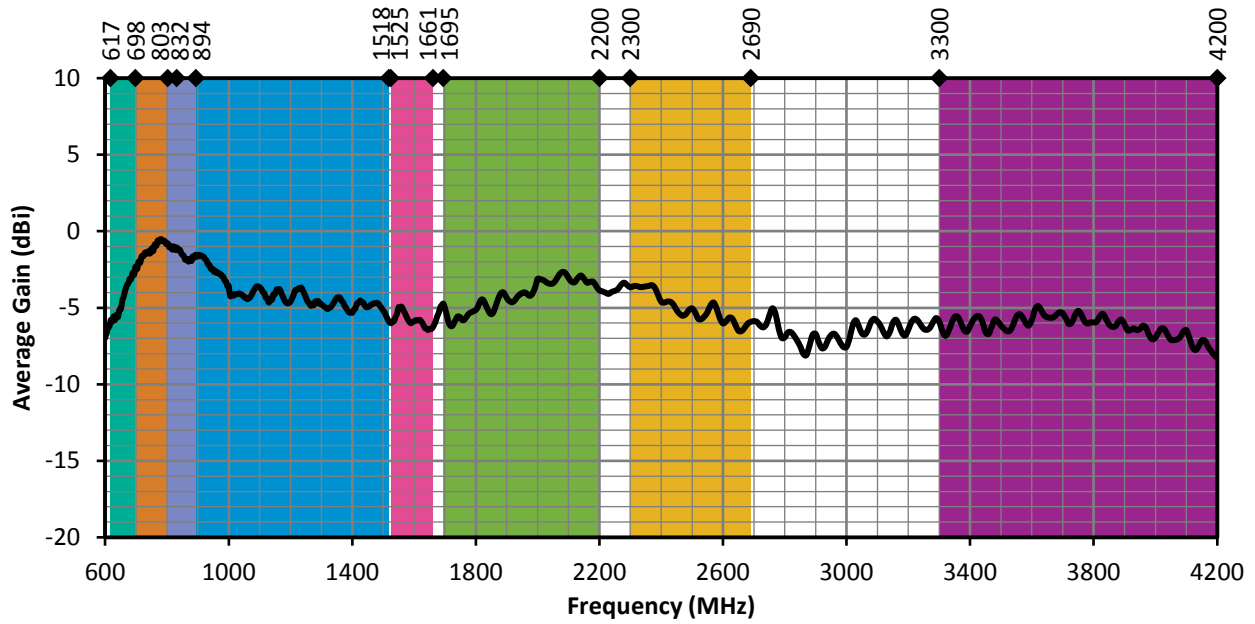

Figure 7. ANT-5GW-MMGI-SMA Antenna Average Gain on Ground Plane

RADIATION EFFICIENCY

Radiation efficiency (Figure 8), shows the ratio of power delivered to the antenna relative to the power radiated at the antenna, expressed as a percentage, where a higher percentage indicates better performance at a given frequency.

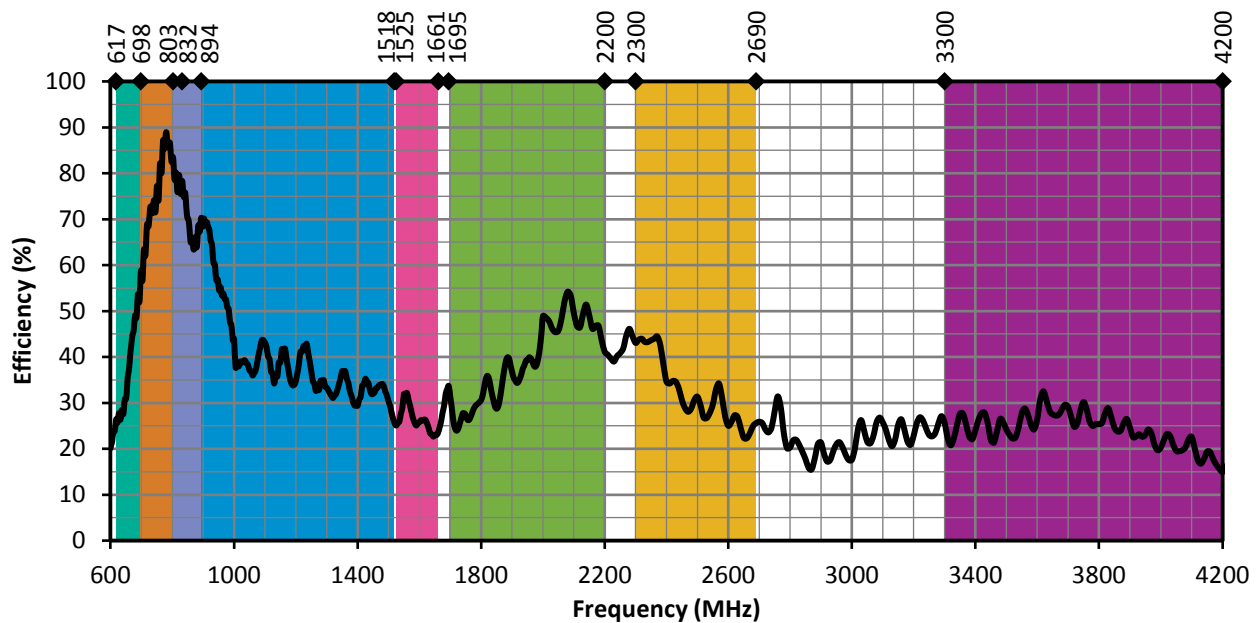
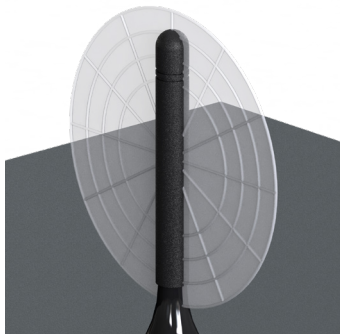

Figure 8. ANT-5GW-MMGI-SMA Antenna Efficiency on Ground Plane

RADIATION PATTERNS

Radiation patterns provide information about the directionality and 3-dimensional gain performance of the antenna by plotting gain at specific frequencies in three orthogonal planes. Antenna radiation patterns (Figure 9), are shown using polar plots covering 360 degrees. The antenna graphic above the plots provides reference to the plane of the column of plots below it. Note: when viewed with typical PDF viewing software, zooming into radiation patterns is possible to reveal fine detail.

RADIATION PATTERNS - ON GROUND PLANE



XZ-Plane Gain

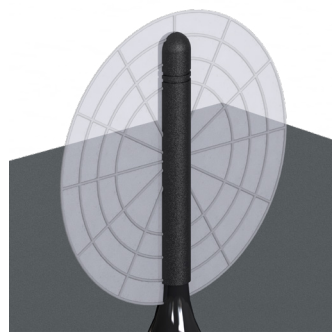

YZ-Plane Gain



XY-Plane Gain

617 MHz TO 698 MHz (660 MHz)

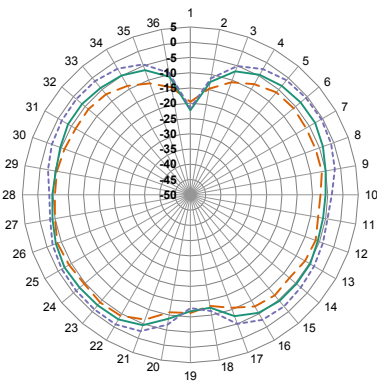

XZ-Plane Gain

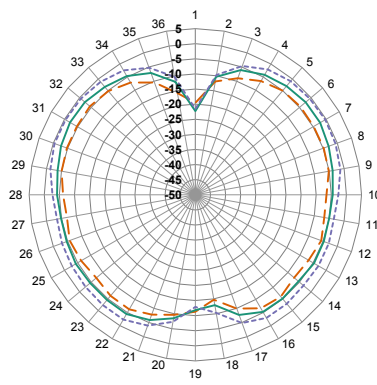

YZ-Plane Gain

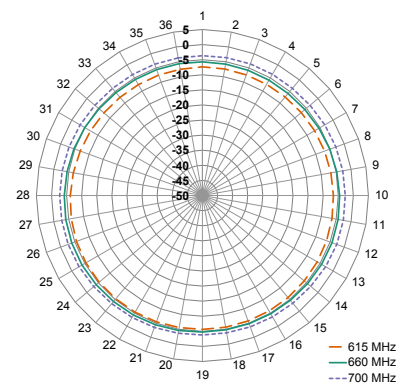

XY-Plane Gain

698 MHz TO 803 MHz (750 MHz)

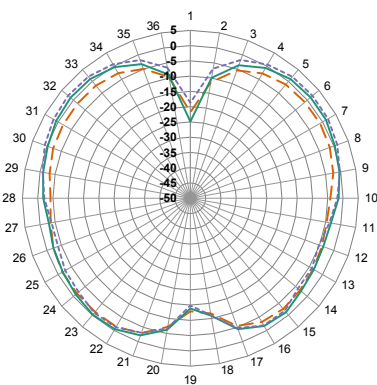

XZ-Plane Gain

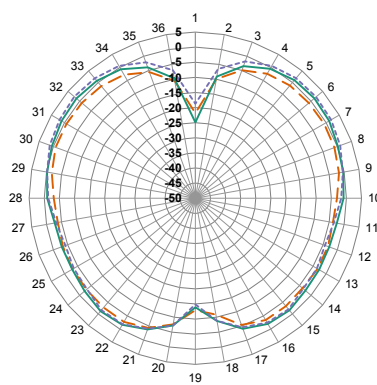

YZ-Plane Gain

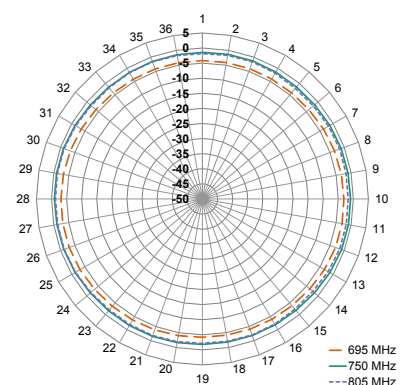

XY-Plane Gain

RADIATION PATTERNS

791 MHz TO 894 MHz (840 MHz)

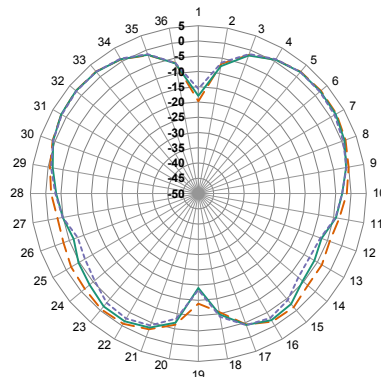

XZ-Plane Gain

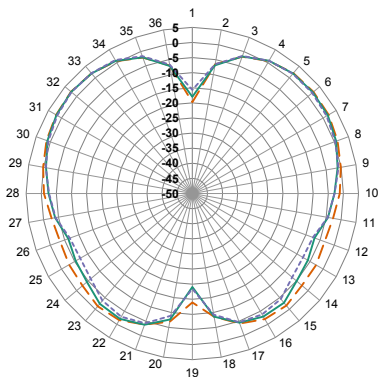

YZ-Plane Gain

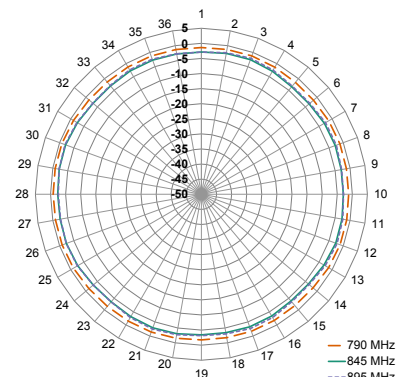

XY-Plane Gain

— 790 MHz
— 845 MHz
- - 895 MHz

832 MHz TO 1518 MHz (1175 MHz)

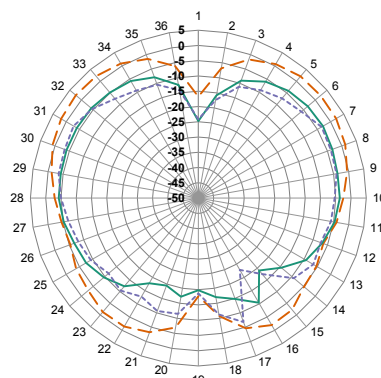

XZ-Plane Gain

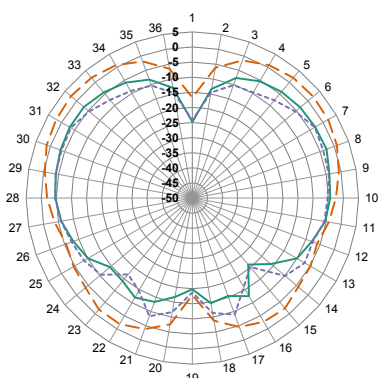

YZ-Plane Gain

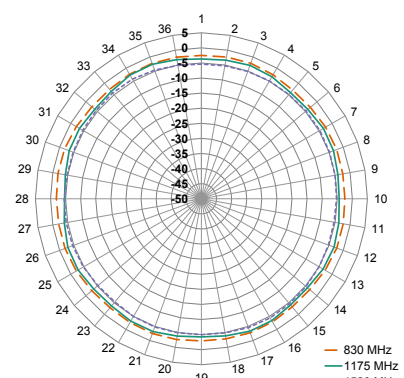

XY-Plane Gain

— 830 MHz
— 1175 MHz
- - 1520 MHz

1525 MHz TO 1661 MHz (1590 MHz)

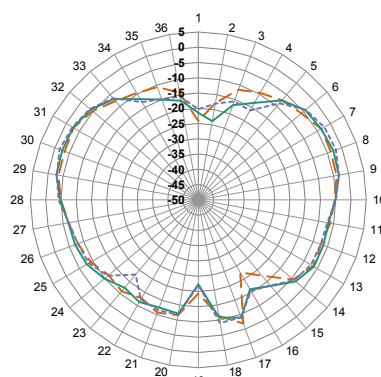

XZ-Plane Gain

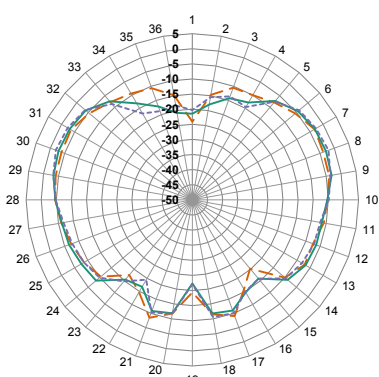

YZ-Plane Gain

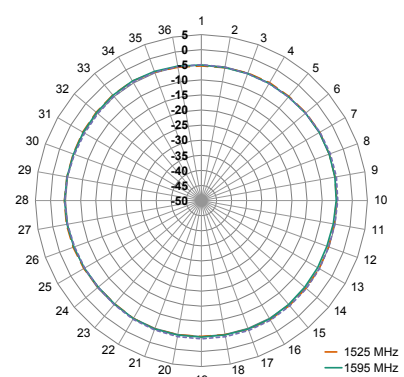

XY-Plane Gain

— 1525 MHz
— 1595 MHz
- - 1665 MHz

RADIATION PATTERNS

1695 MHz TO 2200 MHz (1945 MHz)

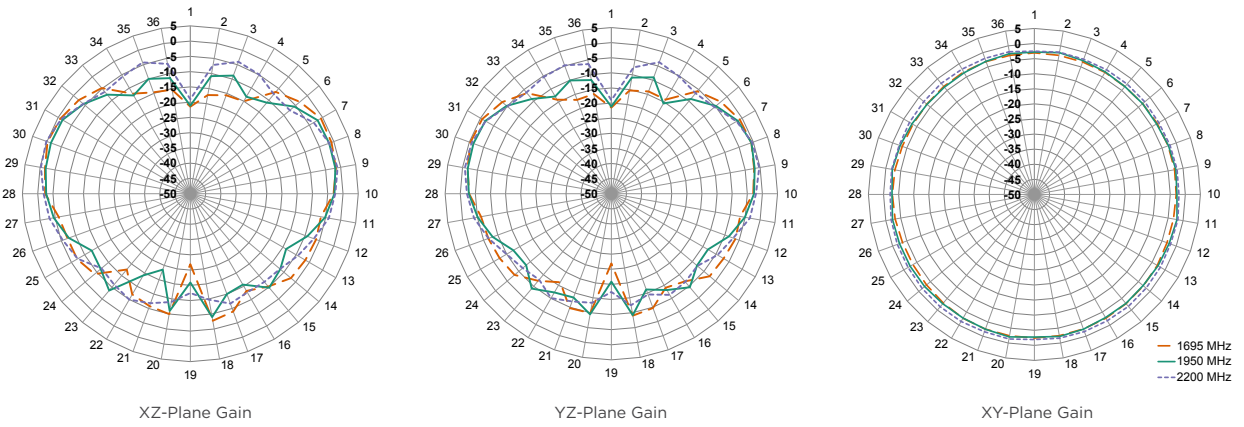

2300 MHz TO 2690 MHz (2490 MHz)

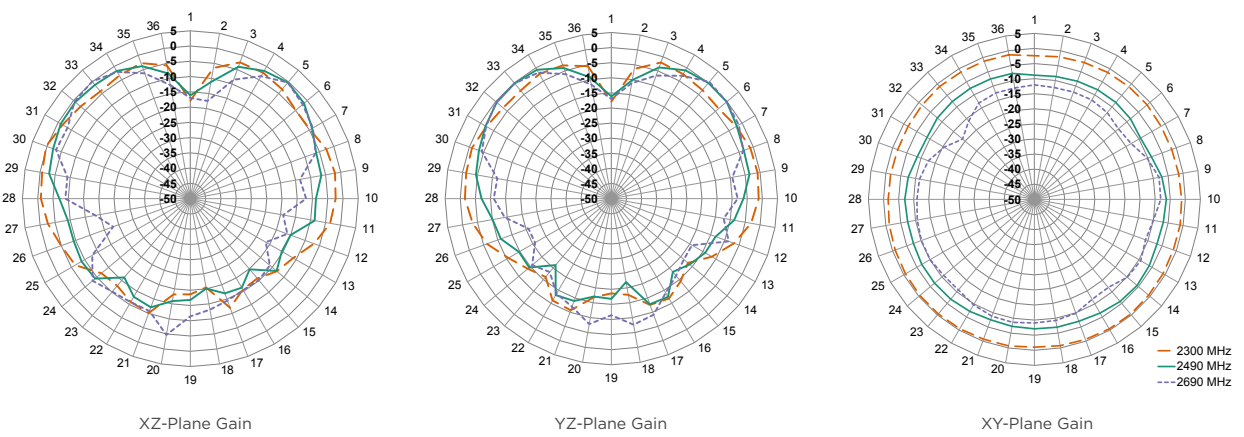

3300 MHz TO 4200 MHz (3750 MHz)

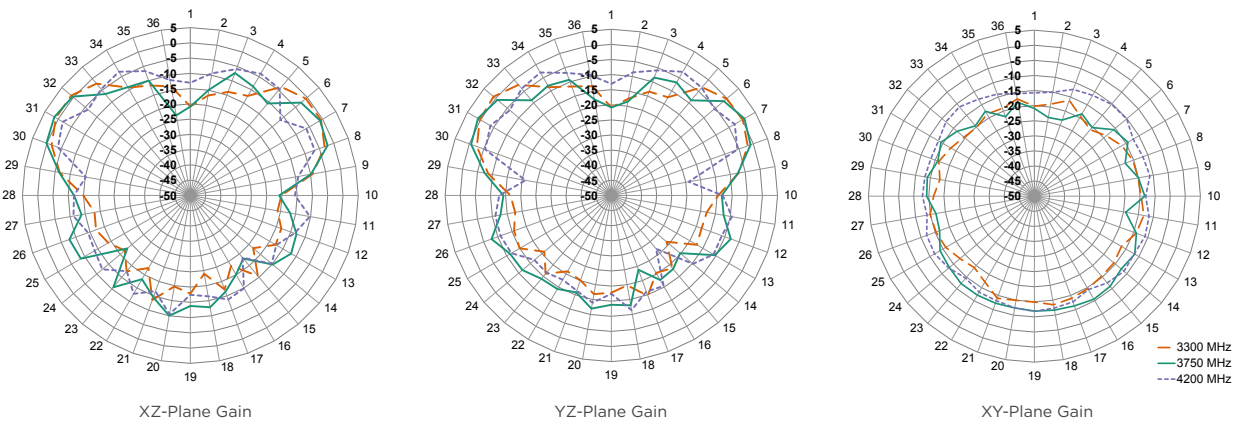

Figure 9. ANT-5GW-MMG1-SMA Radiation Patterns, on Ground Plane

FREE SPACE, NO GROUND PLANE

The charts on the following pages represent data taken with the antenna oriented in free space as shown in Figure 10.



Figure 10. ANT-5GW-MMG1-SMA No Ground Plane (Free Space)

VSWR

Figure 11 provides the voltage standing wave ratio (VSWR) across the antenna bandwidth. VSWR describes the power reflected from the antenna back to the radio. A lower VSWR value indicates better antenna performance at a given frequency. Reflected power is also shown on the right-side vertical axis as a gauge of the percentage of transmitter power reflected back from the antenna.

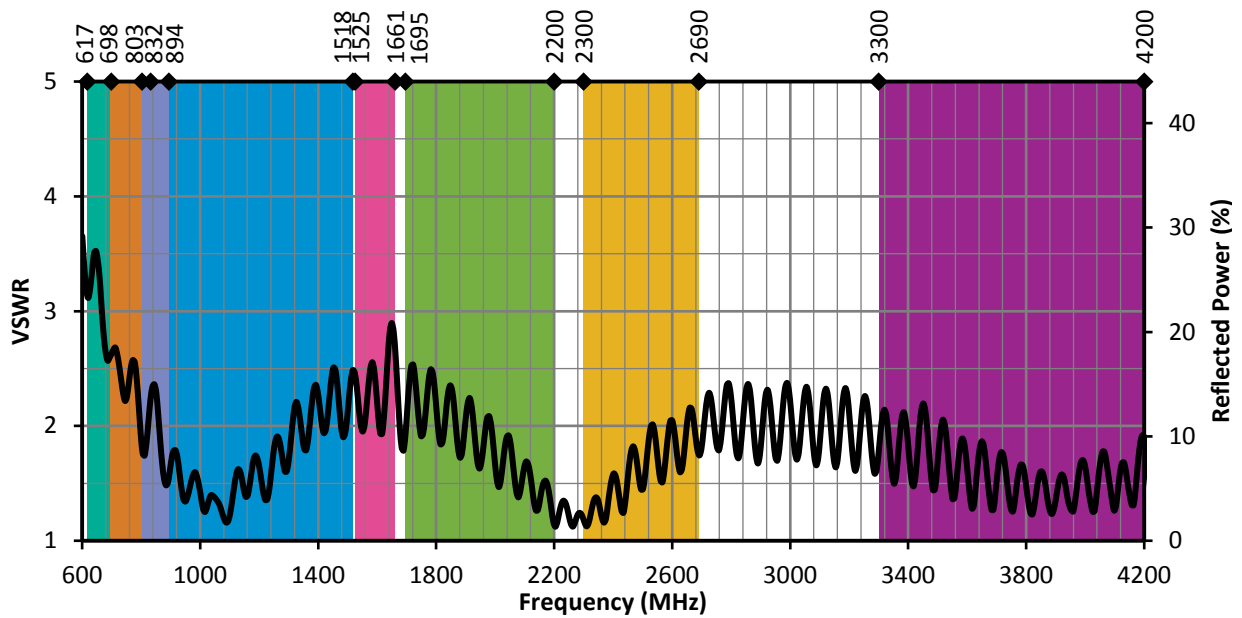

Figure 11. ANT-5GW-MMG1-SMA VSWR, Free Space

RETURN LOSS

Return loss (Figure 12), represents the loss in power at the antenna due to reflected signals. Like VSWR, a lower return loss value indicates better antenna performance at a given frequency.

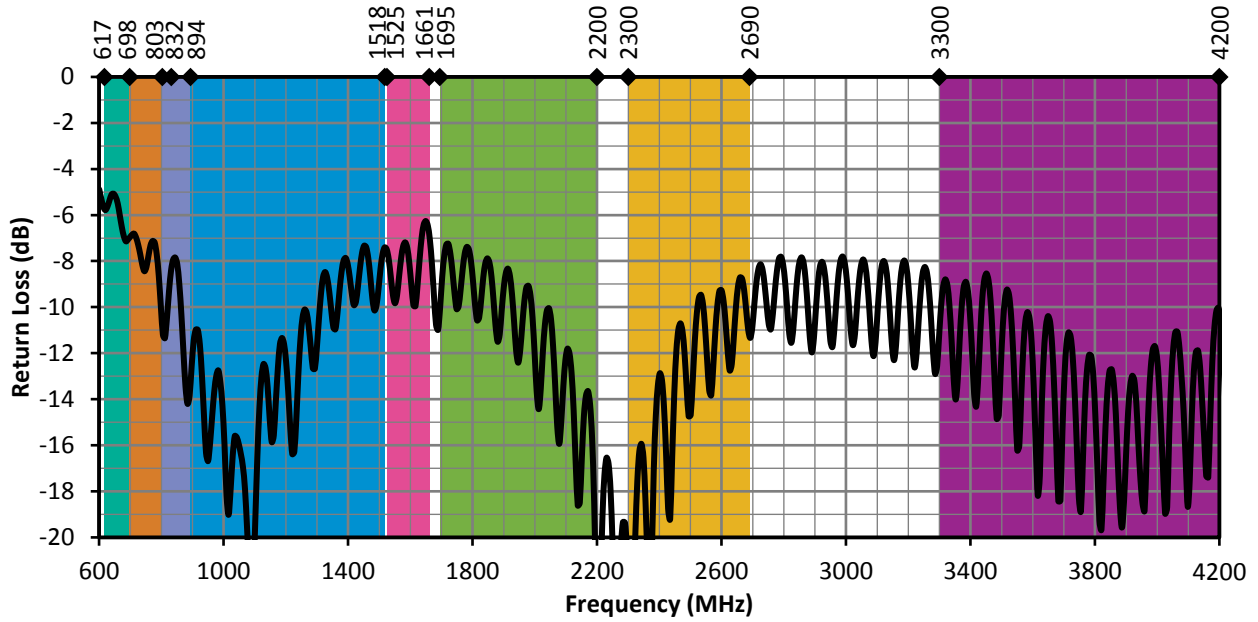

Figure 12. ANT-5GW-MMG1-SMA Return Loss, Free Space

PEAK GAIN

The peak gain across the antenna bandwidth is shown in Figure 13. Peak gain represents the maximum antenna input power concentration across 3-dimensional space, and therefore peak performance at a given frequency, but does not consider any directionality in the gain pattern.

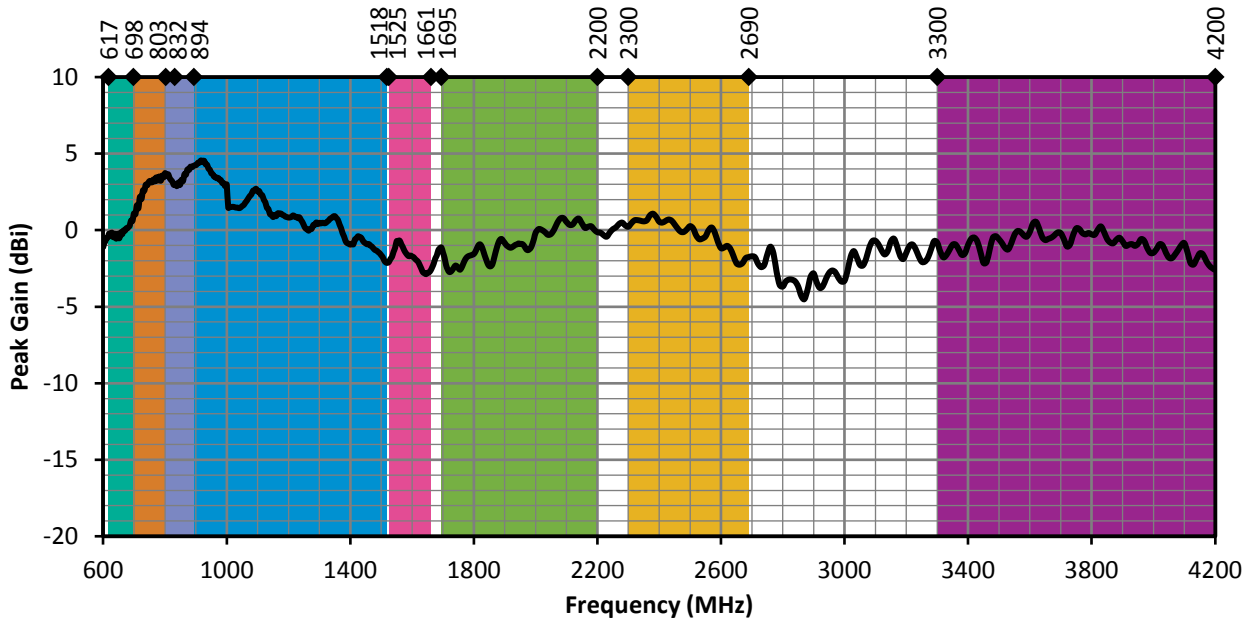

Figure 13. ANT-5GW-MMG1-SMA Peak Gain, Free Space

AVERAGE GAIN

Average gain (Figure 14), is the average of all antenna gain in 3-dimensional space at each frequency, providing an indication of overall performance without expressing antenna directionality.

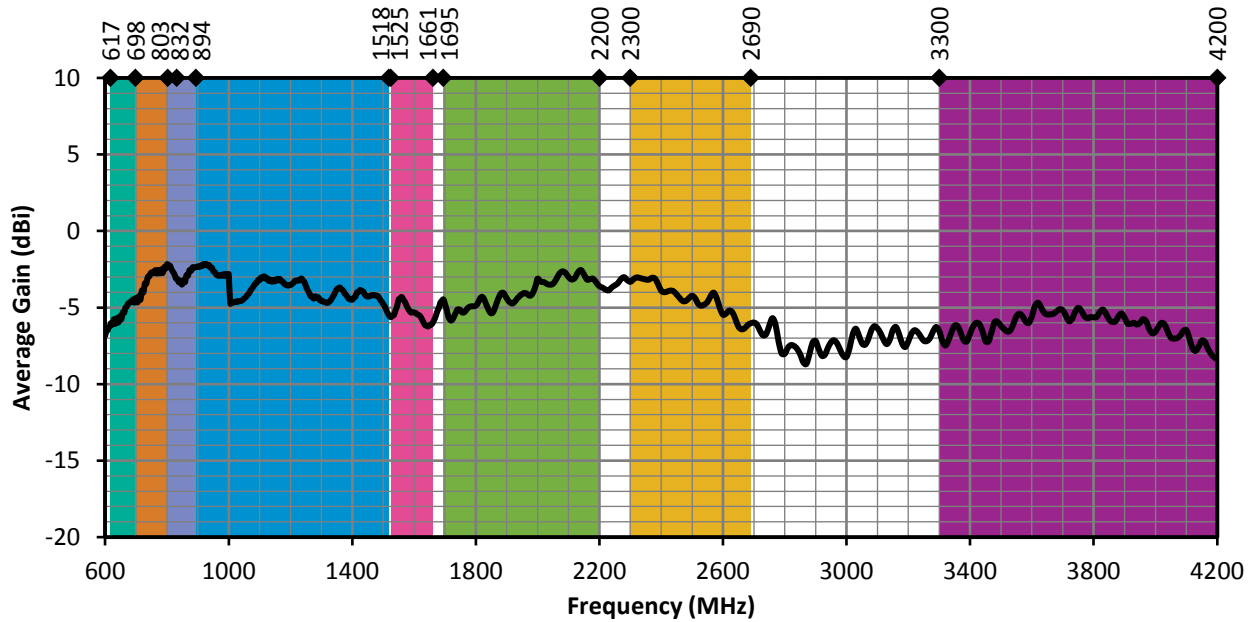

Figure 14. ANT-5GW-MMG1-SMA Antenna Average Gain, Free Space

RADIATION EFFICIENCY

Radiation efficiency (Figure 15), shows the ratio of power delivered to the antenna relative to the power radiated at the antenna, expressed as a percentage, where a higher percentage indicates better performance at a given frequency.

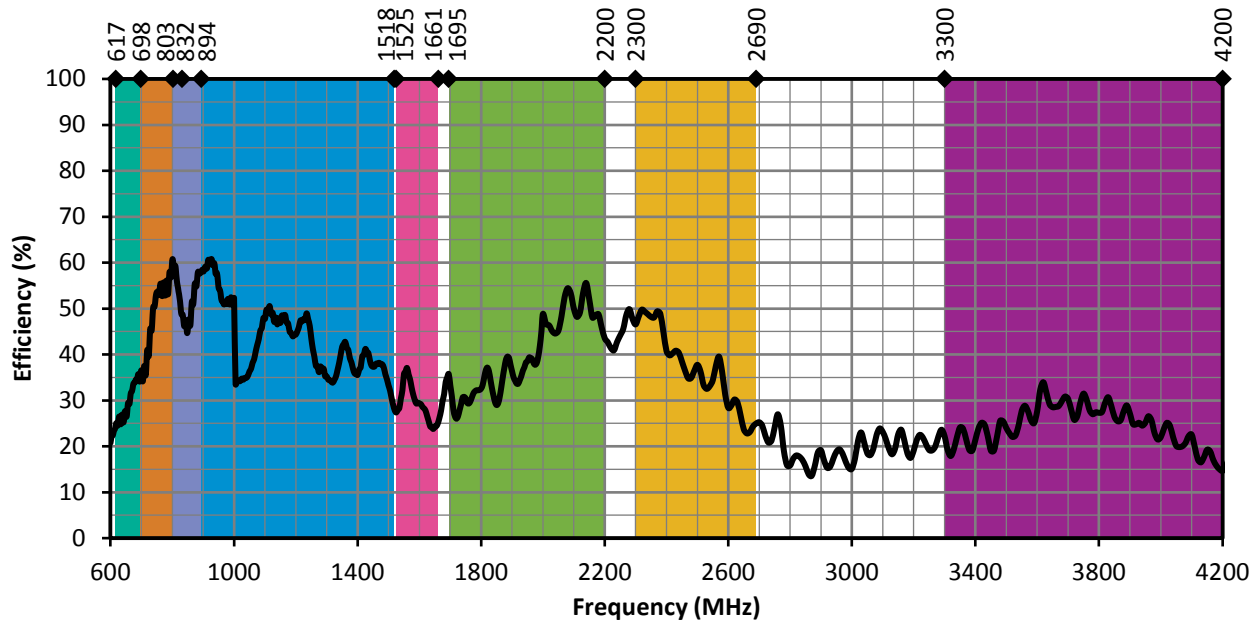

Figure 15. ANT-5GW-MMG2-SMA Antenna Efficiency, Free Space

RADIATION PATTERNS

Radiation patterns provide information about the directionality and 3-dimensional gain performance of the antenna by plotting gain at specific frequencies in three orthogonal planes. Antenna radiation patterns (Figure 16), are shown using polar plots covering 360 degrees. The antenna graphic above the plots provides reference to the plane of the column of plots below it. Note: when viewed with typical PDF viewing software, zooming into radiation patterns is possible to reveal fine detail.

RADIATION PATTERNS - FREE SPACE



XZ-Plane Gain



YZ-Plane Gain



XY-Plane Gain

617 MHz TO 698 MHz (660 MHz)

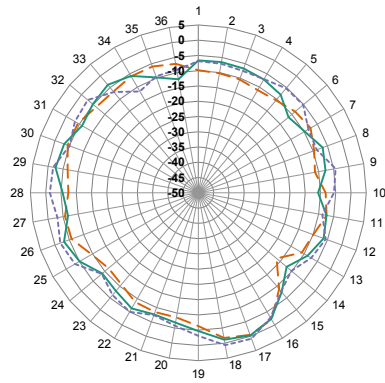

XZ-Plane Gain

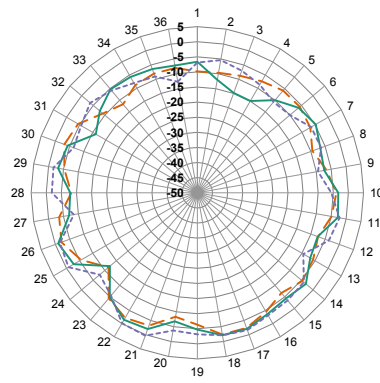

YZ-Plane Gain

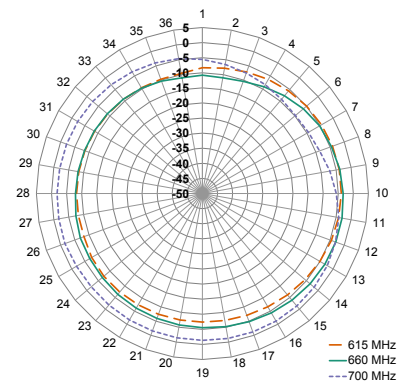

XY-Plane Gain

— 615 MHz
— 660 MHz
- - 700 MHz

698 MHz TO 803 MHz (750 MHz)

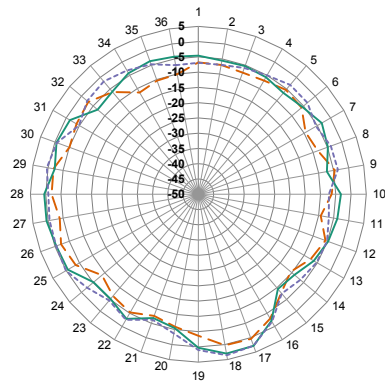

XZ-Plane Gain

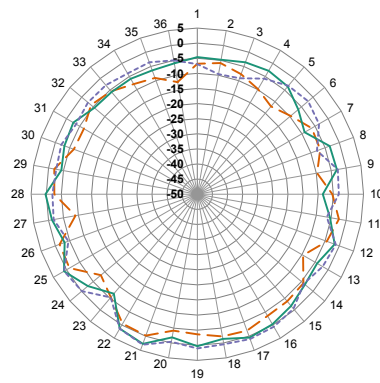

YZ-Plane Gain

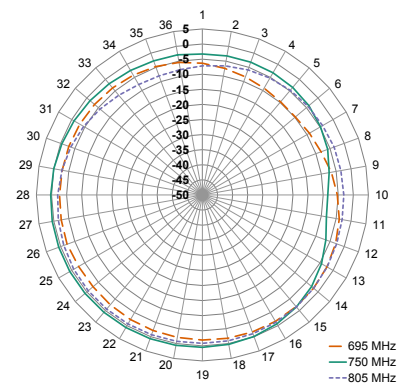

XY-Plane Gain

— 695 MHz
— 750 MHz
- - 805 MHz

RADIATION PATTERNS

791 MHz TO 894 MHz (840 MHz)

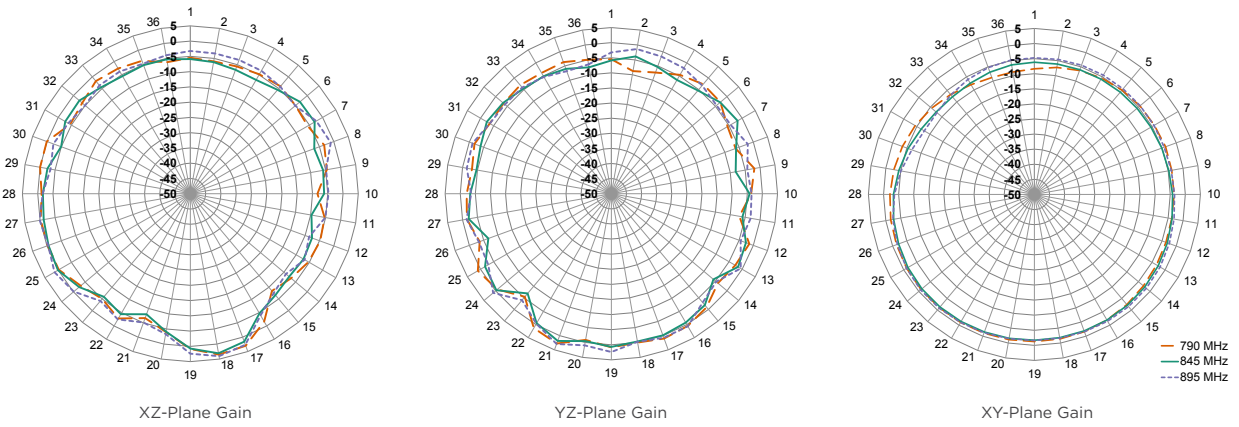

832 MHz TO 1518 MHz (1175 MHz)

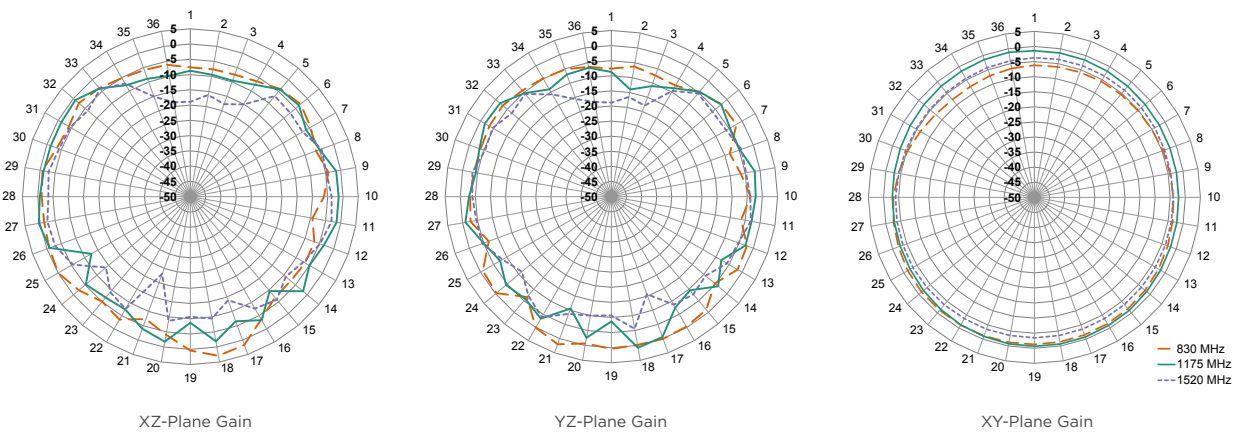

1525 MHz TO 1661 MHz (1590 MHz)

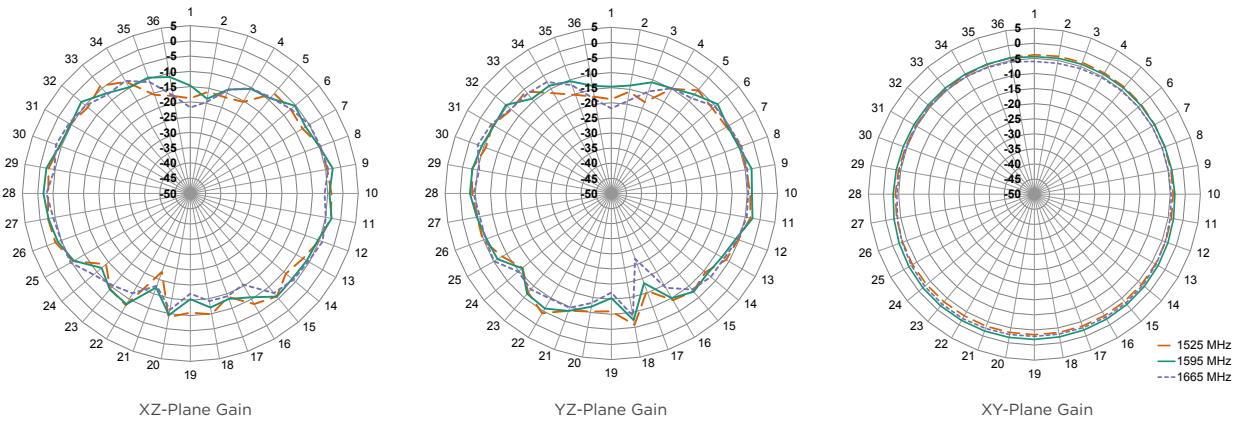
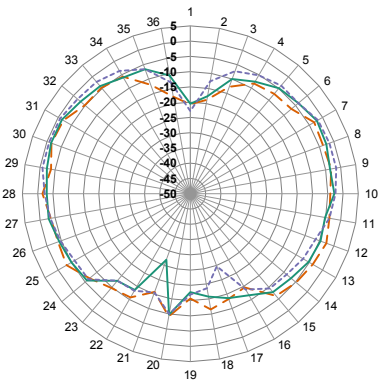

Figure 7. ANT-5GW-SPS1 Radiation Patterns

RADIATION PATTERNS

1695 MHz TO 2200 MHz (1945 MHz)



XZ-Plane Gain

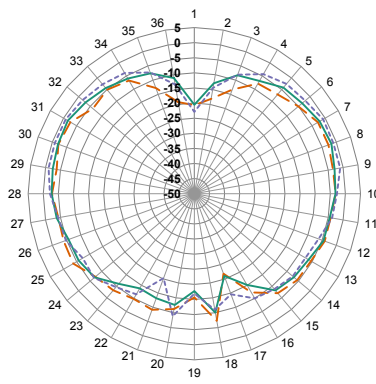

YZ-Plane Gain

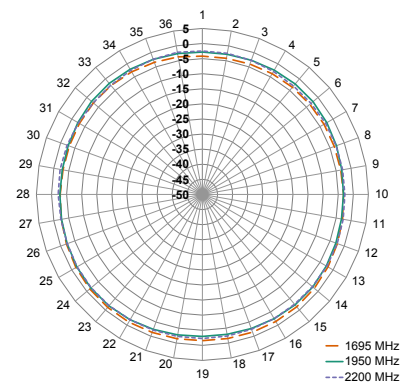

XY-Plane Gain

2300 MHz TO 2690 MHz (2490 MHz)

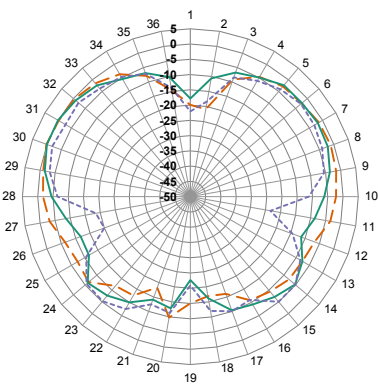

XZ-Plane Gain

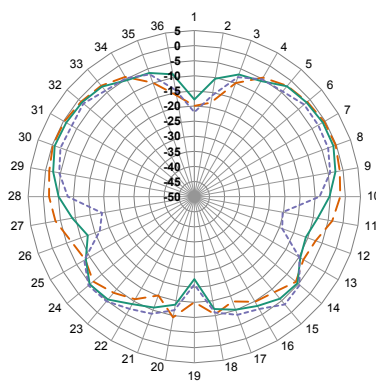

YZ-Plane Gain

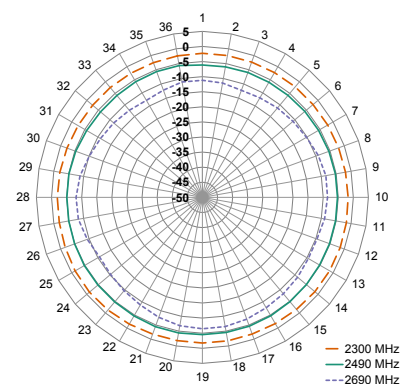

XY-Plane Gain

3300 MHz TO 4200 MHz (3750 MHz)

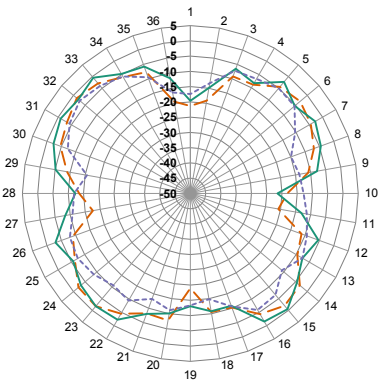

XZ-Plane Gain

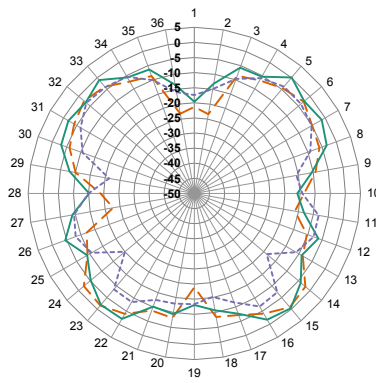

YZ-Plane Gain

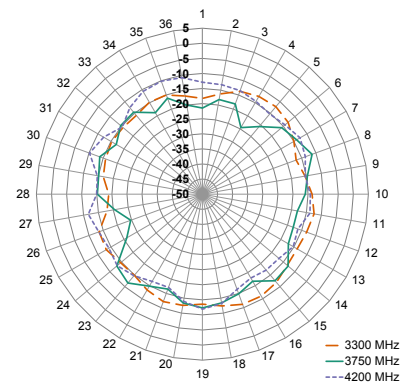

XY-Plane Gain

TE TECHNICAL SUPPORT CENTER

USA:	+1 (800) 522-6752
Canada:	+1 (905) 475-6222
Mexico:	+52 (0) 55-1106-0800
Latin/S. America:	+54 (0) 11-4733-2200
Germany:	+49 (0) 6251-133-1999
UK:	+44 (0) 800-267666
France:	+33 (0) 1-3420-8686
Netherlands:	+31 (0) 73-6246-999
China:	+86 (0) 400-820-6015

te.com

TE Connectivity, TE, TE connectivity (logo), Linx and Linx Technologies are trademarks owned or licensed by the TE Connectivity Ltd. family of companies. All other logos, products and/or company names referred to herein might be trademarks of their respective owners.

The information given herein, including drawings, illustrations and schematics which are intended for illustration purposes only, is believed to be reliable. However, TE Connectivity makes no warranties as to its accuracy or completeness and disclaims any liability in connection with its use. TE Connectivity's obligations shall only be as set forth in TE Connectivity's Standard Terms and Conditions of Sale for this product and in no case will TE Connectivity be liable for any incidental, indirect or consequential damages arising out of the sale, resale, use or misuse of the product. Users of TE Connectivity products should make their own evaluation to determine the suitability of each such product for the specific application.

TE Connectivity warrants to the original end user customer of its products that its products are free from defects in material and workmanship. Subject to conditions and limitations TE Connectivity will, at its option, either repair or replace any part of its products that prove defective because of improper workmanship or materials. This limited warranty is in force for the useful lifetime of the original end product into which the TE Connectivity product is installed. Useful lifetime of the original end product may vary but is not warranted to exceed one (1) year from the original date of the end product purchase.

©2022 TE Connectivity. All Rights Reserved.

10/22 Original

Mouser Electronics

Authorized Distributor

Click to View Pricing, Inventory, Delivery & Lifecycle Information:

[TE Connectivity:](#)

[ANT-5GW-MMG1-SMA-1](#)