

Data sheet | Item number: 2042-3869

Relay module; Nominal input voltage: 24 ... 230 V AC/DC; 1 break and 1 make contact; Limiting continuous current: 5 A; Green status indicator; Module width: 20 mm

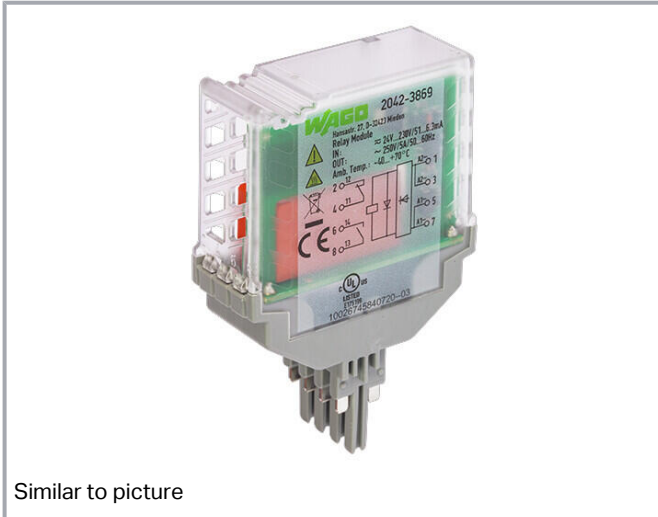

www.wago.com/2042-3869



Similar to picture

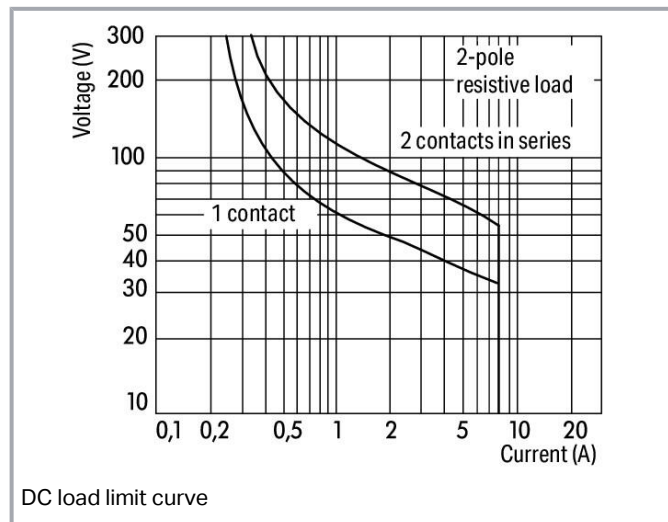
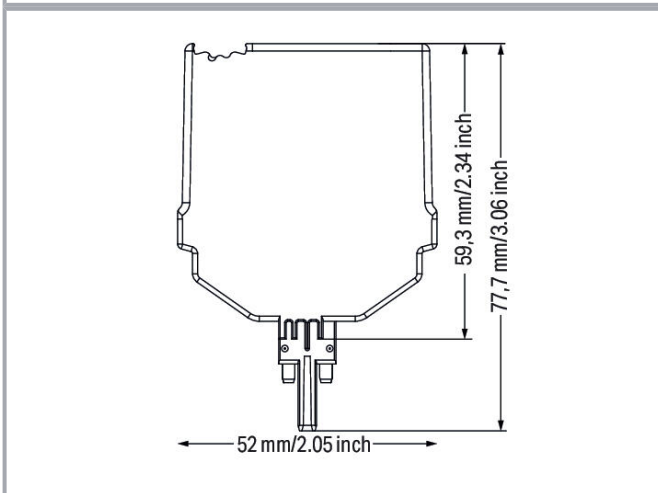
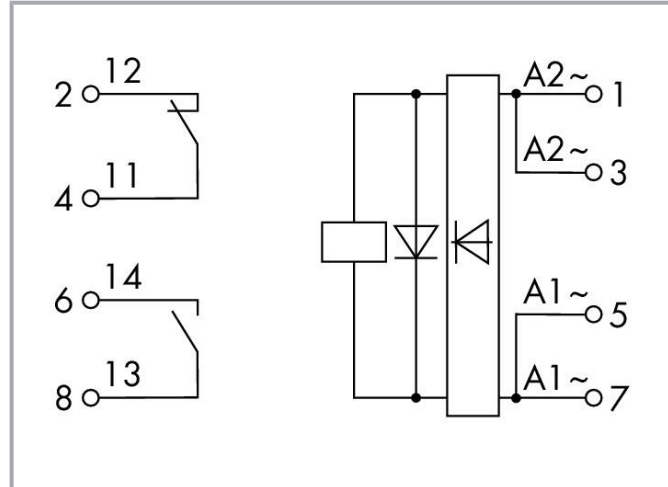

DC load limit curve

Data

Technical data

Control circuit

Nominal input voltage U_N	AC/DC 24 ... 230 V
Input voltage range	±10 %

Subject to changes. Please also observe the further product documentation!

WAGO GmbH & Co. KG
 Hansastr. 27
 32423 Minden
 Phone: +49571 887-0 | Fax: +49571 887-169
 Email: info.de@wago.com | Web: www.wago.com

Do you have any questions about our products?
 We are always happy to take your call at +49 (571) 887-44222.



Nominal input current at U_N	3 mA (230 V); 49.1 mA (24 V)
--------------------------------	------------------------------

Load circuit

Number of break/switch-off contacts	1
Number of make/switch-on contacts	1
Contact material (relay)	AgNi
Limiting continuous current	5 A
Inrush current (resistive) max.	(AC) 15 A / 4 s
Switching voltage (max.)	AC 250 V
Switching power (resistive) max.	AC 1250 VA; DC (see load limit curve)
Recommended minimum load	12 V / 10 mA
Pull-in time (typ.)	8 ms
Drop-out time (typ.)	6 ms
Bounce time (typ.)	4 ms
Electrical life (NO; resistive load; 23 °C)	100 x 10 ³ switching operations
Mechanical life	10 x 10 ⁶ switching operations

Signaling

Status indicator	Green LED
------------------	-----------

Safety and protection

Rated voltage	250 V
Pollution degree	2
Dielectric strength (control/load circuit) (AC, 1 min)	3 kVrms
Dielectric strength (open contact) (AC, 1 min)	1 kVrms
Dielectric strength (channel/channel) (AC, 1 min)	1.5 kVrms
Protection type	IP20

Physical data

Width	20.7 mm / 0.815 inches
Height	77.7 mm / 3.059 inches
Height from the surface	59.3 mm / 2.335 inches
Depth	52 mm / 2.047 inches

Mechanical data

Mounting type

Subject to changes. Please also observe the further product documentation!

WAGO GmbH & Co. KG
 Hansastr. 27
 32423 Minden
 Phone: +49571 887-0 | Fax: +49571 887-169
 Email: info.de@wago.com | Web: www.wago.com

Do you have any questions about our products?
 We are always happy to take your call at +49 (571) 887-44222.

Pluggable module for TOPJOB® S carrier terminal block

Material data

Flammability class per UL94	V0
Fire load	0.894 MJ
Weight	39.2 g

Environmental requirements

Ambient temperature (operation at U _N)	-40 ... +70 °C
Ambient temperature (storage)	-40 ... +85 °C
Processing temperature	-25 ... +50 °C
Operating altitude (max.)	2000 m

Standards and specifications

Standards/specifications	EN 61010-2-201 EN 61373 EN 50121-3-2
--------------------------	--

Commercial data

eCl@ss 10.0	27-14-11-49
eCl@ss 9.0	27-14-11-49
ETIM 8.0	EC002018
ETIM 7.0	EC002018
Recupel Type	
ECCN	NO DATA
PU (SPU)	4 pcs
Packaging type	box
Country of origin	DE
GTIN	4055143651950
Customs tariff number	85364900990

Environmental Product Compliance



CAS-No.	7439-92-1 79-94-7 80-05-7
REACH Candidate List Substance	2,2',6,6'-tetrabromo-4,4'-isopropylidenediphenol 4,4'-isopropylidenediphenol

Subject to changes. Please also observe the further product documentation!

	Lead
RoHS Compliance Status	Compliant,With Exemption
RoHS Exemption	6(c) 7(a) 7(c)-I 7(c)-II
SCIP notification number (Austria)	bb595074-3a69-4f51-9f30-22f4c92200d5
SCIP notification number (Belgium)	b9ecac12-4a1e-4536-8121-d79224e739cf
SCIP notification number (Bulgaria)	a7505d57-4380-46ff-999d-f435a5930cca
SCIP notification number (Czech Republic)	9d348084-02b1-4f3d-b97f-b8bfcea5da3b
SCIP notification number (Denmark)	85d230d3-4ef7-49dc-938f-6fcb393249b1
SCIP notification number (Finland)	9ae9c5e6-737d-4bbc-b408-cb751b8740ab
SCIP notification number (France)	4305dacb-5935-47b5-83cd-41f8a6438abb
SCIP notification number (Germany)	756feabb-ca46-4713-b687-71c3420bda13
SCIP notification number (Hungary)	9ef48e13-6e11-4d30-ab70-4a7869767f80
SCIP notification number (Italy)	e5e7cb4b-c2f7-456d-a857-d5dfcdd27dba
SCIP notification number (Netherlands)	515c829e-9b7e-4ebd-9d30-2aa377bc4992
SCIP notification number (Poland)	3c120409-c09a-44fd-8918-a8cde147b43e
SCIP notification number (Romania)	7c99eec4-ec92-477f-9131-24bf978551ce
SCIP notification number (Sweden)	56254a7e-779a-4213-b1eb-0e68fbbbb592

Approvals / Certificates

General approvals

Logo	Approval	Additional Approval Text	Certificate name
	EAC Brjansker Zertifizierungsstelle	TP TC 020/2011	EAC_Certificate_RU_C-DE.AM02.B.00115_19
	EAC Brjansker Zertifizierungsstelle	TP TC 004/2011	EAC RU C-DE.AM02.B.00122/19
	UL Underwriters Laboratories Inc. (ORDINARY LOCATIONS)	UL 61010-1	E175199

Declarations of conformity and manufacturer's declarations

Logo	Approval	Additional Approval Text	Certificate name
	EU-Declaration of Conformity	-	-

Subject to changes. Please also observe the further product documentation!











WAGO GmbH & Co. KG

Optional accessories

End plate

End plate



	Item no.: 2002-1892 End and intermediate plate; 1 mm thick; orange	www.wago.com/2002-1892
	Item no.: 2002-1891 End and intermediate plate; 1 mm thick; gray	www.wago.com/2002-1891
	Item no.: 2002-1991 End and intermediate plate; 1 mm thick; gray	www.wago.com/2002-1991
	Item no.: 2002-1992 End and intermediate plate; 1 mm thick; orange	www.wago.com/2002-1992
	Item no.: 2002-1691 End and intermediate plate; 1 mm thick; gray	www.wago.com/2002-1691
	Item no.: 2002-1692 End and intermediate plate; 1 mm thick; orange	www.wago.com/2002-1692
	Item no.: 2002-1791 End and intermediate plate; 1 mm thick; gray	www.wago.com/2002-1791
	Item no.: 2002-1792 End and intermediate plate; 1 mm thick; orange	www.wago.com/2002-1792

Marking accessories

Marking strip

	Item no.: 2009-110 Marking strips; for Smart Printer; on reel; not stretchable; plain; snap-on type; white	www.wago.com/2009-110
--	--	--

Marker

	Item no.: 2009-115 WMB-Inline; for Smart Printer; 1500 pieces on roll; stretchable 5 - 5.2 mm; plain; snap-on type; white	www.wago.com/2009-115
	Item no.: 793-501 WMB marking card; as card; not stretchable; plain; snap-on type; white	www.wago.com/793-501
	Item no.: 793-5501 WMB marking card; as card; for terminal block width 5 - 17.5 mm; stretchable 5 - 5.2 mm; plain; snap-on	www.wago.com/793-5501

Subject to changes. Please also observe the further product documentation!

type; white

Terminal blocks

Carrier terminal block for modules and plugs

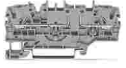
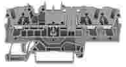
**Item no.: 2002-1961**2-conductor carrier terminal block; with additional jumper position; for DIN-rail 35 x 15 and 35 x 7.5; 2.5 mm²; Push-in CAGE CLAMP®; 2,50 mm²; gray www.wago.com/2002-1961**Item no.: 2002-1761**3-conductor carrier terminal block; for DIN-rail 35 x 15 and 35 x 7.5; 2.5 mm²; Push-in CAGE CLAMP®; 2,50 mm²; gray www.wago.com/2002-1761**Item no.: 2002-1861**4-conductor carrier terminal block; for DIN-rail 35 x 15 and 35 x 7.5; 2.5 mm²; Push-in CAGE CLAMP®; 2,50 mm²; gray www.wago.com/2002-1861

Downloads
Documentation**Bid Text**

2042-3869 docx - Datei	2019 Feb 20	docx 17.2 kB	Download
2042-3869 X81 - Datei	2019 Feb 19	xml 4.0 kB	Download

Instruction Leaflet

Pluggable Relay Module / Pluggable Solid-State Relay Module	V 1.1.0	pdf 2.0 MB	Download
---	---------	---------------	----------

Additional Information

Disposal and Recycling Electrical and electronic equipment, Batteries, Packaging	V 1.1.0 2022 Aug 18	pdf 2.2 MB	Download
---	------------------------	---------------	----------

CAD/CAE-Data**CAD data**

2D/3D Models 2042-3869	URL	Download
------------------------	-----	----------

CAE data

Subject to changes. Please also observe the further product documentation!

WAGO GmbH & Co. KG
 Hansastr. 27
 32423 Minden
 Phone: +49571 887-0 | Fax: +49571 887-169
 Email: info.de@wago.com | Web: www.wago.com

Do you have any questions about our products?
 We are always happy to take your call at +49 (571) 887-44222.



ZUKEN Portal 2042-3869

[URL](#)

[Download](#)

Asset Administration Shell

Asset Administration Shell 2042-3869

[URL](#)

[Download](#)

Environmental Product Compliance

Compliance Search

Environmental Product Compliance 2042-3869

[URL](#)

[Download](#)

Relay module; Nominal input voltage: 24 ... 230 V AC/DC; 1 break and 1 make contact;
Limiting continuous current: 5 A; Green status indicator; Module width: 20 mm

Installation Notes

Subject to changes. Please also observe the further product documentation!

WAGO GmbH & Co. KG

Hansastr. 27

32423 Minden

Phone: +49571 887-0 | Fax: +49571 887-169

Email: info.de@wago.com | Web: www.wago.com

Do you have any questions about our products?

We are always happy to take your call at +49 (571) 887-44222.