

## BLF 5.08HC/08/90LR SN BK BX

Weidmüller Interfaces GmbH & Co. KG

Postfach 3030

32760 Detmold

Tel. +49 5231 14-0

Fax. +49 5231 14-2083

info@weidmueller.com

www.weidmueller.com

### Product image

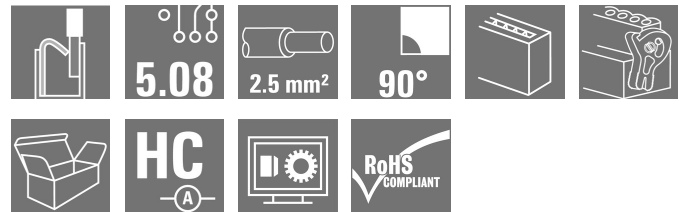

Just as reliable as the millionfold proven original and featuring innovative details:

The BLF 5.08HC PUSH IN version of the BLZP 5.08HC female connector is not only different in terms of connection system; it also has a more compact design. Weidmüller's innovative PUSH IN spring connection system stands for the future of easy and tool-free wire connection. HC = High Current.

In terms of versatility, the BLF 5.08HC offers just as much as the version which served as a model:

- 3 tested-and-proven wire outlet directions provide the usual flexibility for application-specific design
- 4 flange variations and the patented release latch allow the locking concept to be based on the requirements of the user
- Use the BLF 5.08HC and SL 5.08HC plug combination to reach the max. rated specifications

### General ordering data

Version	PCB plug-in connector, female plug, 5.08 mm, Number of poles: 8, 90°, PUSH IN with actuator, Tension-clamp connection, Clamping range, max. : 3.31 mm², Box
Order No.	<a href="#">1000470001</a>
Type	BLF 5.08HC/08/90LR SN BK BX
GTIN (EAN)	4032248690435
Qty.	36 pc(s).
Product data	IEC: 400 V / 24 A / 0.2 - 2.5 mm² UL: 300 V / 18.5 A / AWG 26 - AWG 12
Packaging	Box

## BLF 5.08HC/08/90LR SN BK BX

Weidmüller Interfaces GmbH &amp; Co. KG

Postfach 3030

32760 Detmold

Tel. +49 5231 14-0

Fax. +49 5231 14-2083

## Technical data

info@weidmuller.com

www.weidmuller.com

## Dimensions and weights

Depth	29.6 mm	Depth (inches)	1.165 inch
Height	20.6 mm	Height (inches)	0.811 inch
Width	50.46 mm	Width (inches)	1.987 inch
Net weight	19.333 g		

## Temperatures

Operating temperature, min.	-50 °C	Operating temperature, max.	100 °C
-----------------------------	--------	-----------------------------	--------

## System Parameters

Product family	OMNIMATE Signal - series BL/SL 5.08	Type of connection	Field connection
Wire connection method	PUSH IN with actuator, Tension-clamp connection	Pitch in mm (P)	5.08 mm
Pitch in inches (P)	0.2 inch	Conductor outlet direction	90°
Number of poles	8	L1 in mm	35,56 mm
L1 in inches	1.4 inch	Number of rows	1
Pin series quantity	1	Rated cross-section	2.5 mm <sup>2</sup>
Touch-safe protection acc. to DIN VDE 57 106	Safe from finger touch	Touch-safe protection acc. to DIN VDE 0470	IP20 plugged/ IP10 unplugged
Protection degree	IP20	Volume resistance	≤5 mΩ
Can be coded	Yes	Stripping length	10 mm
Screwdriver blade	0.6 x 3.5	Screwdriver blade standard	DIN 5264
Plugging cycles	25	Plugging force/pole, max.	7 N
Pulling force/pole, max.	5.5 N		

## Material data

Insulating material	PBT	Colour	black
Colour chart (similar)	RAL 9011	Insulating material group	IIIa
Comparative Tracking Index (CTI)	≥ 200	UL 94 flammability rating	V-0
Contact material	CuSn	Contact surface	tinned
Layer structure of plug contact	4...8 μm Sn hot-dip tinned	Storage temperature, min.	-40 °C
Storage temperature, max.	70 °C	Operating temperature, min.	-50 °C
Operating temperature, max.	100 °C	Temperature range, installation, min.	-30 °C
Temperature range, installation, max.	100 °C		

## Conductors suitable for connection

Clamping range, min.	0.13 mm <sup>2</sup>
Clamping range, max.	3.31 mm <sup>2</sup>
Wire connection cross section AWG, min.	AWG 26
Wire connection cross section AWG, max.	AWG 12
Solid, min. H05(07) V-U	0.2 mm <sup>2</sup>
Solid, max. H05(07) V-U	2.5 mm <sup>2</sup>
Flexible, min. H05(07) V-K	0.2 mm <sup>2</sup>
Flexible, max. H05(07) V-K	2.5 mm <sup>2</sup>
w. plastic collar ferrule, DIN 46228 pt 4, 0.25 mm <sup>2</sup> min.	
w. plastic collar ferrule, DIN 46228 pt 4, 2.5 mm <sup>2</sup> max.	
w. wire end ferrule, DIN 46228 pt 1, 0.25 mm <sup>2</sup> min.	

**BLF 5.08HC/08/90LR SN BK BX**

**Weidmüller Interfaces GmbH & Co. KG**

Postfach 3030

32760 Detmold

Tel. +49 5231 14-0

Fax. +49 5231 14-2083

info@weidmueller.com

www.weidmueller.com

**Technical data**

w. wire end ferrule, DIN 46228 pt 1, max. 2.5 mm<sup>2</sup>

Plug gauge in accordance with EN 60999 a x b; ø 2.8 mm x 2.0 mm

Clampable conductor

Cross-section for conductor connection	Type	fine-wired
	nominal	0.5 mm <sup>2</sup>
wire end ferrule	Stripping length	nominal 12 mm
	Recommended wire-end ferrule	<a href="#">H0,5/16 OR</a>
	Stripping length	nominal 10 mm
	Recommended wire-end ferrule	<a href="#">H0,5/10</a>
Cross-section for conductor connection	Type	fine-wired
	nominal	0.75 mm <sup>2</sup>
wire end ferrule	Stripping length	nominal 12 mm
	Recommended wire-end ferrule	<a href="#">H0,75/16 W</a>
	Stripping length	nominal 10 mm
	Recommended wire-end ferrule	<a href="#">H0,75/10</a>
Cross-section for conductor connection	Type	fine-wired
	nominal	1 mm <sup>2</sup>
wire end ferrule	Stripping length	nominal 12 mm
	Recommended wire-end ferrule	<a href="#">H1,0/16DR</a>
	Stripping length	nominal 10 mm
	Recommended wire-end ferrule	<a href="#">H1,0/10</a>
Cross-section for conductor connection	Type	fine-wired
	nominal	1.5 mm <sup>2</sup>
wire end ferrule	Stripping length	nominal 10 mm
	Recommended wire-end ferrule	<a href="#">H1,5/10</a>
	Stripping length	nominal 12 mm
	Recommended wire-end ferrule	<a href="#">H1,5/16 R</a>
Cross-section for conductor connection	Type	fine-wired
	nominal	2.5 mm <sup>2</sup>
wire end ferrule	Stripping length	nominal 10 mm
	Recommended wire-end ferrule	<a href="#">H2,5/10</a>
	Stripping length	nominal 13 mm
	Recommended wire-end ferrule	<a href="#">H2,5/16DS BL</a>

Reference text

The outside diameter of the plastic collar should not be larger than the pitch (P), Length of ferrules is to be chosen depending on the product and the rated voltage.

**BLF 5.08HC/08/90LR SN BK BX**

**Weidmüller Interfaces GmbH & Co. KG**

Postfach 3030

32760 Detmold

Tel. +49 5231 14-0

Fax. +49 5231 14-2083

**Technical data**

info@weidmueller.com

www.weidmueller.com

**Rated data acc. to IEC**

tested acc. to standard	IEC 60664-1, IEC 61984	Rated current, min. number of poles (Tu=20°C)	24 A
Rated current, max. number of poles (Tu=20°C)	19 A	Rated current, min. number of poles (Tu=40°C)	21 A
Rated current, max. number of poles (Tu=40°C)	16,5 A	Rated voltage for surge voltage class / pollution degree II/2	400 V
Rated voltage for surge voltage class / pollution degree III/2	320 V	Rated voltage for surge voltage class / pollution degree III/3	250 V
Rated impulse voltage for surge voltage class/ pollution degree II/2	4 kV	Rated impulse voltage for surge voltage class/ pollution degree III/2	4 kV
Rated impulse voltage for surge voltage class/ contamination degree III/3	4 kV	Short-time withstand current resistance	3 x 1s with 120 A

**Rated data acc. to CSA**

Institute (CSA)		Certificate No. (CSA)	200039-1121690
Rated voltage (Use group B / CSA)	300 V	Rated voltage (Use group D / CSA)	300 V
Rated current (Use group B / CSA)	10 A	Rated current (Use group D / CSA)	10 A
Wire cross-section, AWG, min.	AWG 12	Wire cross-section, AWG, max.	AWG 26
Reference to approval values	Specifications are maximum values, details - see approval certificate.		

**Rated data acc. to UL 1059**

Institute (cURus)		Certificate No. (cURus)	E60693
Rated voltage (Use group B / UL 1059)	300 V	Rated voltage (Use group D / UL 1059)	300 V
Rated current (Use group B / UL 1059)	18,5 A	Rated current (Use group D / UL 1059)	10 A
Wire cross-section, AWG, min.	AWG 26	Wire cross-section, AWG, max.	AWG 12
Reference to approval values	Specifications are maximum values, details - see approval certificate.		

**Packing**

Packaging	Box	VPE length	349 mm
VPE width	136 mm	VPE height	33 mm

**Type tests**

Test: Durability of markings	Standard	DIN EN 61984 section 7.3.2 / 09.02 taking pattern from DIN EN 60068-2-70 / 07.96
	Test	mark of origin, type identification, pitch, type of material, date clock
	Evaluation	available
	Test	durability
	Evaluation	passed

**BLF 5.08HC/08/90LR SN BK BX**

**Weidmüller Interfaces GmbH & Co. KG**

Postfach 3030

32760 Detmold

Tel. +49 5231 14-0

**Technical data**

Fax +49 5231 14-2083

Test: Misengagement (Non-interchangeability)	Standard	DIN EN 61984 section 6.3 and 6.9.1 / 09.02, DIN EN 60947-1 section 8.2.4.5.1 / 04.08	
	Test	180° turned with coding elements	
	Evaluation	passed	
	Test	visual examination	
Test: Clampable cross section	Evaluation	passed	
	Standard	DIN EN 60999-1 section 7 and 9.1 / 12.00, DIN EN 60947-1 section 8.2.4.5.1 / 04.08	
	Conductor type	Type of conductor and conductor cross-section	solid 0.2 mm <sup>2</sup>
		Type of conductor and conductor cross-section	stranded 0.2 mm <sup>2</sup>
		Type of conductor and conductor cross-section	solid 2.5 mm <sup>2</sup>
		Type of conductor and conductor cross-section	stranded 2.5 mm <sup>2</sup>
		Type of conductor and conductor cross-section	AWG 26/1
		Type of conductor and conductor cross-section	AWG 26/19
		Type of conductor and conductor cross-section	AWG 14/1
Type of conductor and conductor cross-section		AWG 14/19	
Evaluation	passed		

**BLF 5.08HC/08/90LR SN BK BX**

**Weidmüller Interfaces GmbH & Co. KG**

Postfach 3030

32760 Detmold

Tel. +49 5231 14-0

**Technical data**

Fax. +49 5231 14-2083

Test for damage to and accidental loosening of conductors

Standard	DIN EN 60999-1 section 9.4 / 12.00	
Requirement	0.2 kg info@weidmueller.com	
Conductor type	Type of conductor and conductor cross-section	AWG 26/1 info@weidmueller.com
	Type of conductor and conductor cross-section	AWG 26/19
Evaluation	passed	
Requirement	0.3 kg	
Conductor type	Type of conductor and conductor cross-section	H05V-U0.5
	Type of conductor and conductor cross-section	H05V-K0.5
Evaluation	passed	
Requirement	0.7 kg	
Conductor type	Type of conductor and conductor cross-section	H07V-U2.5
	Type of conductor and conductor cross-section	H07V-K2.5
Evaluation	passed	
Requirement	0.9 kg	
Conductor type	Type of conductor and conductor cross-section	AWG 12/1
	Type of conductor and conductor cross-section	AWG 12/19
Evaluation	passed	

## BLF 5.08HC/08/90LR SN BK BX

Weidmüller Interfaces GmbH &amp; Co. KG

Postfach 3030

32760 Detmold

Tel. +49 5231 14-0

Fax. +49 5231 14-2083

## Technical data

Pull-out test	Standard	DIN EN 60999-1 section 9.5 / 12.00	
	Requirement	≥10 N info@weidmueller.com	
Conductor type	Type of conductor and conductor cross-section	AWG 26/1	info@weidmueller.com
	Type of conductor and conductor cross-section	AWG 26/19	
Evaluation	passed		
Requirement	≥20 N		
Conductor type	Type of conductor and conductor cross-section	H05V-U0.5	
	Type of conductor and conductor cross-section	H05V-K0.5	
Evaluation	passed		
Requirement	≥50 N		
Conductor type	Type of conductor and conductor cross-section	H07V-U2.5	
	Type of conductor and conductor cross-section	H07V-K2.5	
Evaluation	passed		
Requirement	≥60 N		
Conductor type	Type of conductor and conductor cross-section	AWG 12/1	
	Type of conductor and conductor cross-section	AWG 12/19	
Evaluation	passed		

## Classifications

ETIM 6.0	EC002638	ETIM 7.0	EC002638
ETIM 8.0	EC002638	ECLASS 9.0	27-44-03-09
ECLASS 9.1	27-44-03-09	ECLASS 10.0	27-44-03-09
ECLASS 11.0	27-46-02-02	ECLASS 12.0	27-46-02-02

## BLF 5.08HC/08/90LR SN BK BX

**Weidmüller Interfaces GmbH & Co. KG**

Postfach 3030

32760 Detmold

Tel. +49 5231 14-0

Fax. +49 5231 14-2083

[info@weidmueller.com](mailto:info@weidmueller.com)

[www.weidmuller.com](http://www.weidmuller.com)

## Technical data

### Important note

IPC conformity Conformity: The products are developed, manufactured and delivered according to international recognized standards and norms and comply with the assured properties in the data sheet resp. fulfill decorative properties in accordance with IPC-A-610 "Class 2". Further claims on the products can be evaluated on request.

- Notes
- Additional variants on request
  - Gold-plated contact surfaces on request
  - Rated current related to rated cross-section & min. No. of poles.
  - Wire end ferrule without plastic collar to DIN 46228/1
  - Wire end ferrule with plastic collar to DIN 46228/4
  - P on drawing = pitch
  - Crimping shape "A" for wire end ferrules with PZ 6/5 crimping tool recommended.
  - The test point can only be used as potential-pickup point.
  - Long term storage of the product with average temperature of 50 °C and average humidity 70%, 36 months

### Approvals

Approvals



ROHS	Conform
UL File Number Search	UL Website
Certificate No. (cURus)	E60693

### Downloads

Approval/Certificate/Document of Conformity	<a href="#">Declaration of the Manufacturer</a>
Engineering Data	<a href="#">CAD data – STEP</a>
Engineering Data	<a href="#">WSCAD</a>
Catalogues	<a href="#">Catalogues in PDF-format</a>
Brochures	<a href="#">FL DRIVES EN</a> <a href="#">MB DEVICE MANUF. EN</a> <a href="#">FL DRIVES DE</a> <a href="#">FL BUILDING SAFETY EN</a> <a href="#">FL APPL LED LIGHTING EN</a> <a href="#">FLIndustr.CONTROLS EN</a> <a href="#">FL MACHINE SAFETY EN</a> <a href="#">FL HEATING ELECTR EN</a> <a href="#">FL APPL INVERTER EN</a> <a href="#">FL_BASE_STATION_EN</a> <a href="#">FL ELEVATOR EN</a> <a href="#">FL POWER SUPPLY EN</a> <a href="#">FL 72H SAMPLE SER EN</a> <a href="#">PO OMNIMATE EN</a> <a href="#">PO OMNIMATE EN</a>



**BLF 5.08HC/08/90LR SN BK BX**

Weidmüller Interfaces GmbH & Co. KG

Postfach 3030

32760 Detmold

Tel. +49 5231 14-0

Fax. +49 5231 14-2083

Drawings

Product image



Dimensional drawing [info@weidmueller.com](mailto:info@weidmueller.com)

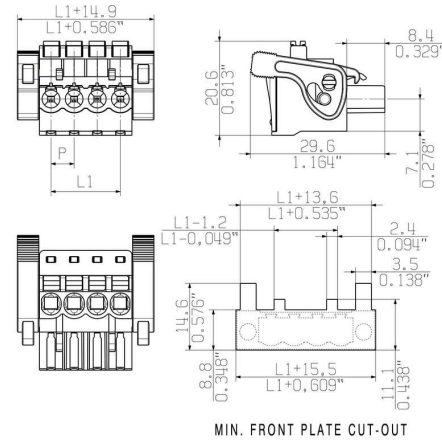

Graph

BLF 5.08HC/./90 - SL 5.08HC/./90

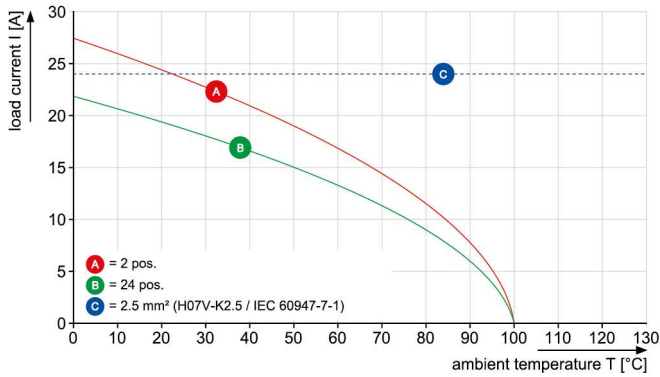

Graph

BLF 5.08HC/./90 - SL 5.08HC/./90

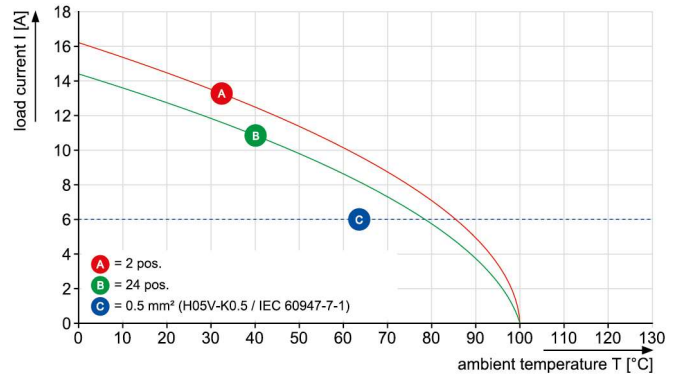

Uncompromising functionality  
High vibration resistance

**BLF 5.08HC/08/90LR SN BK BX**

**Weidmüller Interfaces GmbH & Co. KG**

Postfach 3030

32760 Detmold

Tel. +49 5231 14-0

Fax. +49 5231 14-2083

info@weidmueller.com

**Drawings**

**Product benefits**



Solid PUSH IN contact  
Safe and durable

**Product benefits**

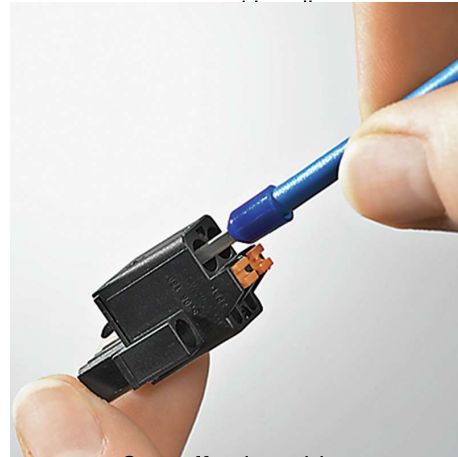

Cost-effective wiring  
Quick and intuitive operation

**Product benefits**



Wide clamping range  
Tool-free wire connection

**Data sheet**

**BLF 5.08HC/08/90LR SN BK BX**

**Weidmüller Interfaces GmbH & Co. KG**

Postfach 3030

32760 Detmold

Tel. +49 5231 14-0

Fax. +49 5231 14-2083

info@weidmueller.com

**Drawings**

**Product benefits**

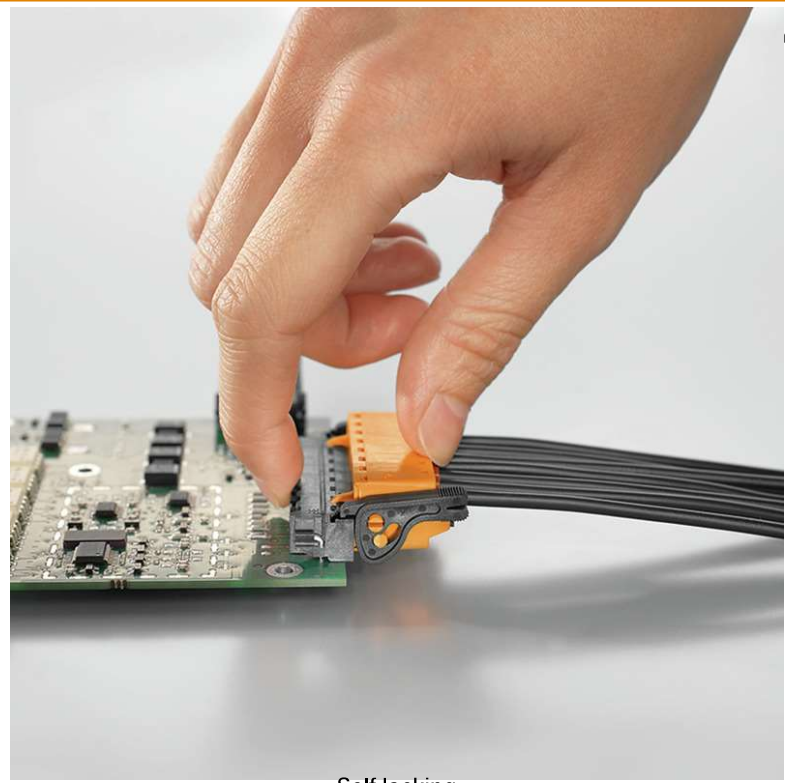

ueller.com

Self-locking

Immediately on plugging in

**Uncompromising functionality**  
**High vibration resistant**

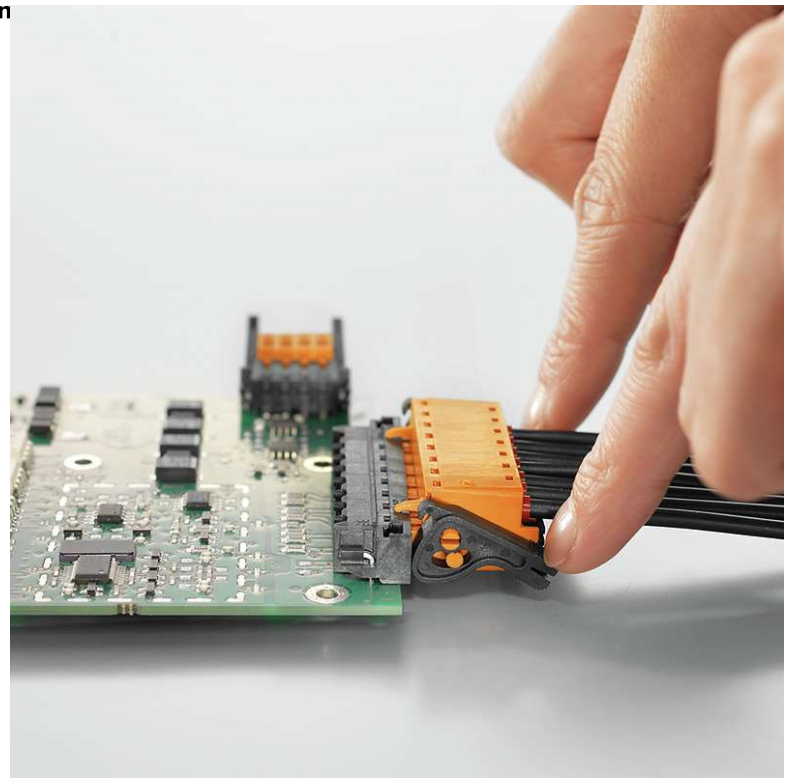

MASSE OHNE TOLERANZ SIND KEINE PRUEFMASSE  
DIMS. WITHOUT TOLERANCE ARE NOT CONTROL DIMS.

SHOWN: BLF 5.08HC/04/90G SN ...

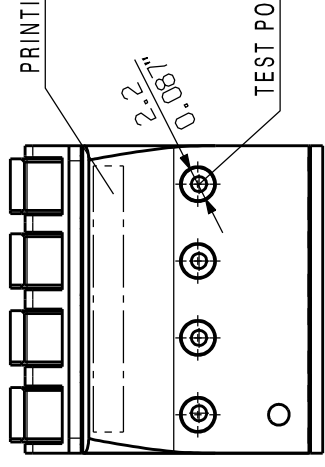
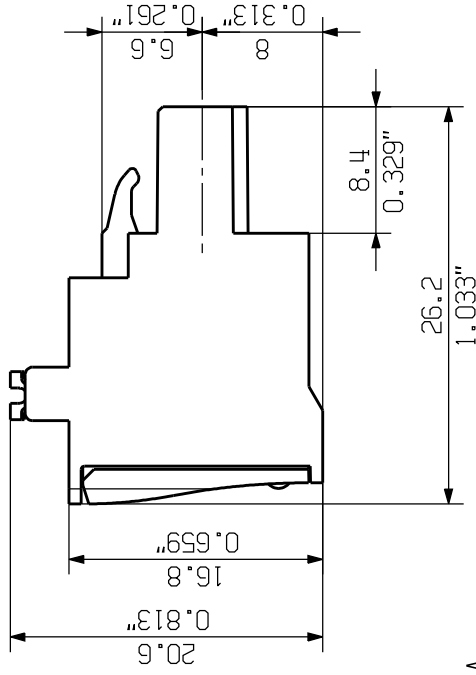
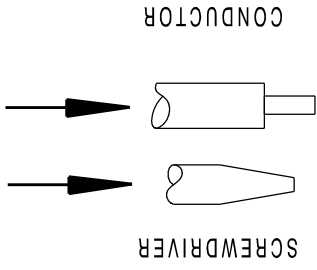
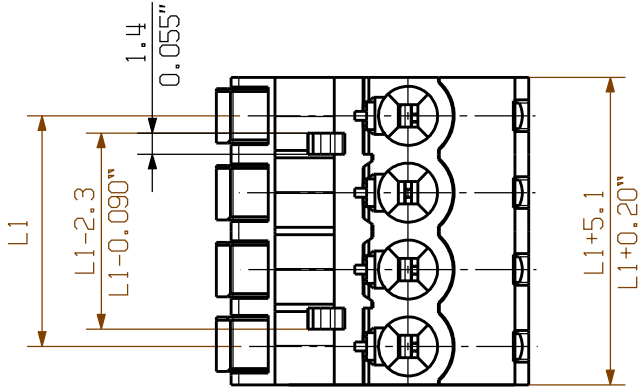

PRINTING AREA  
TOP

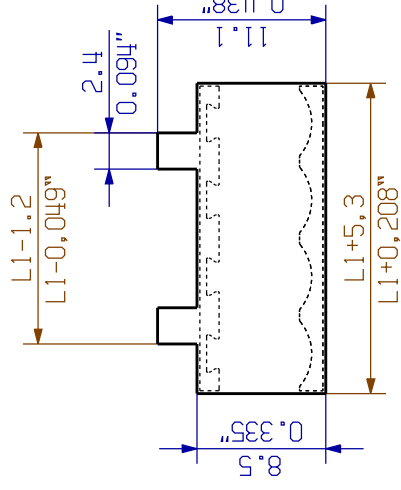
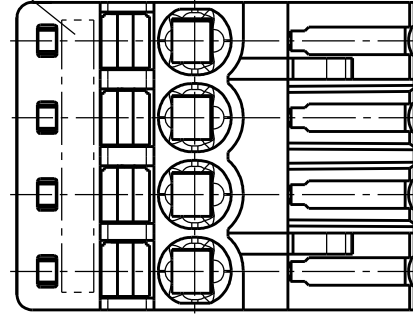

M 1:1

MIN. FRONT PLATE CUT-OUT

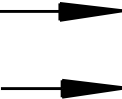

SCHEMATA NUR ZUR ILLUSTRATION GELIEFERT. FÜR WEITERE INFORMATIONEN BITTE MIT UNSEREM VERTRIEBSMANN KONTAKTIEREN.  
SCHEMATA WITHOUT EXPLICIT AUTHORIZATION IS PROHIBITED.  
OR PATENTS, UTILITY MODELS OR DESIGNS.