

MOSFET

OptiMOS™3 Power-Transistor, 80 V

Features

- Ideal for high frequency switching and sync. rec.
- Optimized technology for DC/DC converters
- Excellent gate charge x $R_{DS(on)}$ product (FOM)
- Very low on-resistance $R_{DS(on)}$
- N-channel, normal level
- 100% avalanche tested
- Pb-free plating; RoHS compliant
- Qualified according to JEDEC¹⁾ for target applications
- Halogen-free according to IEC61249-2-21

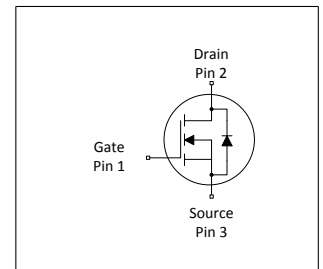

Table 1 Key Performance Parameters

Parameter	Value	Unit
V_{DS}	80	V
$R_{DS(on),max}$	2.8	m Ω
I_D	89	A



Type / Ordering Code	Package	Marking	Related Links
IPA028N08N3 G	PG-TO220-FP	028N08N	-

¹⁾ J-STD20 and JESD22

Table of Contents

Description	1
Maximum ratings	3
Thermal characteristics	3
Electrical characteristics	3
Electrical characteristics diagrams	5
Package Outlines	9
Revision History	10
Trademarks	10
Disclaimer	10

1 Maximum ratings

at $T_A=25\text{ °C}$, unless otherwise specified

Table 2 Maximum ratings

Parameter	Symbol	Values			Unit	Note / Test Condition
		Min.	Typ.	Max.		
Continuous drain current	I_D	-	-	89 62	A	$T_C=25\text{ °C}^{1)}$ $T_C=100\text{ °C}$
Pulsed drain current ²⁾	$I_{D,pulse}$	-	-	352	A	$T_C=25\text{ °C}$
Avalanche energy, single pulse ³⁾	E_{AS}	-	-	1430	mJ	$I_D=89\text{ A}$, $R_{GS}=25\text{ }\Omega$
Gate source voltage	V_{GS}	-20	-	20	V	-
Power dissipation	P_{tot}	-	-	42	W	$T_C=25\text{ °C}$
Operating and storage temperature	T_j , T_{stg}	-55	-	175	°C	IEC climatic category; DIN IEC 68-1: 55/175/56

2 Thermal characteristics

Table 3 Thermal characteristics

Parameter	Symbol	Values			Unit	Note / Test Condition
		Min.	Typ.	Max.		
Thermal resistance, junction - case	R_{thJC}	-	-	3.6	K/W	-

3 Electrical characteristics

Table 4 Static characteristics

Parameter	Symbol	Values			Unit	Note / Test Condition
		Min.	Typ.	Max.		
Drain-source breakdown voltage	$V_{(BR)DSS}$	80	-	-	V	$V_{GS}=0\text{ V}$, $I_D=1\text{ mA}$
Gate threshold voltage	$V_{GS(th)}$	2	2.8	3.5	V	$V_{DS}=V_{GS}$, $I_D=270\text{ }\mu\text{A}$
Zero gate voltage drain current	I_{DSS}	-	0.1 10	1 100	μA	$V_{DS}=80\text{ V}$, $V_{GS}=0\text{ V}$, $T_j=25\text{ °C}$ $V_{DS}=80\text{ V}$, $V_{GS}=0\text{ V}$, $T_j=125\text{ °C}$
Gate-source leakage current	I_{GSS}	-	1	100	nA	$V_{GS}=20\text{ V}$, $V_{DS}=0\text{ V}$
Drain-source on-state resistance	$R_{DS(on)}$	-	2.4 2.8	2.8 4.2	m Ω	$V_{GS}=10\text{ V}$, $I_D=89\text{ A}$ $V_{GS}=6\text{ V}$, $I_D=44\text{ A}$
Gate resistance	R_G	-	2.7	-	Ω	-
Transconductance	g_{fs}	89	178	-	S	$ V_{DS} >2 I_D R_{DS(on)max}$, $I_D=89\text{ A}$

¹⁾ Current is limited by package; with an $R_{thJC}=0.5\text{K/W}$ in a standard TO-220 package the chip is able

²⁾ See Diagram 3 for more detailed information

³⁾ See Diagram 13 for more detailed information

Table 5 Dynamic characteristics

Parameter	Symbol	Values			Unit	Note / Test Condition
		Min.	Typ.	Max.		
Input capacitance	C_{iss}	-	10700	14200	pF	$V_{GS}=0\text{ V}$, $V_{DS}=40\text{ V}$, $f=1\text{ MHz}$
Output capacitance	C_{oss}	-	2890	3840	pF	$V_{GS}=0\text{ V}$, $V_{DS}=40\text{ V}$, $f=1\text{ MHz}$
Reverse transfer capacitance	C_{rss}	-	100	-	pF	$V_{GS}=0\text{ V}$, $V_{DS}=40\text{ V}$, $f=1\text{ MHz}$
Turn-on delay time	$t_{d(on)}$	-	30	-	ns	$V_{DD}=40\text{ V}$, $V_{GS}=10\text{ V}$, $I_D=89\text{ A}$, $R_G=1.6\ \Omega$
Rise time	t_r	-	59	-	ns	$V_{DD}=40\text{ V}$, $V_{GS}=10\text{ V}$, $I_D=89\text{ A}$, $R_G=1.6\ \Omega$
Turn-off delay time	$t_{d(off)}$	-	77	-	ns	$V_{DD}=40\text{ V}$, $V_{GS}=10\text{ V}$, $I_D=89\text{ A}$, $R_G=1.6\ \Omega$
Fall time	t_f	-	26	-	ns	$V_{DD}=40\text{ V}$, $V_{GS}=10\text{ V}$, $I_D=89\text{ A}$, $R_G=1.6\ \Omega$

Table 6 Gate charge characteristics¹⁾

Parameter	Symbol	Values			Unit	Note / Test Condition
		Min.	Typ.	Max.		
Gate to source charge	Q_{gs}	-	50	-	nC	$V_{DD}=40\text{ V}$, $I_D=89\text{ A}$, $V_{GS}=0\text{ to }10\text{ V}$
Gate to drain charge	Q_{gd}	-	30	-	nC	$V_{DD}=40\text{ V}$, $I_D=89\text{ A}$, $V_{GS}=0\text{ to }10\text{ V}$
Switching charge	Q_{sw}	-	50	-	nC	$V_{DD}=40\text{ V}$, $I_D=89\text{ A}$, $V_{GS}=0\text{ to }10\text{ V}$
Gate charge total	Q_g	-	155	206	nC	$V_{DD}=40\text{ V}$, $I_D=89\text{ A}$, $V_{GS}=0\text{ to }10\text{ V}$
Gate plateau voltage	$V_{plateau}$	-	4.6	-	V	$V_{DD}=40\text{ V}$, $I_D=89\text{ A}$, $V_{GS}=0\text{ to }10\text{ V}$
Output charge	Q_{oss}	-	210	279	nC	$V_{DD}=40\text{ V}$, $V_{GS}=0\text{ V}$

Table 7 Reverse diode

Parameter	Symbol	Values			Unit	Note / Test Condition
		Min.	Typ.	Max.		
Diode continuous forward current	I_S	-	-	89	A	$T_C=25\text{ °C}$
Diode pulse current	$I_{S,pulse}$	-	-	356	A	$T_C=25\text{ °C}$
Diode forward voltage	V_{SD}	-	0.9	1.2	V	$V_{GS}=0\text{ V}$, $I_F=89\text{ A}$, $T_J=25\text{ °C}$
Reverse recovery time	t_{rr}	-	78	-	ns	$V_R=40\text{ V}$, $I_F=I_S$, $di_F/dt=100\text{ A}/\mu\text{s}$
Reverse recovery charge	Q_{rr}	-	181	-	nC	$V_R=40\text{ V}$, $I_F=I_S$, $di_F/dt=100\text{ A}/\mu\text{s}$

¹⁾ See "Gate charge waveforms" for parameter definition

4 Electrical characteristics diagrams

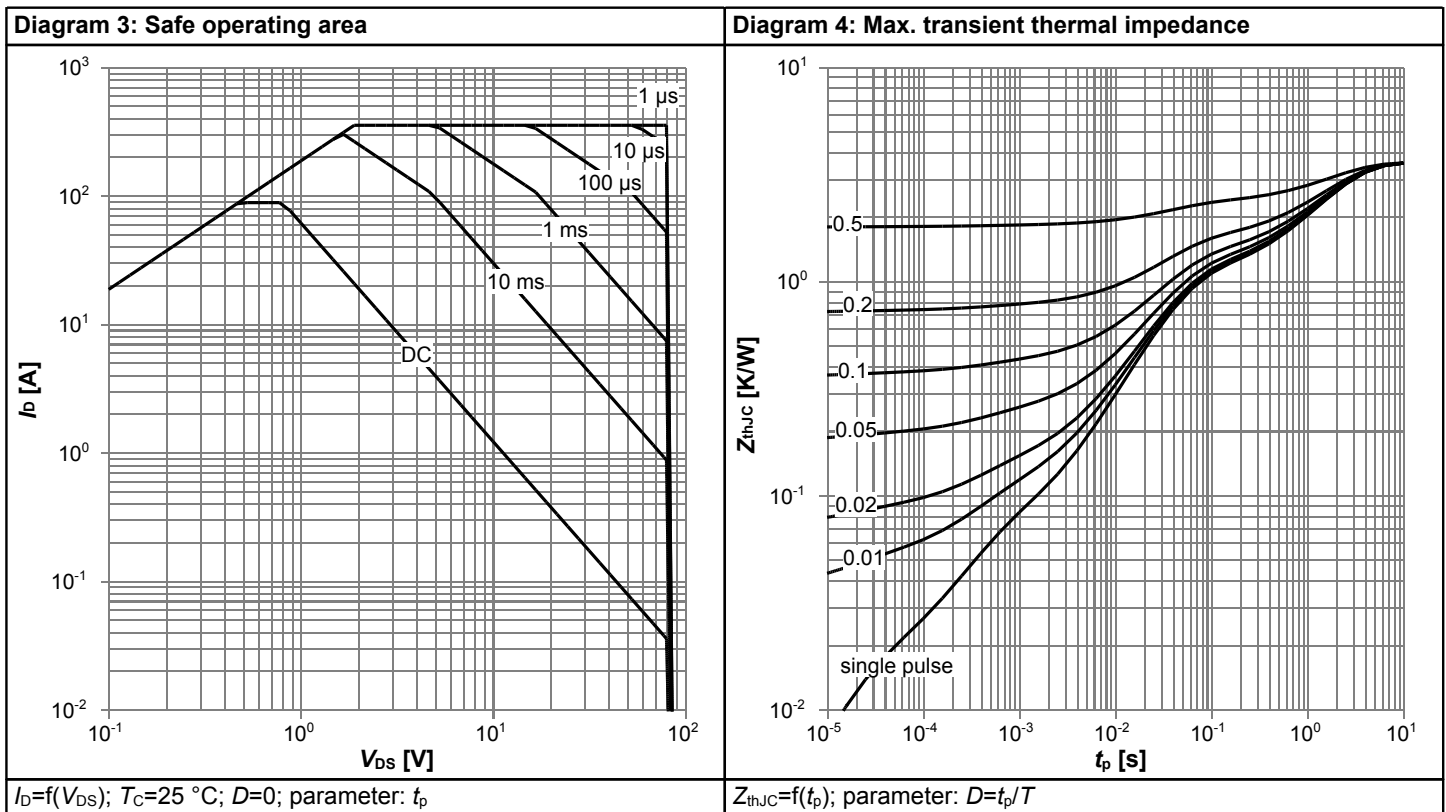
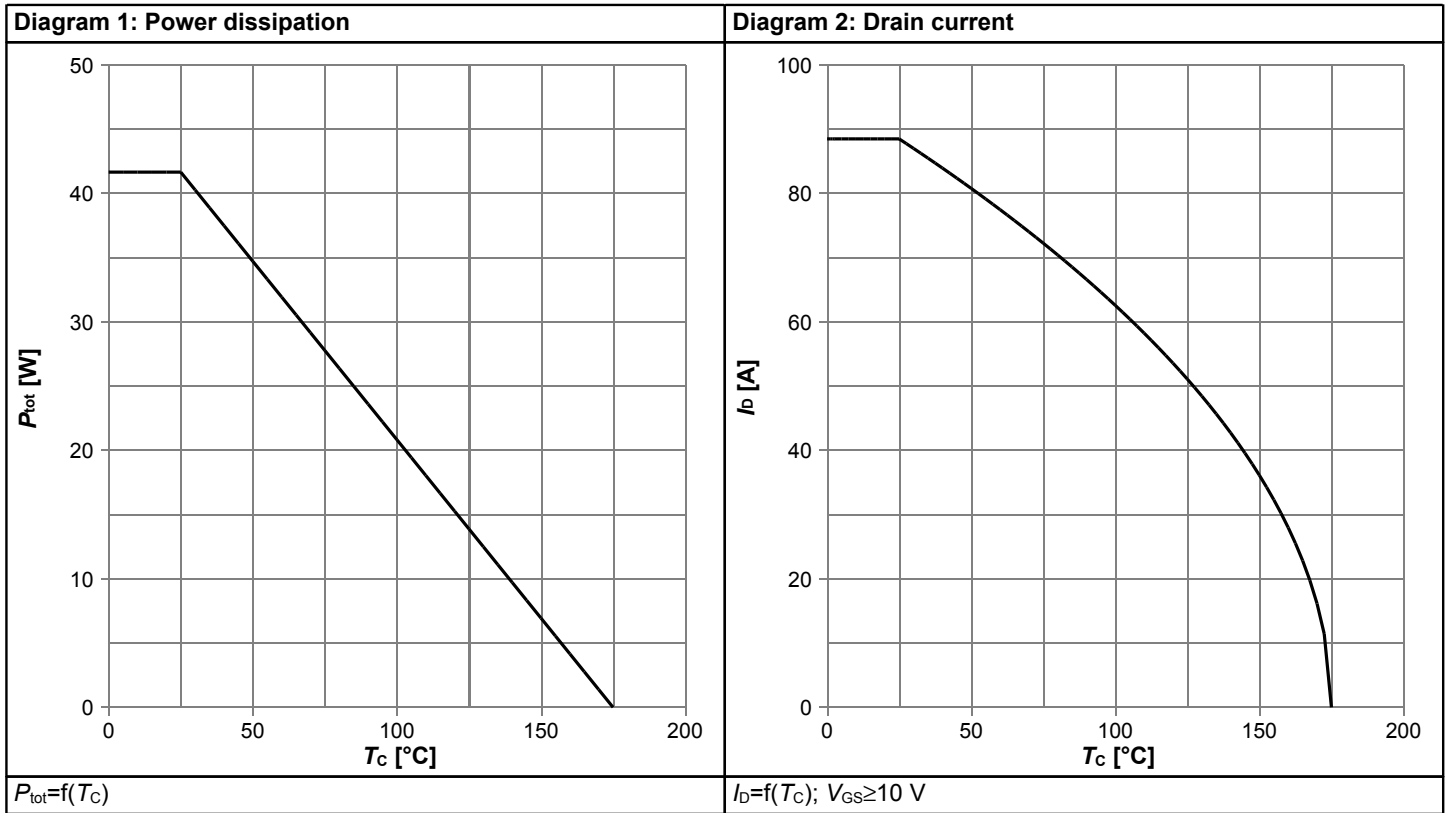
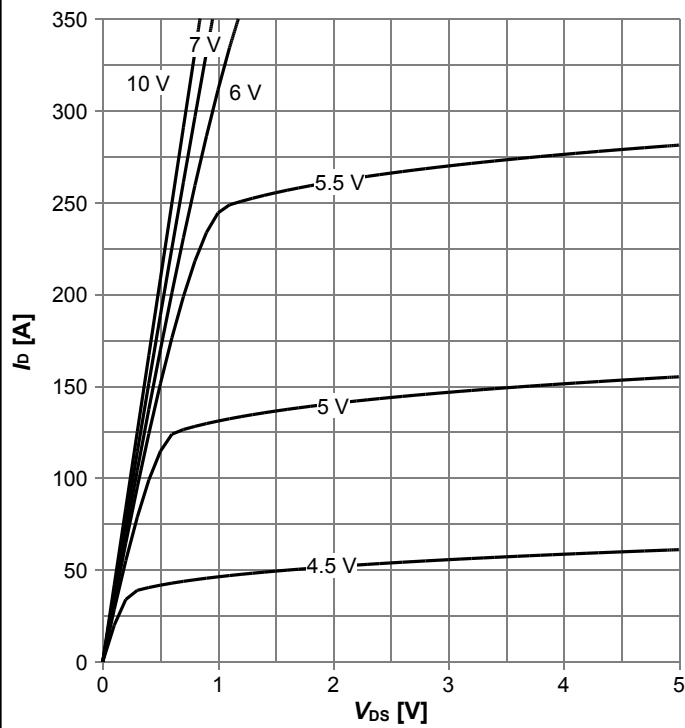
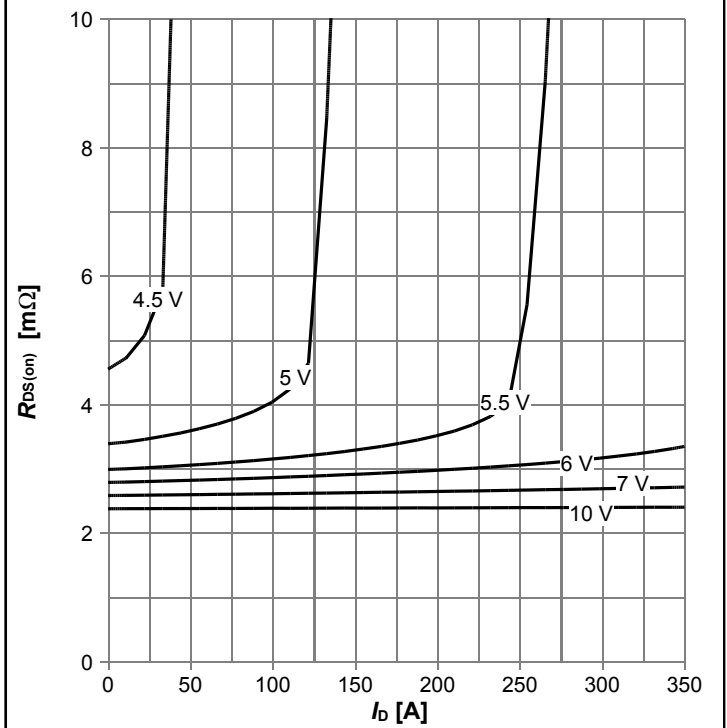

Diagram 5: Typ. output characteristics



$I_D=f(V_{DS}); T_j=25\text{ }^\circ\text{C};$ parameter: V_{GS}

Diagram 6: Typ. drain-source on resistance



$R_{DS(on)}=f(I_D); T_j=25\text{ }^\circ\text{C};$ parameter: V_{GS}

Diagram 7: Typ. transfer characteristics

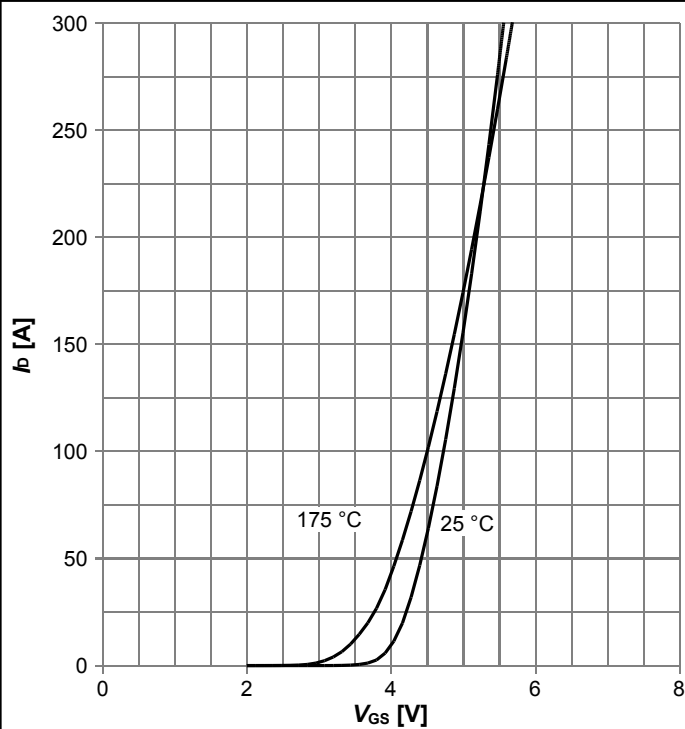

$I_D=f(V_{GS}); |V_{DS}|>2|I_D|R_{DS(on)max};$ parameter: T_j

Diagram 8: Typ. forward transconductance

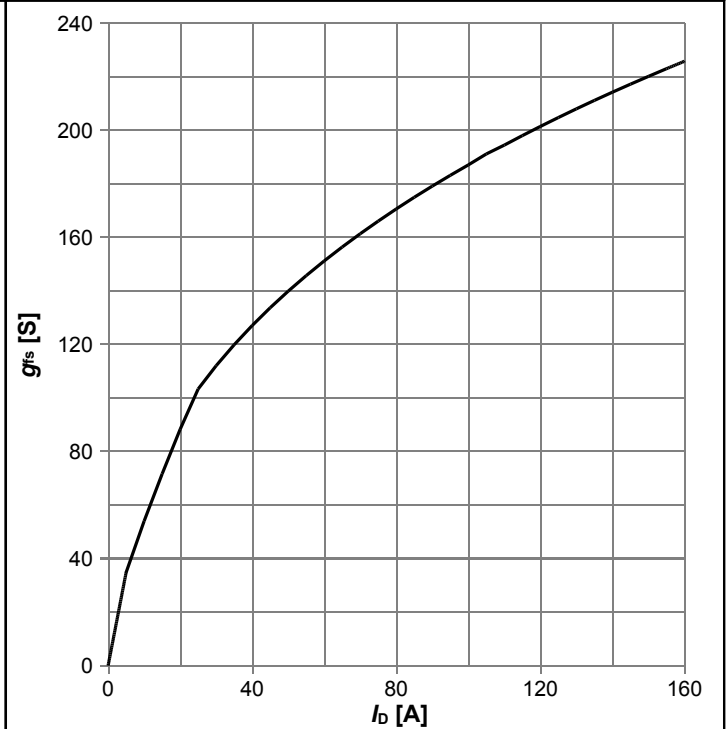

$g_{fs}=f(I_D); T_j=25\text{ }^\circ\text{C}$

Diagram 9: Drain-source on-state resistance

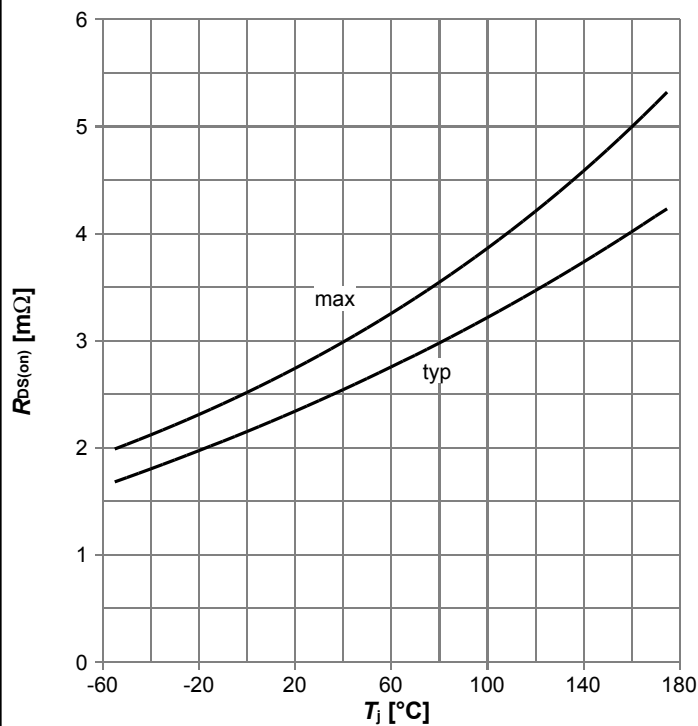

$R_{DS(on)}=f(T_j)$; $I_D=89\text{ A}$; $V_{GS}=10\text{ V}$

Diagram 10: Typ. gate threshold voltage

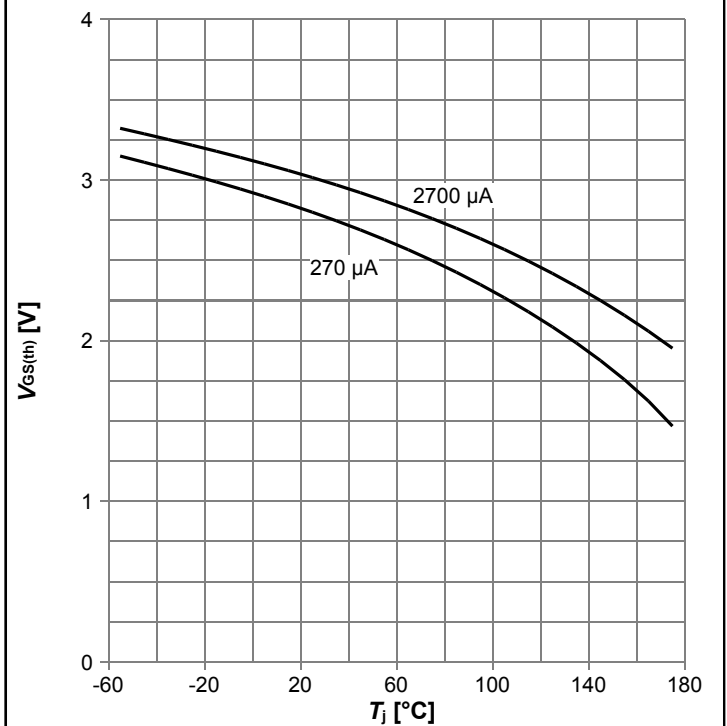

$V_{GS(th)}=f(T_j)$; $V_{GS}=V_{DS}$; parameter: I_D

Diagram 11: Typ. capacitances

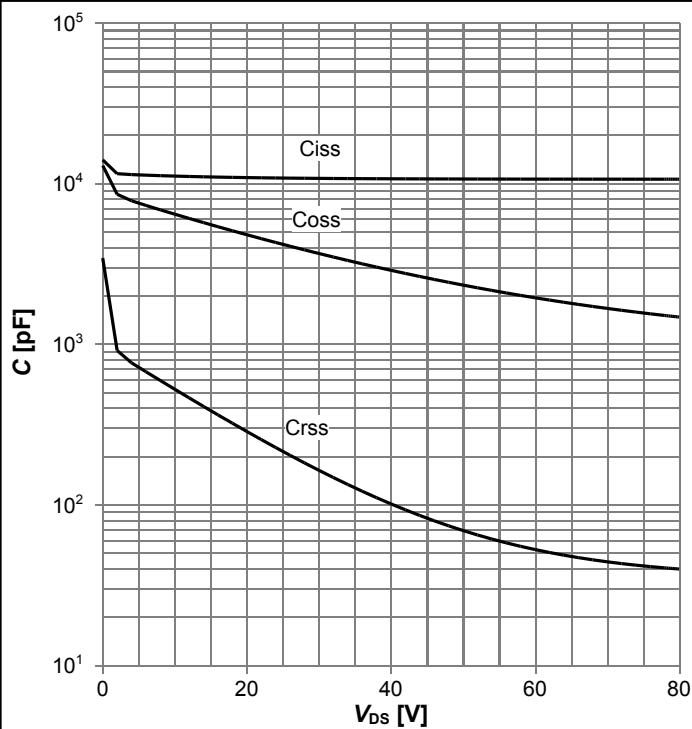

$C=f(V_{DS})$; $V_{GS}=0\text{ V}$; $f=1\text{ MHz}$

Diagram 12: Forward characteristics of reverse diode

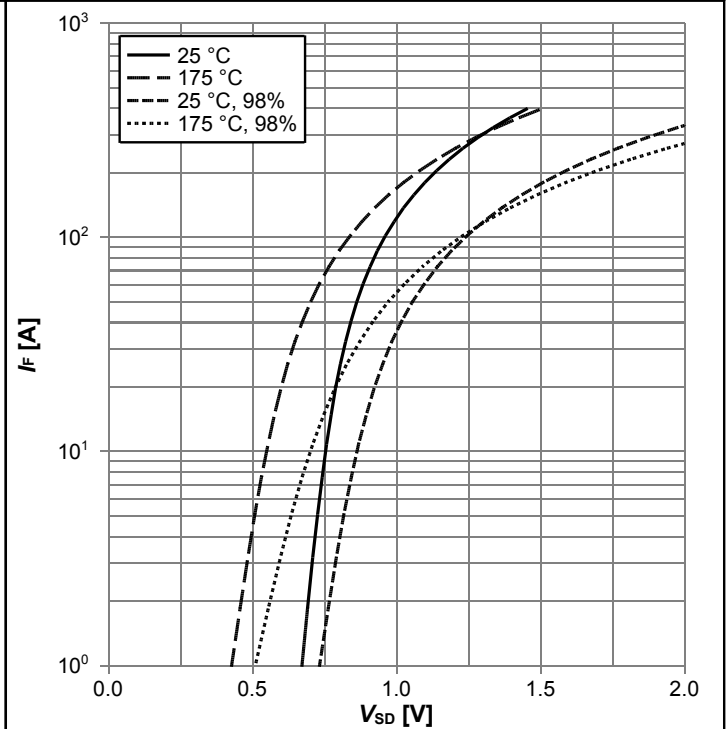

$I_F=f(V_{SD})$; parameter: T_j

Diagram 13: Avalanche characteristics

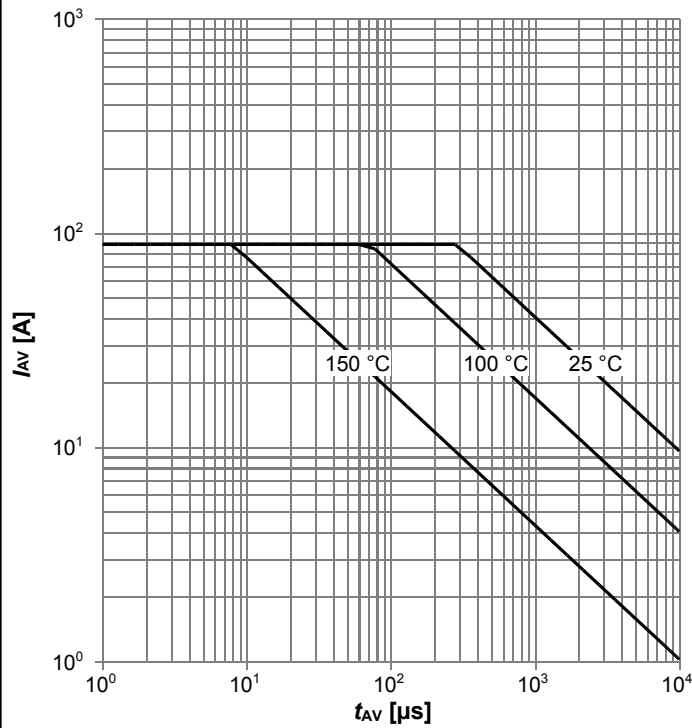

$I_{AS}=f(t_{AV}); R_{GS}=25 \Omega$; parameter: $T_{j(start)}$

Diagram 14: Typ. gate charge

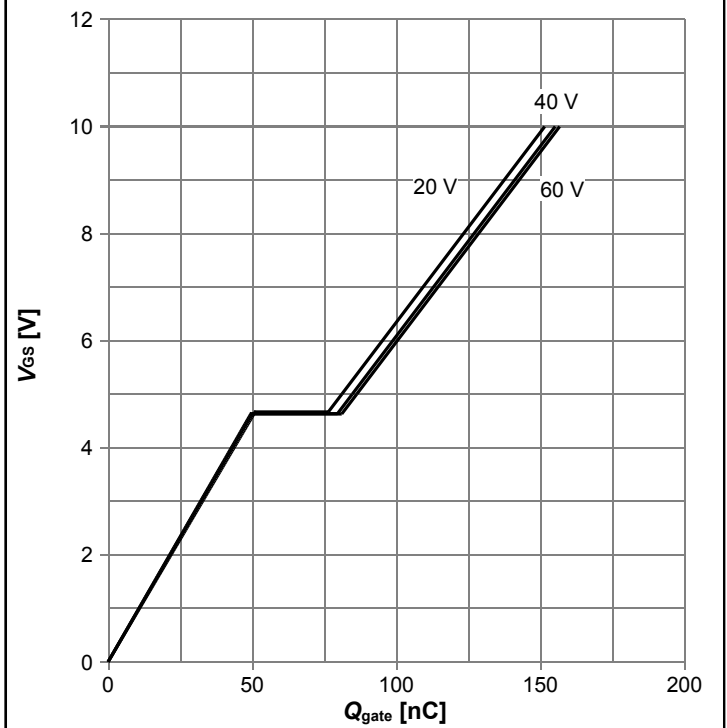

$V_{GS}=f(Q_{gate}); I_D=89A$ pulsed; parameter: V_{DD}

Diagram 15: Drain-source breakdown voltage

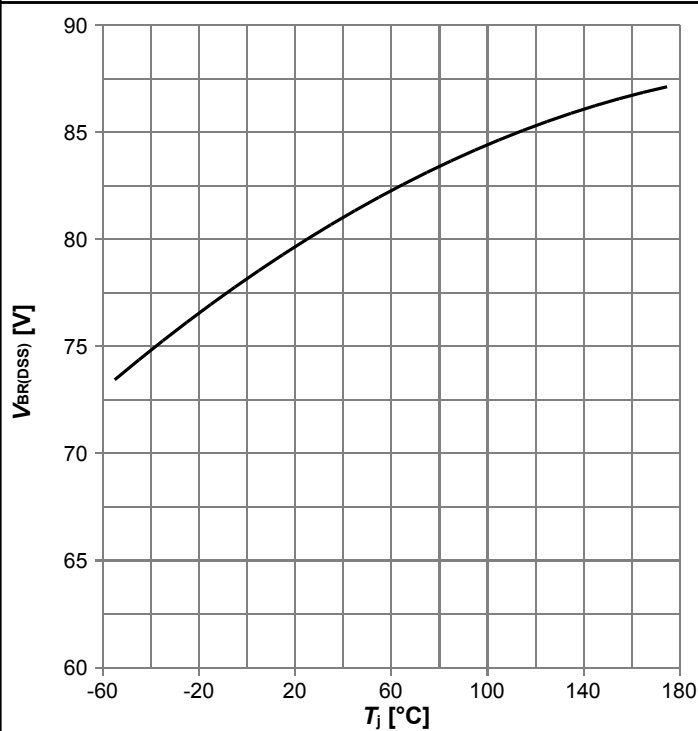

$V_{BR(DSS)}=f(T_j); I_D=1 \text{ mA}$

Gate charge waveforms

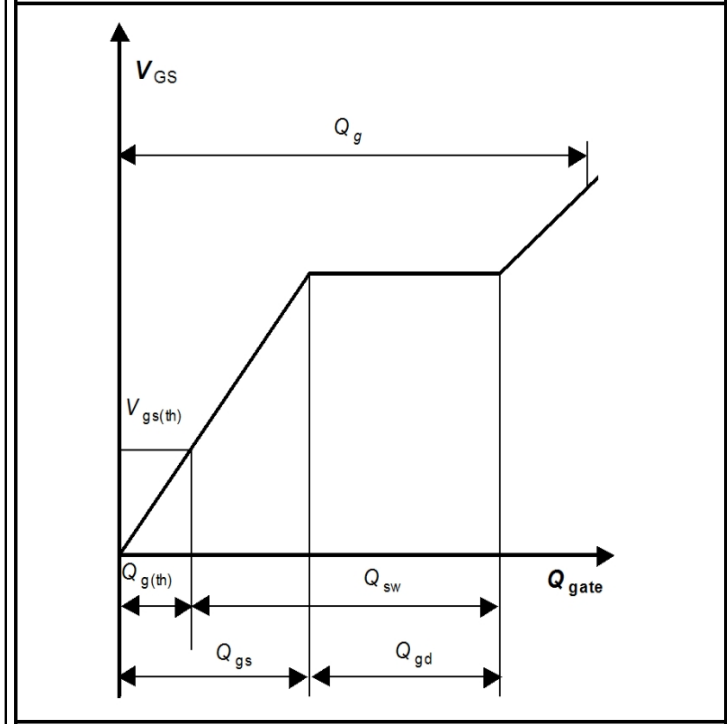

5 Package Outlines

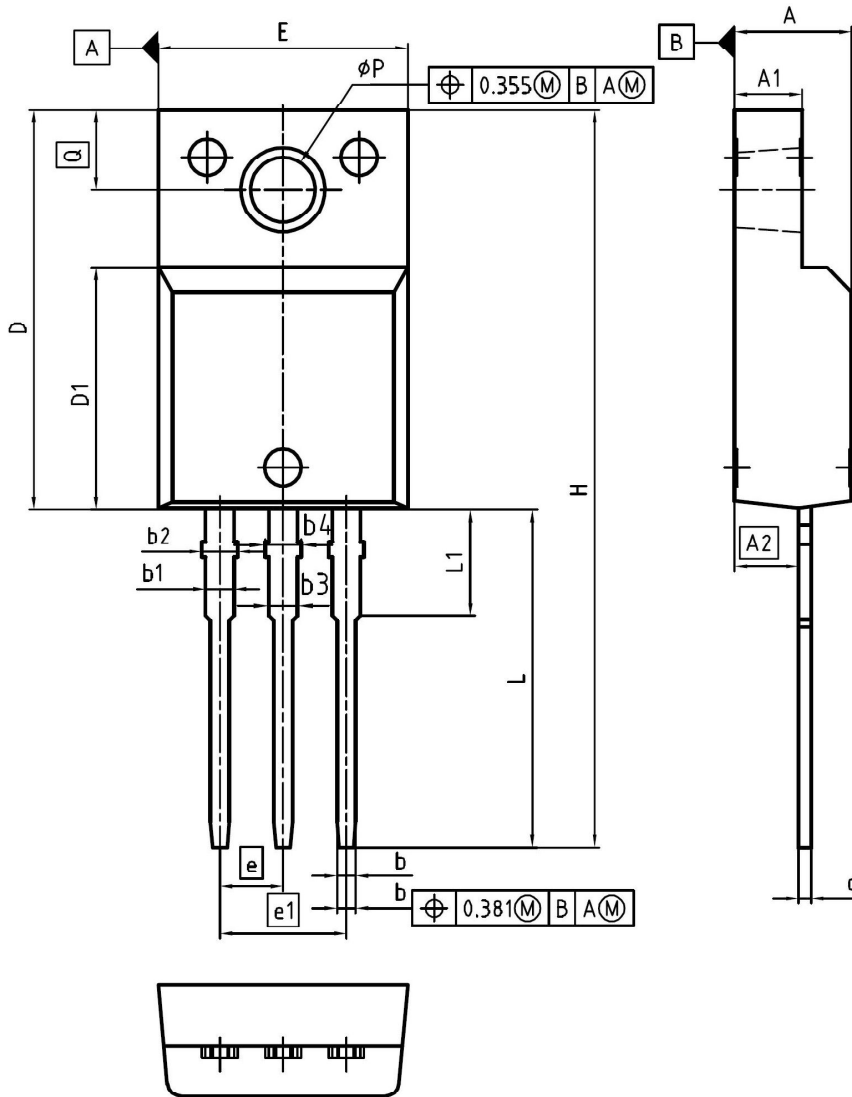

DIM	MILLIMETERS		INCHES	
	MIN	MAX	MIN	MAX
A	4.55	4.85	0.179	0.191
A1	2.55	2.85	0.100	0.112
A2	2.42	2.72	0.095	0.107
b	0.65	0.85	0.026	0.033
b1	0.95	1.33	0.037	0.052
b2	0.95	1.51	0.037	0.059
b3	0.65	1.33	0.026	0.052
b4	0.65	1.51	0.026	0.059
c	0.40	0.63	0.016	0.025
D	15.85	16.15	0.624	0.636
D1	9.53	9.83	0.375	0.387
E	10.35	10.65	0.407	0.419
e	2.54		0.100	
e1	5.08		0.200	
N	3		3	
H	29.45	29.75	1.159	1.171
L	13.45	13.75	0.530	0.541
L1	3.15	3.45	0.124	0.136
øP	2.95	3.20	0.116	0.126
Q	3.15	3.50	0.124	0.138

DOCUMENT NO.
Z8B00003319

SCALE

EUROPEAN PROJECTION

ISSUE DATE
08-03-2007

REVISION
03

Figure 1 Outline PG-TO220-FP, dimensions in mm/inches

Revision History

IPA028N08N3 G

Revision: 2016-06-30, Rev. 2.0

Previous Revision

Revision	Date	Subjects (major changes since last revision)
2.0	2016-06-30	Release of final version

Trademarks of Infineon Technologies AG

AURIX™, C166™, CanPAK™, CIPOS™, CoolGaN™, CoolMOS™, CoolSET™, CoolSiC™, CORECONTROL™, CROSSAVE™, DAVE™, DI-POL™, DrBlade™, EasyPIM™, EconoBRIDGE™, EconoDUAL™, EconoPACK™, EconoPIM™, EiceDRIVER™, eupec™, FCOS™, HITFET™, HybridPACK™, Infineon™, ISOFACE™, IsoPACK™, i-Wafer™, MIPAQ™, ModSTACK™, my-d™, NovalithIC™, OmniTune™, OPTIGA™, OptiMOS™, ORIGA™, POWERCODE™, PRIMARION™, PrimePACK™, PrimeSTACK™, PROFET™, PRO-SIL™, RASIC™, REAL3™, ReverSave™, SatRIC™, SIEGET™, SIPMOS™, SmartLEWIS™, SOLID FLASH™, SPOC™, TEMPFET™, thinQ!™, TRENCHSTOP™, TriCore™.

Trademarks updated August 2015

Other Trademarks

All referenced product or service names and trademarks are the property of their respective owners.

We Listen to Your Comments

Any information within this document that you feel is wrong, unclear or missing at all? Your feedback will help us to continuously improve the quality of this document. Please send your proposal (including a reference to this document) to:

erratum@infineon.com

Published by

Infineon Technologies AG

81726 München, Germany

© 2016 Infineon Technologies AG

All Rights Reserved.

Legal Disclaimer

The information given in this document shall in no event be regarded as a guarantee of conditions or characteristics. With respect to any examples or hints given herein, any typical values stated herein and/or any information regarding the application of the device, Infineon Technologies hereby disclaims any and all warranties and liabilities of any kind, including without limitation, warranties of non-infringement of intellectual property rights of any third party.

Information

For further information on technology, delivery terms and conditions and prices please contact your nearest Infineon Technologies Office (www.infineon.com).

Warnings

Due to technical requirements, components may contain dangerous substances. For information on the types in question, please contact the nearest Infineon Technologies Office.

The Infineon Technologies component described in this Data Sheet may be used in life-support devices or systems and/or automotive, aviation and aerospace applications or systems only with the express written approval of Infineon Technologies, if a failure of such components can reasonably be expected to cause the failure of that life-support, automotive, aviation and aerospace device or system or to affect the safety or effectiveness of that device or system. Life support devices or systems are intended to be implanted in the human body or to support and/or maintain and sustain and/or protect human life. If they fail, it is reasonable to assume that the health of the user or other persons may be endangered.