



HVA 280

TE Internal #: 4-2103015-2

Housing for Female Terminals, Wire-to-Device / Wire-to-Board, 2 Position, .409 in [10.4 mm] Centerline, Sealable, Orange, Wire & Cable, HVA 280

[View on TE.com >](#)

Connectors > Automotive Connectors > Automotive Housings



Connector System: **Wire-to-Board, Wire-to-Device**

Number of Positions: **2**

Connector & Housing Type: **Housing for Female Terminals**

Centerline (Pitch): **10.4 mm [.409 in]**

Sealable: **Yes**

Features

Product Type Features

Mixed & Hybrid Connector	No
Connector Shape	Rectangular
Connector System	Wire-to-Board, Wire-to-Device
Connector & Housing Type	Housing for Female Terminals
Sealable	Yes
Connector & Contact Terminates To	Wire & Cable
Primary Locking Feature	On the Terminal

Configuration Features

Number of Positions	2
Number of Rows	1

Electrical Characteristics

Operating Voltage	850 VDC
Nominal Voltage Architecture	12 V, 24 V, 42 V, 48 V, 80 V, 90 V, 125 V, 240 V, 500 V, 550 V, 600 V

Body Features

Cable Exit Angle	180°
Primary Product Color	Orange
Connector & Keying Code	B



Contact Features

Contact Size	2.8mm
Contact Type	Receptacle
Mating Tab Width	2.8 mm[.11 in]

Mechanical Attachment

Terminal Position Assurance	No
Strain Relief	With
Mating Alignment Type	Keyed
Mating Alignment	With
Connector Mounting Type	Cable Mount (Free-Hanging)

Housing Features

Housing Material	PA GF
Centerline (Pitch)	10.4 mm[.409 in]

Dimensions

Connector Height	27.6 mm[1.087 in]
Product Width	55.3 mm[2.177 in]
Product Length	32.9 mm[1.295 in]

Usage Conditions

Operating Temperature (Max)	70 °C, 75 °C, 80 °C, 85 °C, 90 °C, 100 °C, 105 °C, 110 °C, 120 °C, 125 °C[158 °F][167 °F][176 °F][185 °F][194 °F][212 °F][221 °F][230 °F][248 °F][257 °F]
Operating Temperature Range	-40 – 125 °C[-40 – 257 °F]

Operation/Application

Circuit Application	Signal
---------------------	--------

Industry Standards

Degree of Protection	IP6K9K
UL Flammability Rating	UL 94HB

Packaging Features

Packaging Quantity	1
Packaging Method	Package

Other

Serviceable	Yes
-------------	-----



Connector Position Assurance Capable Yes

Product Compliance

[For compliance documentation, visit the product page on TE.com>](#)















EU RoHS Directive 2011/65/EU	Compliant
EU ELV Directive 2000/53/EC	Compliant
China RoHS 2 Directive MIIT Order No 32, 2016	No Restricted Materials Above Threshold
EU REACH Regulation (EC) No. 1907/2006	Current ECHA Candidate List: JUNE 2023 (235) Candidate List Declared Against: JUNE 2023 (235) Does not contain REACH SVHC
Halogen Content	Low Halogen - Br, Cl, F, I < 900 ppm per homogenous material. Also BFR/CFR/PVC Free
Solder Process Capability	Not reviewed for solder process capability

Product Compliance Disclaimer



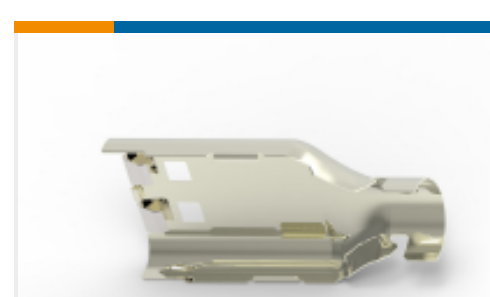

This information is provided based on reasonable inquiry of our suppliers and represents our current actual knowledge based on the information they provided. This information is subject to change. The part numbers that TE has identified as EU RoHS compliant have a maximum concentration of 0.1% by weight in homogenous materials for lead, hexavalent chromium, mercury, PBB, PBDE, DBP, BBP, DEHP, DIBP, and 0.01% for cadmium, or qualify for an exemption to these limits as defined in the Annexes of Directive 2011/65/EU (RoHS2). Finished electrical and electronic equipment products will be CE marked as required by Directive 2011/65/EU. Components may not be CE marked. Additionally, the part numbers that TE has identified as EU ELV compliant have a maximum concentration of 0.1% by weight in homogenous materials for lead, hexavalent chromium, and mercury, and 0.01% for cadmium, or qualify for an exemption to these limits as defined in the Annexes of Directive 2000/53/EC (ELV). Regarding the REACH Regulation, the information TE provides on SVHC in articles for this part number is based on the latest European Chemicals Agency (ECHA) 'Guidance on requirements for substances in articles' posted at this URL: <https://echa.europa.eu/guidance-documents/guidance-on-reach>

Compatible Parts

 <p>TE Part # 1587723-2 INNER FERRULE, SIZE B, HVA280-</p>	 <p>TE Part # 1587724-2 OUTER FERRULE, SIZE B, HVA280</p>	 <p>TE Part # 2103013-1 CABLE SEAL RETAINER, SIZE 1, HVA280</p>	 <p>TE Part # 1-2103157-2 SHIELD, PLUG, SIZE 2, Ag, HVA280</p>
---	--	--	---

 <p>TE Part # 1587724-3 OUTER FERRULE, SIZE C, HVA280</p>	 <p>TE Part # 1587985-1 INNER HSG SUBASSY, HVA280-2PHM</p>	 <p>TE Part # 1587723-3 INNER FERRULE, SIZE C, HVA280</p>	 <p>TE Part # 2103153-1 SPACER, HVA280-2PHM</p>
 <p>TE Part # 1587724-1 OUTER FERRULE, SIZE A, HVA280</p>	 <p>TE Part # 1587723-1 INNER FERRULE, SIZE A, HVA280</p>	 <p>TE Part # 2103157-1 SHIELD, PLUG, SIZE 1, Sn, HVA280</p>	 <p>TE Part # 2103306-1 INNER HOUSING, PLUG, HVA280-3PXM, XE</p>
 <p>TE Part # 2103188-2 CABLE SEAL, SIZE B, HVA280-3PM</p>	 <p>TE Part # 1587977-2 INNER HOUSING, PLUG, HVA280-2PHM, PASS T</p>	 <p>TE Part # 2103154-2 CABLE SEAL, SIZE 2, HVA280</p>	 <p>TE Part # 2103154-1 CABLE SEAL, SIZE 1, HVA280</p>
 <p>TE Part # 2103155-1 COLLET, SIZE 1, HVA280</p>	 <p>TE Part # 1-2103157-1 SHIELD, PLUG, SIZE 1, Ag, HVA280</p>	 <p>TE Part # 2103013-2 CABLE SEAL RETAINER, SIZE 2, BK, HVA280</p>	 <p>TE Part # 2103013-3 CABLE SEAL RETAINER, SIZE 2, OR, HVA280</p>

Also in the Series | **HVA 280**

 <p>Automotive Connector Caps & Covers (5)</p>	 <p>Automotive Connector EMC Shielding (15)</p>	 <p>Automotive Housings(70)</p>	 <p>Connector Seals & Cavity Plugs(8)</p>
---	--	--	--



High Voltage Wire Processing Equipment(7)

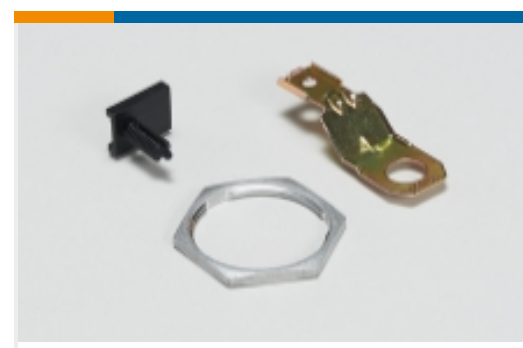

Other Automotive Connector Accessories(39)

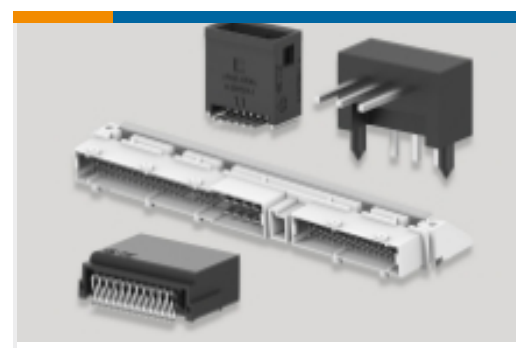

PCB Headers & Receptacles(37)

Customers Also Bought

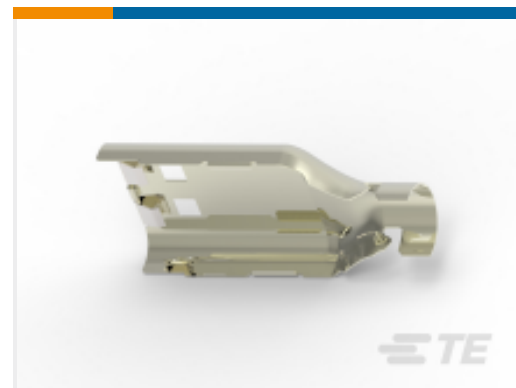
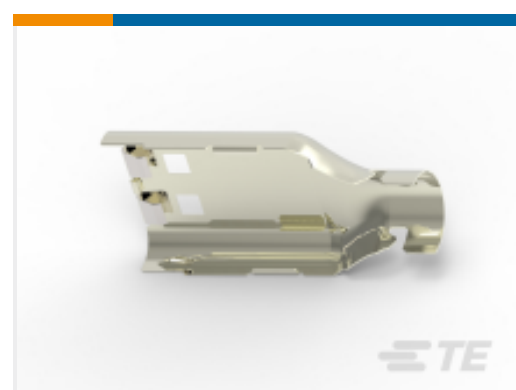
TE Part #1587723-2
INNER FERRULE, SIZE B, HVA280-TE Part #1587724-2
OUTER FERRULE, SIZE B, HVA280TE Part #1-2103157-2
SHIELD, PLUG, SIZE 2, Ag, HVA280TE Part #1-968853-3
AMP MCP 2.8, CONTACTTE Part #4-2103015-4
PLUG SUBASSY, D, HVA280-2PHM FTE Part #2103306-1
INNER HOUSING, PLUG, HVA280-3PXM, XETE Part #1-2103157-1
SHIELD, PLUG, SIZE 1, Ag, HVA280TE Part #2103155-2
COLLET, SIZE 2, HVA280TE Part #9-2177810-1
PIN DIA 6.0, L/N, ASSYTE Part #9465854003
RNF-3000-NR552-0-SP

Documents

Product Drawings

[PLUG SUBASSY, B, HVA280-2PHM F](#)

English

CAD Files

[Customer View Model](#)

[ENG_CVM_CVM_4-2103015-2_A.2d_dxf.zip](#)

English

[3D PDF](#)



3D

Customer View Model

[ENG_CVM_CVM_4-2103015-2_A.3d_igs.zip](#)

English

Customer View Model

[ENG_CVM_CVM_4-2103015-2_A.3d_stp.zip](#)

English

By downloading the CAD file I accept and agree to the [Terms and Conditions](#) of use.

Product Specifications

[Application Specification](#)

English

[Application Specification](#)

English

[Application Specification](#)

English