

184060-1 ✓ ACTIVE

AMP | Sealed Sensor Connector SSC System

TE Internal #: 184060-1

Housing for Female Terminals, Wire-to-Device / Wire-to-Wire / Wire-to-Board, 6 Position, .197 in [5 mm] Centerline, Sealed Sensor Connector SSC System

[View on TE.com >](#)



Connectors > Automotive Connectors > Automotive Housings

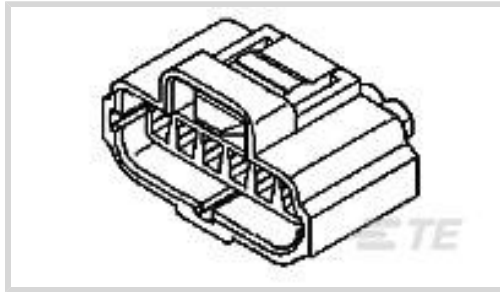

Connector System: **Wire-to-Board, Wire-to-Device, Wire-to-Wire**

Number of Positions: **6**

Connector & Housing Type: **Housing for Female Terminals**

Centerline (Pitch): **5 mm [.197 in]**

Sealable: **Yes**

Features

Product Type Features

Mixed & Hybrid Connector	No
Connector Shape	Rectangular
Connector System	Wire-to-Board, Wire-to-Device, Wire-to-Wire
Connector & Housing Type	Housing for Female Terminals
Sealable	Yes
Primary Locking Feature	Integrated in Housing

Configuration Features

Number of Positions	6
Number of Rows	1

Electrical Characteristics

Operating Voltage	125 VAC
Nominal Voltage Architecture	12 V, 24 V, 42 V, 48 V, 80 V, 90 V, 125 V

Body Features

Cable Exit Angle	180°
Primary Product Color	Black
Connector & Keying Code	A

Contact Features

--	--

Contact Size	1.8mm
--------------	-------

Mechanical Attachment

Terminal Position Assurance	No
-----------------------------	----

Strain Relief	Without
---------------	---------

Mating Alignment Type	Keyed
-----------------------	-------

Mating Alignment	With
------------------	------

Connector Mounting Type	Cable Mount (Free-Hanging)
-------------------------	----------------------------

Housing Features

Housing Material	PA GF
------------------	-------

Centerline (Pitch)	5 mm [.197 in]
--------------------	----------------

Dimensions

Connector Height	24.8 mm [.98 in]
------------------	------------------

Product Width	27.6 mm [1.087 in]
---------------	--------------------

Product Length	43.2 mm [1.7 in]
----------------	------------------

Usage Conditions

Operating Temperature (Max)	70 °C, 75 °C, 80 °C, 85 °C, 90 °C, 100 °C, 105 °C, 110 °C, 120 °C, 125 °C [158 °F][167 °F][176 °F][185 °F][194 °F][212 °F][221 °F][230 °F][248 °F][257 °F]
-----------------------------	--

Operating Temperature Range	-40 – 125 °C [-40 – 257 °F]
-----------------------------	-----------------------------

Industry Standards

UL Flammability Rating	UL 94HB
------------------------	---------

Packaging Features

Packaging Quantity	800
--------------------	-----

Packaging Method	Package
------------------	---------

Other

Serviceable	Yes
-------------	-----

Connector Position Assurance Capable	No
--------------------------------------	----

Product Compliance

[For compliance documentation, visit the product page on TE.com>](#)

EU RoHS Directive 2011/65/EU	Compliant
------------------------------	-----------

EU ELV Directive 2000/53/EC	Compliant
-----------------------------	-----------

China RoHS 2 Directive MIIT Order No 32, 2016

No Restricted Materials Above Threshold

EU REACH Regulation (EC) No. 1907/2006

Current ECHA Candidate List: JUNE 2023 (235)

Candidate List Declared Against: JUNE 2023 (235)

Does not contain REACH SVHC

Halogen Content

Low Halogen - Br, Cl, F, I < 900 ppm per homogenous material. Also BFR/CFR/PVC Free

Solder Process Capability

Not reviewed for solder process capability

Product Compliance Disclaimer

This information is provided based on reasonable inquiry of our suppliers and represents our current actual knowledge based on the information they provided. This information is subject to change. The part numbers that TE has identified as EU RoHS compliant have a maximum concentration of 0.1% by weight in homogenous materials for lead, hexavalent chromium, mercury, PBB, PBDE, DBP, BBP, DEHP, DIBP, and 0.01% for cadmium, or qualify for an exemption to these limits as defined in the Annexes of Directive 2011/65/EU (RoHS2). Finished electrical and electronic equipment products will be CE marked as required by Directive 2011/65/EU. Components may not be CE marked. Additionally, the part numbers that TE has identified as EU ELV compliant have a maximum concentration of 0.1% by weight in homogenous materials for lead, hexavalent chromium, and mercury, and 0.01% for cadmium, or qualify for an exemption to these limits as defined in the Annexes of Directive 2000/53/EC (ELV). Regarding the REACH Regulation, the information TE provides on SVHC in articles for this part number is based on the latest European Chemicals Agency (ECHA) 'Guidance on requirements for substances in articles' posted at this URL: <https://echa.europa.eu/guidance-documents/guidance-on-reach>

Compatible Parts



TE Part # 184006-1
2 POS. PLUG ASSY, KEY D, GREEN



TE Part # 184141-1
WIRE SEAL,RUBBER,SENSOR,PURPLE, LIM



TE Part # 184140-1
WIRE SEAL,RUBBER,SENSOR, ORANGE



TE Part # CAT-EC7491-T273
Econoseal Receptacles and Tabs



TE Part # 171631-2
070 TAB CONT GOLD



TE Part # 184006-2
2 POS. PLUG ASSY, KEY D, GRAY



TE Part # 184166-1
2 POS. CAP HSG., KEY D









TE Part # 184163-1
2 POS. CAP HSG., KEY A

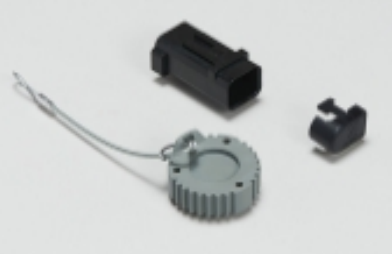
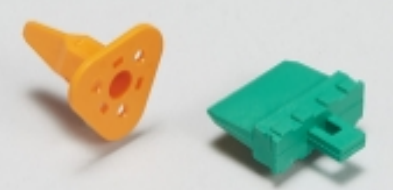

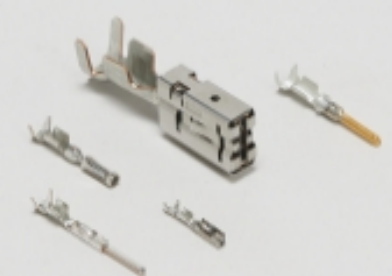
 <p>TE Part # 184207-1 2 POS. PLUG ASSY, KEY J</p>	 <p>TE Part # 184164-1 2 POS. CAP HSG., KEY B</p>	 <p>TE Part # 184004-1 2 POS. PLUG ASSY, KEY C, BLACK</p>	 <p>TE Part # 184165-1 2 POS. CAP HSG., KEY C</p>
 <p>TE Part # 184022-1 2 POS. PLUG ASSY, KEY M, BLACK</p>	 <p>TE Part # 184175-1 2 POS. CAP LP</p>	 <p>TE Part # 184000-1 2 POS. PLUG ASSY, KEY A, BLACK</p>	 <p>TE Part # 184012-1 2 POS. PLUG ASSY, KEY G, GRAY</p>
 <p>TE Part # 184030-3 RECPT, CONTACT 070, PTPPHBZ</p>	 <p>TE Part # 184002-1 2 POS. PLUG ASSY, KEY B, GRAY</p>	 <p>TE Part # 184452-1 6 POS SSC PLUG ASSY, BLKD CKTS</p>	 <p>TE Part # 184030-1 RECPT, CONTACT 070, AUPHBZ</p>

Also in the Series | Sealed Sensor Connector SSC System

 <p>Automotive Connector Caps & Covers (5)</p>	 <p>Automotive Connector Locks & Position Assurance (5)</p>	 <p>Automotive Housings (144)</p>	 <p>Automotive Terminals (6)</p>
 <p>Connector Seals & Cavity Plugs (3)</p>	 <p>Insertion & Extraction Tools (1)</p>	 <p>Other Automotive Connector Accessories (2)</p>	

Customers Also Bought



TE Part #1379217-1
5POS MIXED MOS REC COD Z

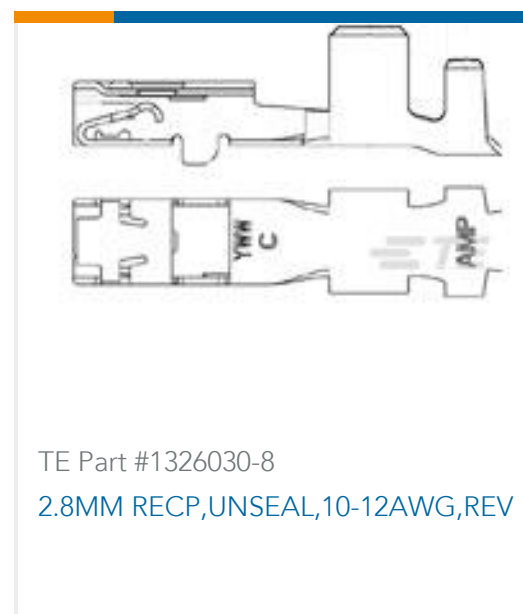

TE Part #1326030-8
2.8MM RECP,UNSEAL,10-12AWG,REV



TE Part #1418844-3
MCON 1.2 CB REC SWS AG



TE Part #1393364-2
V23540X7000Y 12=GET FEM TERM A



TE Part #1563126-1
2. LOCK,10 POS MALE HOUSING



TE Part #1456968-3
CONTACT,FEMALE, 0.64, 20 TO 22
AWG, AG



TE Part #1456968-8
CONTACT,FEMALE, 0.64, 0.35SQMM,
AG, DIR

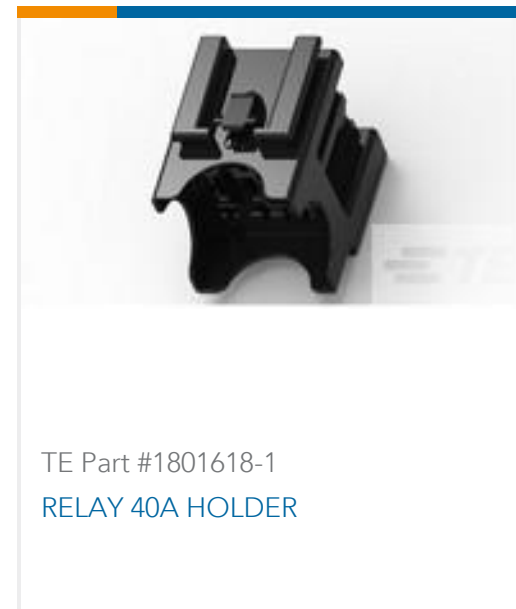

TE Part #1801618-1
RELAY 40A HOLDER



TE Part #1939938-1
0.50/1.0 SEALED PLUG ASSY 60POS

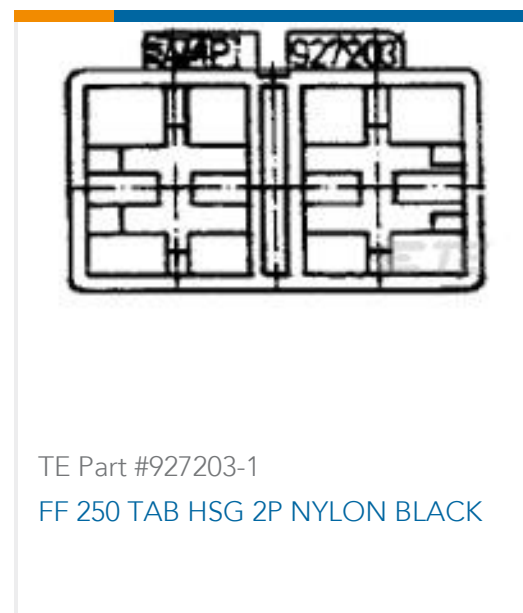

TE Part #927203-1
FF 250 TAB HSG 2P NYLON BLACK

Documents

Product Drawings

[6 POS./6 CIRC PLUG ASSY, KEY A](#)

English

CAD Files

[3D PDF](#)

English

Customer View Model

[ENG_CVM_184060-1_C.2d_dxf.zip](#)

English

Customer View Model

[ENG_CVM_184060-1_C.3d_igs.zip](#)

English

Customer View Model

[ENG_CVM_184060-1_C.3d_stp.zip](#)

English

By downloading the CAD file I accept and agree to the [Terms and Conditions](#) of use.

Product Specifications



Application Specification

English

Instruction Sheets

Instruction Sheet (U.S.)

English

Positioning the Double Lock Plate

English