

1-967241-1 ✓ ACTIVE

AMP | Junior Power Timer

TE Internal #: 1-967241-1

Housing for Female Terminals, Wire-to-Board / Wire-to-Wire, 6 Position, .197 in [5 mm] Centerline, Black, Wire & Cable, Power, Junior Power Timer

[View on TE.com >](#)



Connectors > Automotive Connectors > Automotive Housings > Timer Connector Housing



Connector System: **Wire-to-Board, Wire-to-Wire**

Number of Positions: **6**

Connector & Housing Type: **Housing for Female Terminals**

Centerline (Pitch): **5 mm [.197 in]**

Sealable: **No**

[All Timer Connector Housing \(525\)](#)

Features

Product Type Features

Mixed & Hybrid Connector	No
Connector Shape	Rectangular
Connector System	Wire-to-Board, Wire-to-Wire
Connector & Housing Type	Housing for Female Terminals
Sealable	No
Connector & Contact Terminates To	Wire & Cable
Primary Locking Feature	Integrated in Housing

Configuration Features

Number of Positions	6
Number of Rows	2

Electrical Characteristics

Nominal Voltage Architecture	12 V
------------------------------	------

Body Features

Primary Product Color	Black
Connector & Keying Code	A1

Contact Features

--	--



Contact Size	2.8mm
Contact Type	Receptacle
Mating Tab Width	2.8 mm[.11 in]
Contact Current Rating (Max)	30 A

Mechanical Attachment

Terminal Position Assurance	No
Strain Relief	Without
Mating Alignment Type	Keyed
Mating Alignment	With
Connector Mounting Type	Cable Mount (Free-Hanging)

Housing Features

Housing Material	PBT GF
Centerline (Pitch)	5 mm[.197 in]

Dimensions

Connector Height	37.75 mm[1.486 in]
Product Width	26.3 mm[1.035 in]
Product Length	34.6 mm[1.362 in]
Row-to-Row Spacing	6 mm[.236 in]

Operation/Application

Circuit Application	Power
---------------------	-------

Packaging Features

Packaging Method	Box
------------------	-----

Other

Serviceable	No
Connector Position Assurance Capable	No

Product Compliance

[For compliance documentation, visit the product page on TE.com>](#)

EU RoHS Directive 2011/65/EU	Compliant
EU ELV Directive 2000/53/EC	Compliant
China RoHS 2 Directive MIIT Order No 32, 2016	No Restricted Materials Above Threshold
EU REACH Regulation (EC) No. 1907/2006	



Current ECHA Candidate List: JUNE 2023 (235)
 Candidate List Declared Against: JUNE 2023 (235)
 Does not contain REACH SVHC







Halogen Content
 BFR/CFR/PVC Free, but Br/Cl >900 ppm in other sources.

Solder Process Capability
 Not applicable for solder process capability

Product Compliance Disclaimer

This information is provided based on reasonable inquiry of our suppliers and represents our current actual knowledge based on the information they provided. This information is subject to change. The part numbers that TE has identified as EU RoHS compliant have a maximum concentration of 0.1% by weight in homogenous materials for lead, hexavalent chromium, mercury, PBB, PBDE, DBP, BBP, DEHP, DIBP, and 0.01% for cadmium, or qualify for an exemption to these limits as defined in the Annexes of Directive 2011/65/EU (RoHS2). Finished electrical and electronic equipment products will be CE marked as required by Directive 2011/65/EU. Components may not be CE marked. Additionally, the part numbers that TE has identified as EU ELV compliant have a maximum concentration of 0.1% by weight in homogenous materials for lead, hexavalent chromium, and mercury, and 0.01% for cadmium, or qualify for an exemption to these limits as defined in the Annexes of Directive 2000/53/EC (ELV). Regarding the REACH Regulation, the information TE provides on SVHC in articles for this part number is based on the latest European Chemicals Agency (ECHA) 'Guidance on requirements for substances in articles' posted at this URL: <https://echa.europa.eu/guidance-documents/guidance-on-reach>

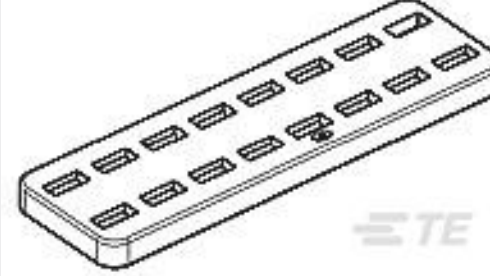
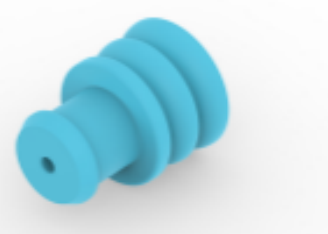
Compatible Parts

 <p>TE Part # CAT-LMPH9507 Low & Medium Power Header</p>	 <p>TE Part # 828922-1 2,5MM CAVITY PLUG FOR 5,4MM DI</p>	 <p>TE Part # 828905-1 SINGLE-WIRE-SEAL(5MM HOLE)</p>	 <p>TE Part # 1-965426-1 FLACHSTE-GEH2,8 6P</p>
 <p>TE Part # CAT-T4827-T273 TIMER, RECEPTACLE AND TAB</p>	 <p>TE Part # 963205-1 SEAL</p>	 <p>TE Part # 828904-1 SINGLE WIRE SEAL FOR J.P.T.CON</p>	 <p>TE Part # 962351-1 SCHIEBER F6P JPT-GH</p>

Also in the Series | [Junior Power Timer](#)



Automotive Connector Caps & Covers (4)



Automotive Housings(231)



Automotive Terminals(82)



Busbars & Terminals(1)



Connector Seals & Cavity Plugs(9)



Insertion & Extraction Tools(8)



Module Components(3)



Other Automotive Connector Accessories(1)

Customers Also Bought



TE Part #1-964449-1
Timer Connector Housing



TE Part #HDP26-24-19PE-L015
PLG, 19P, BLK, E, THD, 12/16, P

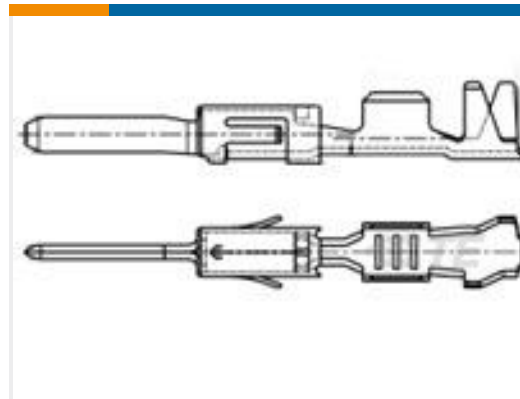

TE Part #963904-2
TAB A 1.6x0.6 CONTACT CF SWS Sn

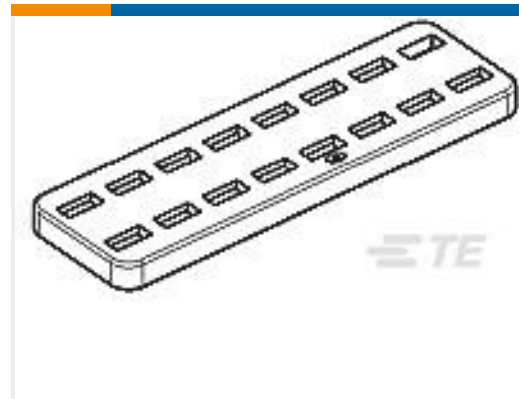

TE Part #963216-1
DICHTUNG



TE Part #2137211-1
4P SPLASH PROOF CONNECTOR, ASS

Documents

Product Drawings

J-P-T HOUSING ASSY 6P

English

CAD Files

3D PDF

English

Customer View Model

ENG_CVM_1-967241-1_B1.2d_dxf.zip



English

Customer View Model

[ENG_CVM_1-967241-1_B1.3d_igs.zip](#)

English

Customer View Model

[ENG_CVM_1-967241-1_B1.3d_stp.zip](#)

English

By downloading the CAD file I accept and agree to the [Terms and Conditions](#) of use.

Datasheets & Catalog Pages

[Timer Interconnection System](#)

English

Instruction Sheets

[CONNECTEURS JPT ETANCHES A ETRIER POUR CONNEXIONS FIL A FIL PRECONISAT](#)

English

[Instruction Sheet \(non U.S.\)](#)

English