

1411001-1 ✓ ACTIVE

[Get .64 Connector System](#)

TE Internal #: 1411001-1

Housing for Female Terminals, Wire-to-Device / Wire-to-Board / Wire-to-Wire, 8 Position, .1 in [2.54 mm] Centerline, Get .64 Connector System

[View on TE.com >](#)



Connectors > Automotive Connectors > Automotive Housings > GET .64 CONNECTOR SYSTEM, CONNECTOR HSG

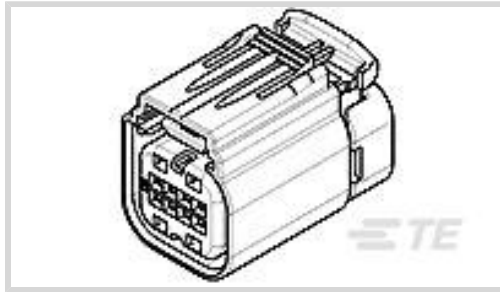

Connector System: **Wire-to-Board, Wire-to-Device, Wire-to-Wire**

Number of Positions: **8**

Connector & Housing Type: **Housing for Female Terminals**

Centerline (Pitch): **2.54 mm [ .1 in ]**

Sealable: **Yes**

[All GET .64 CONNECTOR SYSTEM, CONNECTOR HSG \(85\)](#)

## Features

### Product Type Features

Mixed & Hybrid Connector	No
Connector Shape	Rectangular
Connector System	Wire-to-Board, Wire-to-Device, Wire-to-Wire
Connector & Housing Type	Housing for Female Terminals
Sealable	Yes
Primary Locking Feature	Integrated in Housing

### Configuration Features

Blank Cavity Position	4, 8
Number of Positions	8
Number of Rows	2

### Body Features

Cable Exit Angle	180°
Primary Product Color	Black
Connector & Keying Code	B

### Contact Features

Contact Size	.64mm
--------------	-------



Contact Type	Receptacle
--------------	------------

Mating Tab Width	.64 mm[.025 in]
------------------	-----------------

### Mechanical Attachment

Terminal Position Assurance	Yes
-----------------------------	-----

Strain Relief	Without
---------------	---------

Mating Alignment Type	Keyed
-----------------------	-------

Mating Alignment	With
------------------	------

Connector Mounting Type	Cable Mount (Free-Hanging)
-------------------------	----------------------------

### Housing Features

Housing Material	PA GF
------------------	-------

Centerline (Pitch)	2.54 mm[.1 in]
--------------------	----------------

### Dimensions

Connector Height	23.8 mm[.937 in]
------------------	------------------

Product Width	19.4 mm[.764 in]
---------------	------------------

Product Length	31.4 mm[1.236 in]
----------------	-------------------

Row-to-Row Spacing	5.5 mm[.217 in]
--------------------	-----------------

### Usage Conditions

Operating Temperature (Max)	70 °C, 75 °C, 80 °C, 85 °C, 90 °C, 100 °C, 105 °C, 110 °C, 120 °C, 125 °C[158 °F][167 °F][176 °F][185 °F][194 °F][212 °F][221 °F][230 °F][248 °F][257 °F]
-----------------------------	---

Operating Temperature Range	-40 – 125 °C[-40 – 257 °F]
-----------------------------	----------------------------

### Operation/Application

Circuit Application	Signal
---------------------	--------

### Industry Standards

Degree of Protection	IP67
----------------------	------

### Packaging Features

Packaging Quantity	600
--------------------	-----

Packaging Method	Package
------------------	---------

### Other

Serviceable	Yes
-------------	-----

Connector Position Assurance Capable	No
--------------------------------------	----



## Product Compliance

[For compliance documentation, visit the product page on TE.com>](#)

EU RoHS Directive 2011/65/EU	Compliant
EU ELV Directive 2000/53/EC	Compliant
China RoHS 2 Directive MIIT Order No 32, 2016	No Restricted Materials Above Threshold
EU REACH Regulation (EC) No. 1907/2006	Current ECHA Candidate List: JUNE 2023 (235) Candidate List Declared Against: JUNE 2023 (235) Does not contain REACH SVHC
Halogen Content	Low Halogen - Br, Cl, F, I < 900 ppm per homogenous material. Also BFR/CFR/PVC Free
Solder Process Capability	Not applicable for solder process capability

### Product Compliance Disclaimer

This information is provided based on reasonable inquiry of our suppliers and represents our current actual knowledge based on the information they provided. This information is subject to change. The part numbers that TE has identified as EU RoHS compliant have a maximum concentration of 0.1% by weight in homogenous materials for lead, hexavalent chromium, mercury, PBB, PBDE, DBP, BBP, DEHP, DIBP, and 0.01% for cadmium, or qualify for an exemption to these limits as defined in the Annexes of Directive 2011/65/EU (RoHS2). Finished electrical and electronic equipment products will be CE marked as required by Directive 2011/65/EU. Components may not be CE marked. Additionally, the part numbers that TE has identified as EU ELV compliant have a maximum concentration of 0.1% by weight in homogenous materials for lead, hexavalent chromium, and mercury, and 0.01% for cadmium, or qualify for an exemption to these limits as defined in the Annexes of Directive 2000/53/EC (ELV). Regarding the REACH Regulation, the information TE provides on SVHC in articles for this part number is based on the latest European Chemicals Agency (ECHA) 'Guidance on requirements for substances in articles' posted at this URL: <https://echa.europa.eu/guidance-documents/guidance-on-reach>

## Compatible Parts



Also in the Series | [Get .64 Connector System](#)



Automotive Connector Caps & Covers (3)

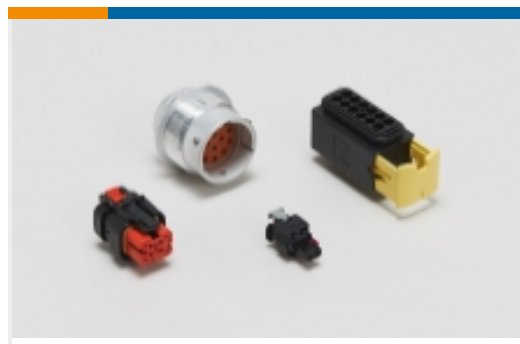

Automotive Housings(88)

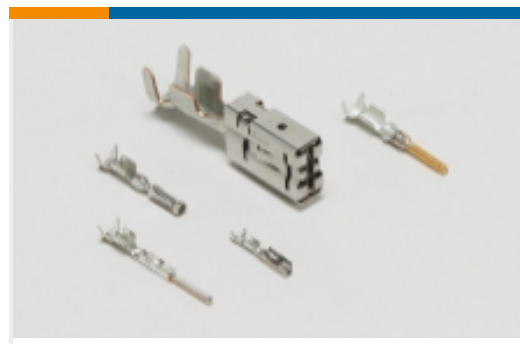

Automotive Terminals(29)

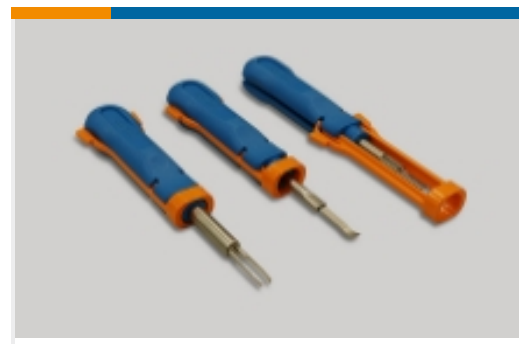

Insertion & Extraction Tools(1)

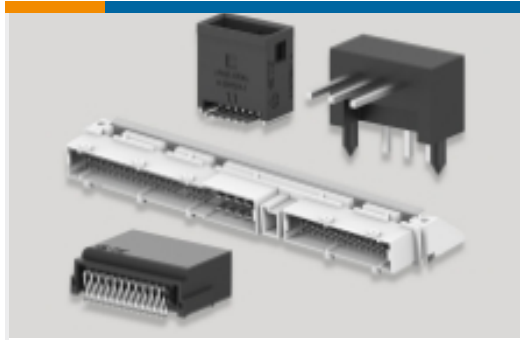

PCB Headers & Receptacles(1)

## Customers Also Bought



TE Part #1393366-1  
GET .64 CONNECTOR SYSTEM,  
RECEPT AND TAB

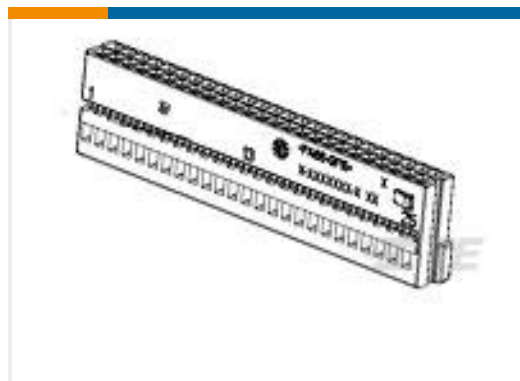

TE Part #1-1703941-1  
50POS MQS REC



TE Part #2035363-5  
1X6 GENERATION Y ASSY KEY D



TE Part #2098660-1  
32P Shield, GY HandMate

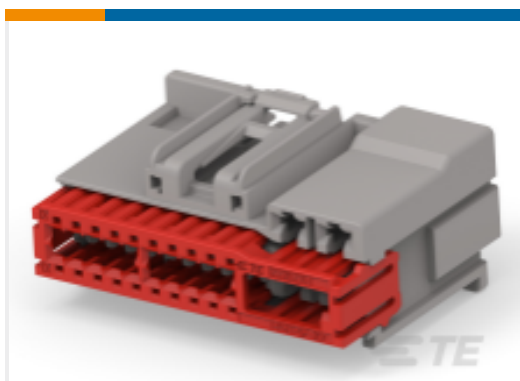

TE Part #1-2236269-1  
24POS, MIXED,REC HSG,  
20GENYMCP,ASSY,CODA



TE Part #1-2236269-2  
24POS, MIXED,REC HSG,  
20GENYMCP,ASSY,CODB



TE Part #2035334-8  
CONTACT, FEMALE0.64 ,20.35SQMM



TE Part #2236269-2  
24POS, MIXED,REC HSG,  
20GENYMCP,ASSY,CODB



TE Part #5-1879524-5  
CRGH2512 1% 392R 2W

## Documents



### Product Drawings

[SEALED HARN ASSY W/O CPA KEY B](#)

English

[SEALED HARN ASSY W/O CPA KEY B](#)

English

---

### CAD Files

Customer View Model

[ENG\\_CVM\\_CVM\\_1411001-1\\_E1.3d\\_stp.zip](#)

English

[3D PDF](#)

3D

Customer View Model

[ENG\\_CVM\\_CVM\\_1411001-1\\_E1.2d\\_dxf.zip](#)

English

Customer View Model

[ENG\\_CVM\\_CVM\\_1411001-1\\_E1.3d\\_igs.zip](#)

English

By downloading the CAD file I accept and agree to the [Terms and Conditions](#) of use.

---

### Datasheets & Catalog Pages

[GET 0.64 Interconnection System](#)

English

---

### Product Specifications

[Application Specification](#)

English

---

### Instruction Sheets

[Instruction Sheet \(U.S.\)](#)

English