

1897210-1 ✓ ACTIVE

AMP MCP Connector System, AMP MCP Hybrids

TE Internal #: 1897210-1

Housing for Female Terminals, Wire-to-Wire, 4 Position, Sealable, Black, Power, Cable Mount (Free-Hanging), Hybrid

[View on TE.com >](#)



Connectors > Automotive Connectors > Automotive Housings > AMP MCP, SEALED CONNECTOR HOUSING

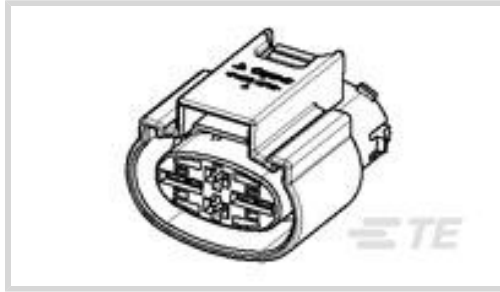

Connector System: **Wire-to-Wire**

Number of Positions: **4**

Connector & Housing Type: **Housing for Female Terminals**

Sealable: **Yes**

Mating Tab Width: **2.8 mm, 6.3 mm [.11 in, .25 in]**

[All AMP MCP, SEALED CONNECTOR HOUSING \(161\)](#)

Features

Product Type Features

Mixed & Hybrid Connector	Yes
Connector Shape	Rectangular
Connector System	Wire-to-Wire
Connector & Housing Type	Housing for Female Terminals
Sealable	Yes
Primary Locking Feature	Integrated in Housing

Configuration Features

Number of Positions	4
---------------------	---

Body Features

Cable Exit Angle	180°
Primary Product Color	Black

Contact Features

Contact Size	2.8K, 6.3mm
Contact Type	Receptacle
Mating Tab Width	2.8 mm, 6.3 mm [.11 in][.25 in]

Mechanical Attachment

Terminal Position Assurance	No
-----------------------------	----



Strain Relief	Without
Mating Alignment Type	Polarized
Mating Alignment	With
Connector Mounting Type	Cable Mount (Free-Hanging)

Housing Features

Housing Material	PA GF
------------------	-------

Dimensions

Connector Height	25.9 mm[1.01 in]
Product Width	33.7 mm[1.32 in]
Product Length	32.2 mm[1.26 in]

Operation/Application

Circuit Application	Power
---------------------	-------

Packaging Features

Packaging Quantity	150
Packaging Method	Bag

Other

Serviceable	No
Connector Position Assurance Capable	No

Product Compliance

[For compliance documentation, visit the product page on TE.com>](#)

EU RoHS Directive 2011/65/EU	Compliant
EU ELV Directive 2000/53/EC	Compliant
China RoHS 2 Directive MIIT Order No 32, 2016	No Restricted Materials Above Threshold
EU REACH Regulation (EC) No. 1907/2006	Current ECHA Candidate List: JUNE 2023 (235) Candidate List Declared Against: JUNE 2023 (235) Does not contain REACH SVHC
Halogen Content	BFR/CFR/PVC Free, but Br/Cl >900 ppm in other sources.
Solder Process Capability	Not applicable for solder process capability

Product Compliance Disclaimer

This information is provided based on reasonable inquiry of our suppliers and represents our current actual knowledge based on the information they provided. This information is subject to change. The part numbers that TE has identified as EU RoHS compliant have a maximum concentration of 0.1% by weight in homogenous materials for lead, hexavalent chromium, mercury, PBB, PBDE, DBP, BBP, DEHP, DIBP, and 0.01% for cadmium, or qualify for an exemption to these limits as defined in the Annexes of Directive 2011/65/EU (RoHS2). Finished electrical and electronic equipment products will be CE marked as required by Directive 2011/65/EU. Components may not be CE marked. Additionally, the part numbers that TE has identified as EU ELV compliant have a maximum concentration of 0.1% by weight in homogenous materials for lead, hexavalent chromium, and mercury, and 0.01% for cadmium, or qualify for an exemption to these limits as defined in the Annexes of Directive 2000/53/EC (ELV). Regarding the REACH Regulation, the information TE provides on SVHC in articles for this part number is based on the latest European Chemicals Agency (ECHA) 'Guidance on requirements for substances in articles' posted at this URL: <https://echa.europa.eu/guidance-documents/guidance-on-reach>

Compatible Parts



TE Part # 1718705-1
SINGLE WIRE SEAL,COLLAR DIA 2,



TE Part # 964972-1
EINZELLEITERDICHTNG



TE Part # 963531-1
BLINDSTOPFEN



TE Part # 963530-1
EINZELLEITERDICHTNG



TE Part # 964971-1
EINZELLEITERDICHTNG



TE Part # 1897209-2
MCP HYB 4P CAP HSG



TE Part # CAT-AM705-T273
AMP MCP, RECEPTACLE AND TAB

Also in the Series | AMP MCP Connector System



Automotive Connector Caps & Covers (22)



Automotive Connector Locks & Position Assurance(6)



Automotive Housings(332)

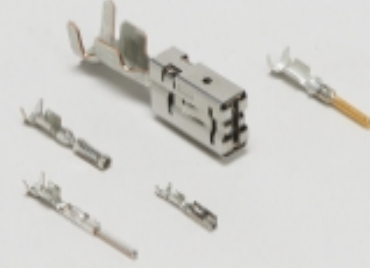

Automotive Terminals(130)

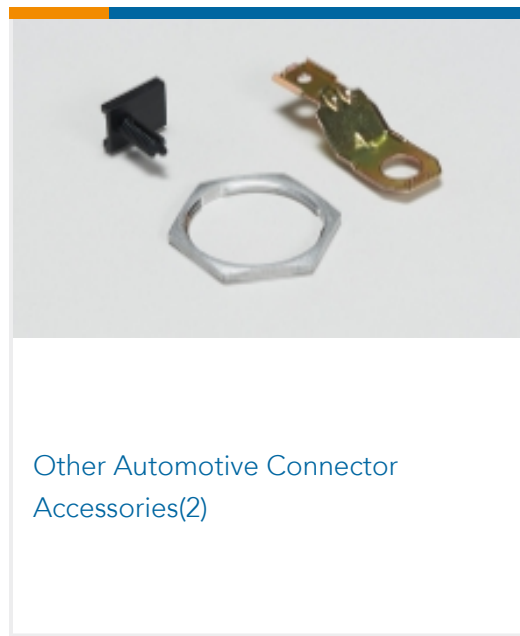
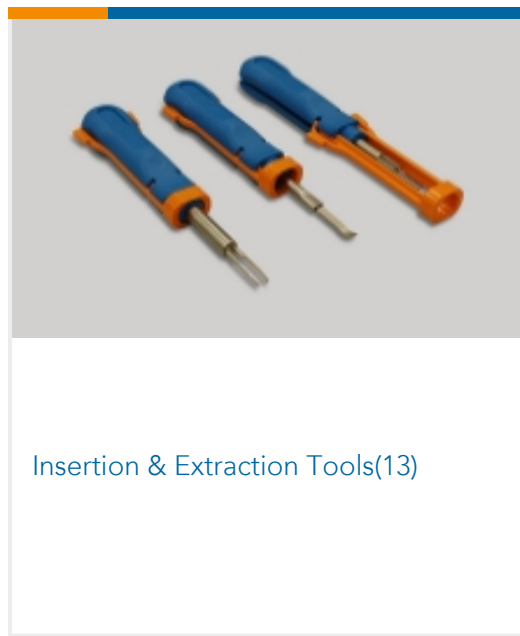
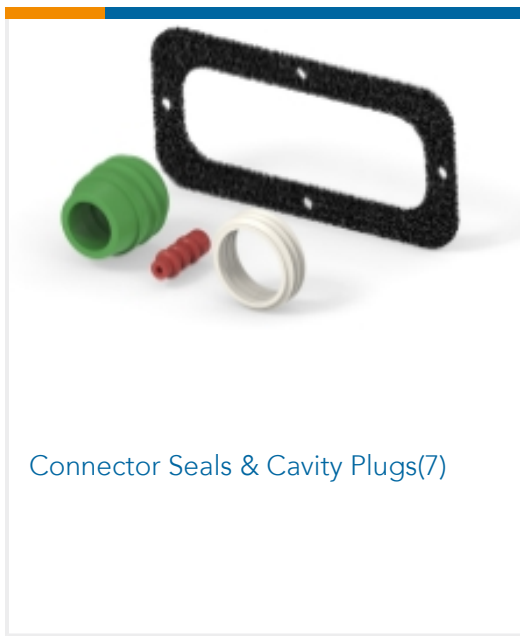

Also in the Series | **AMP MCP Hybrids**

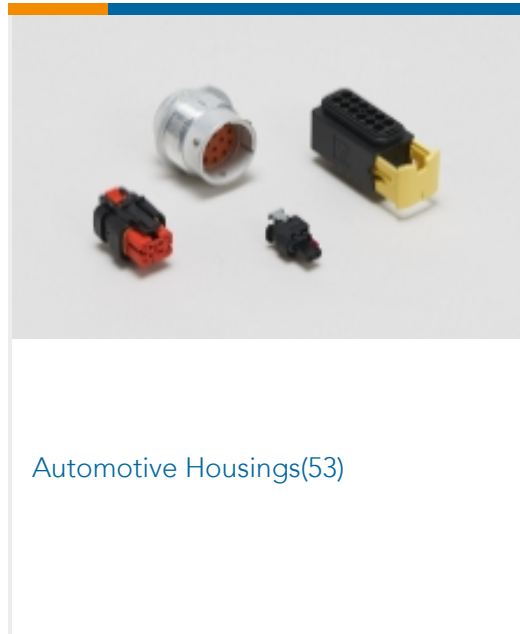
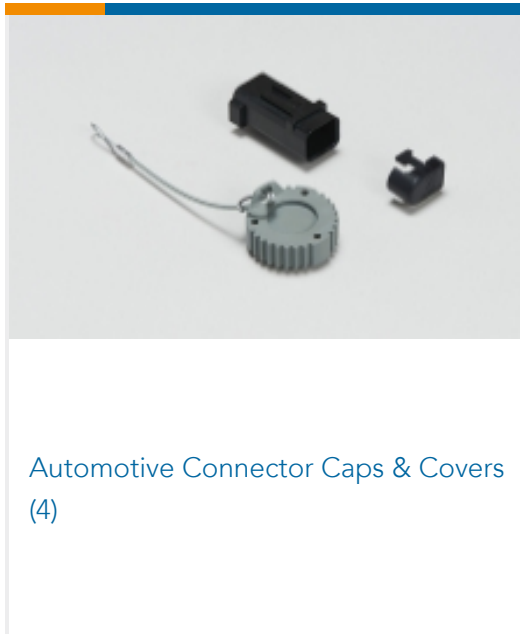

Customers Also Bought





Documents

Product Drawings

[MCP HYB 4P PLUG ASSY](#)

English

CAD Files

[3D PDF](#)

3D

Customer View Model

[ENG_CVM_CVM_1897210-1_A.2d_dxf.zip](#)

English

Customer View Model

[ENG_CVM_CVM_1897210-1_A.3d_igs.zip](#)

English

Customer View Model

[ENG_CVM_CVM_1897210-1_A.3d_stp.zip](#)

English

By downloading the CAD file I accept and agree to the [Terms and Conditions](#) of use.

Product Specifications

[MCP HYB 4P](#)

English