

1-770902-1 ✓ ACTIVE

MATE-N-LOK | Mini-Universal MATE-N-LOK

TE Internal #: 1-770902-1

Socket Contact, Gold, 600 VAC, 600 VDC, 26 – 22 AWG Wire Size, .12 – .4 mm² Wire Size, Crimp, Phosphor Bronze, Power, Mini-Universal MATE-N-LOK

[View on TE.com >](#)



Connectors > Contacts > Connector Contacts



Contact Type: **Socket**

Contact Mating Area Plating Material: **Gold**

Wire Contact Termination Area Plating Material: **Tin**

Operating Voltage: **600 VDC**

Features

Product Type Features

Discrete Wire Type **Stranded**

Electrical Characteristics

Operating Voltage **600 VDC**

Contact Features

Mating Pin Diameter **1 mm[.039 in]**

Contact Underplating Material Thickness **1.27 µm[50 µin]**

Wire Contact Termination Area Plating Thickness **2.54 µm[100 µin]**

Wire Contact Termination Area Plating Material Finish **Bright**

Contact Mating Area Plating Material Thickness **.76 µm[30 µin]**

Contact Orientation **Straight**

Contact Underplating Material **Nickel**

Contact Type **Socket**

Contact Mating Area Plating Material **Gold**

Wire Contact Termination Area Plating Material **Tin**

Contact Retention Within Housing **With**



Contact Base Material	Phosphor Bronze
-----------------------	-----------------

Contact Current Rating (Max)	11.2 A
------------------------------	--------

Termination Features

Termination Method to Wire & Cable	Crimp
------------------------------------	-------

Product Terminates To	Wire & Cable
-----------------------	--------------

Mechanical Attachment

Wire Insulation Support	Without
-------------------------	---------

Dimensions

Compatible Insulation Diameter Range	1.19 – 1.75 mm [.047 – .069 in]
--------------------------------------	---------------------------------

Wire Size	.12 – .4 mm ²
-----------	--------------------------

Usage Conditions

Operating Temperature Range	-55 – 105 °C [-67 – 221 °F]
-----------------------------	-----------------------------

Operation/Application

Circuit Application	Power
---------------------	-------

Industry Standards

Compatible With Agency/Standards Products	CSA, UL
---	---------

UL Flammability Rating	UL 94V-0
------------------------	----------

Packaging Features

Packaging Quantity	7000
--------------------	------

Packaging Method	Reel
------------------	------

Product Compliance

[For compliance documentation, visit the product page on TE.com>](#)

EU RoHS Directive 2011/65/EU	Compliant
------------------------------	-----------

EU ELV Directive 2000/53/EC	Compliant
-----------------------------	-----------

China RoHS 2 Directive MIIT Order No 32, 2016	No Restricted Materials Above Threshold
---	---

EU REACH Regulation (EC) No. 1907/2006	Current ECHA Candidate List: JUNE 2023 (235) Candidate List Declared Against: JUNE 2023 (235) Does not contain REACH SVHC
--	---

Halogen Content	Low Halogen - Br, Cl, F, I < 900 ppm per homogenous material. Also BFR/CFR/PVC Free
-----------------	---

Solder Process Capability

Not applicable for solder process capability

Product Compliance Disclaimer

This information is provided based on reasonable inquiry of our suppliers and represents our current actual knowledge based on the information they provided. This information is subject to change. The part numbers that TE has identified as EU RoHS compliant have a maximum concentration of 0.1% by weight in homogenous materials for lead, hexavalent chromium, mercury, PBB, PBDE, DBP, BBP, DEHP, DIBP, and 0.01% for cadmium, or qualify for an exemption to these limits as defined in the Annexes of Directive 2011/65/EU (RoHS2). Finished electrical and electronic equipment products will be CE marked as required by Directive 2011/65/EU. Components may not be CE marked. Additionally, the part numbers that TE has identified as EU ELV compliant have a maximum concentration of 0.1% by weight in homogenous materials for lead, hexavalent chromium, and mercury, and 0.01% for cadmium, or qualify for an exemption to these limits as defined in the Annexes of Directive 2000/53/EC (ELV). Regarding the REACH Regulation, the information TE provides on SVHC in articles for this part number is based on the latest European Chemicals Agency (ECHA) 'Guidance on requirements for substances in articles' posted at this URL: <https://echa.europa.eu/guidance-documents/guidance-on-reach>

Compatible Parts



TE Part # CAT-AM71-C83998EE
Mini Circular Plastic Connectors (CPC)



TE Part # 91529-1
CCII MINI-UMNL PIN 26-22 ASSY

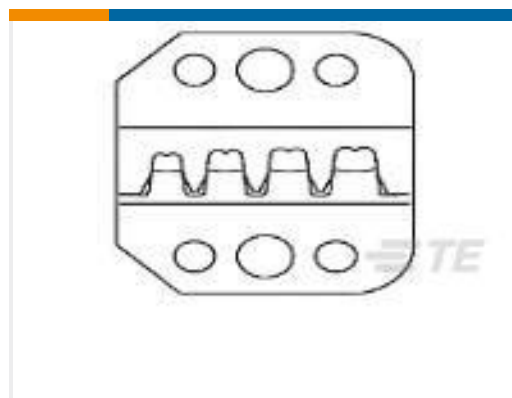

TE Part # 90758-2
PROCRIMP DIE MINI UNIV MNL



TE Part # 770586-1
22P MINI UMNL PLUG HSG



TE Part # 794942-1
10P MINI UMNL CAP HSG



TE Part # 770587-1
24P MINI UMNL PLUG HSG



TE Part # 770582-1
14P MINI UMNL PLUG HSG



TE Part # 770585-1
20P MINI UMNL PLUG HSG



TE Part # 172333-1
MINI UNIVERSAL M-N-L HOUSING



TE Part # 794781-1
10P MINI UMNL PLUG HSG



TE Part # 794941-1
08P MINI UMNL CAP HSG



TE Part # 794895-1
6 CIR MINI UMNL RND WIRE HOLES



TE Part # 794821-1
08P MINI UMNL PLUG HSG



TE Part # 794940-1
06P MINI UMNL CAP HSG



TE Part # 770581-1
12P MINI UMNL PLUG HSG



TE Part # 770580-1
10P MINI UMNL PLUG HSG



TE Part # 770584-1
18P MINI UMNL PLUG HSG



TE Part # 172328-1
MINI UNIVERSAL MATE-N-LOK CAP HOUSING 2P



TE Part # 172330-1
MINI UNIVERSAL MATE-N-LOK CAP HOUSING 4P



TE Part # 172344-1
MINI UNIVERSAL MATE-N-LOK CAP HOUSING 3P

Also in the Series | Mini-Universal MATE-N-LOK

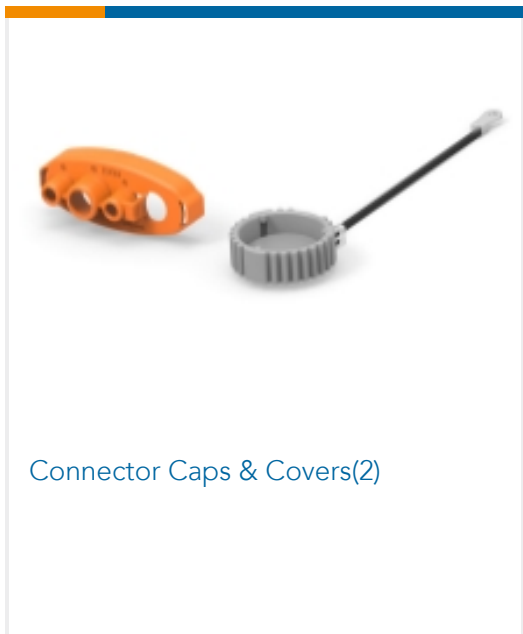

Connector Caps & Covers(2)

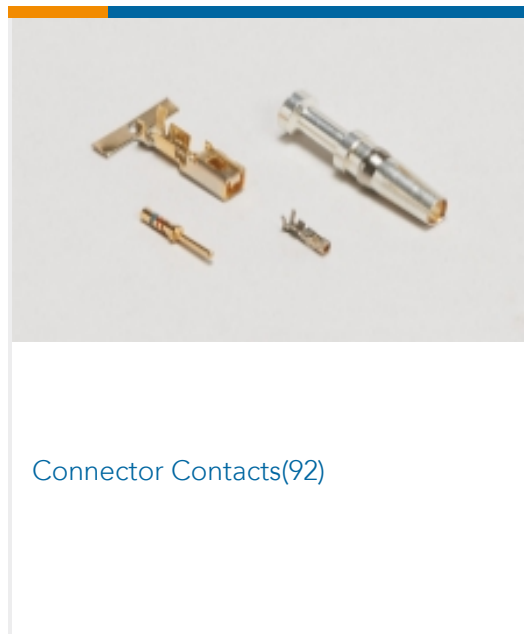

Connector Contacts(92)



Connector Hardware(4)

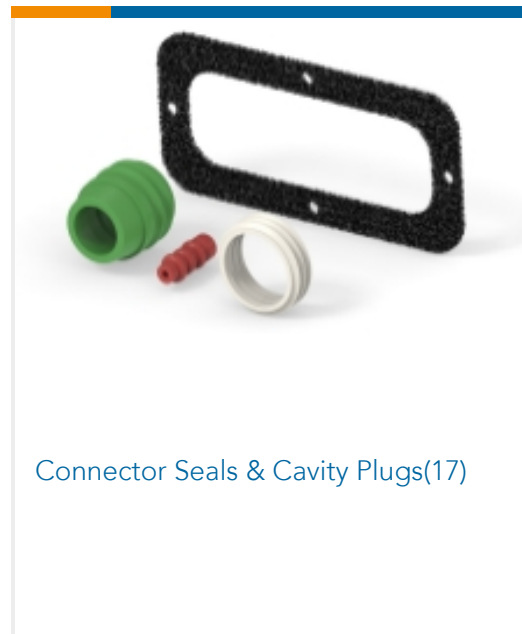

Connector Seals & Cavity Plugs(17)

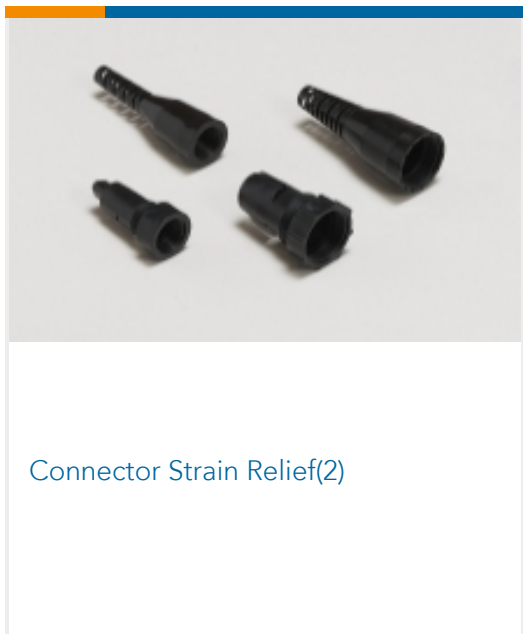

Connector Strain Relief(2)

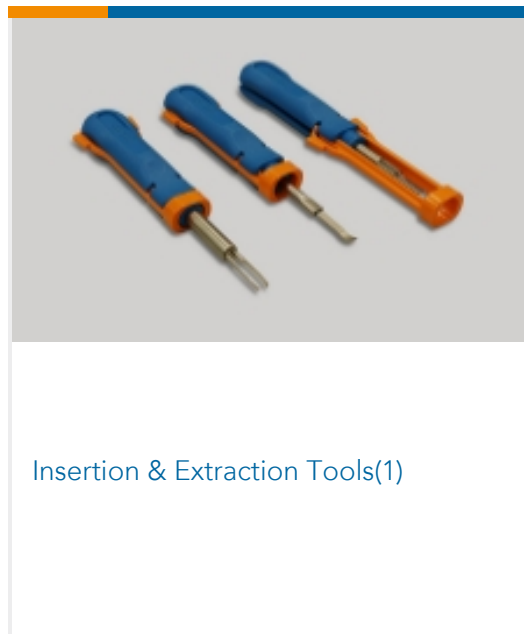

Insertion & Extraction Tools(1)



PCB Headers & Receptacles(1)



Rectangular Power Connectors(197)

Customers Also Bought



TE Part #1-1375820-6
CST-100 II HOUSING 16 POS



TE Part #207604-1
METRIMATE,STR REL KIT,36P



TE Part #52454
PG SPR SPD 22-16COMM 22-18MIL8



TE Part #5-104549-1
10 SYS50 S/M HDR DRST SHRDSN

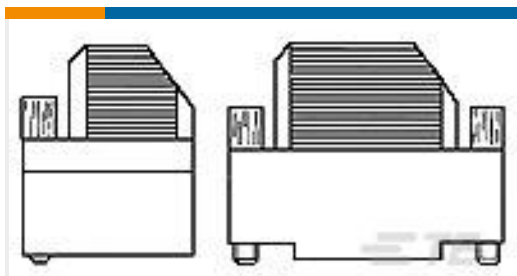

TE Part #5-1393738-9
V42254A6004G109=SUB D GEHAEUSE



TE Part #5-104069-4
10 sys 50 hdr drra shrd sn



TE Part #T2080062101-100
HQ-4/2-M



TE Part #NB09206001
ATUM-12/4-0-50MM

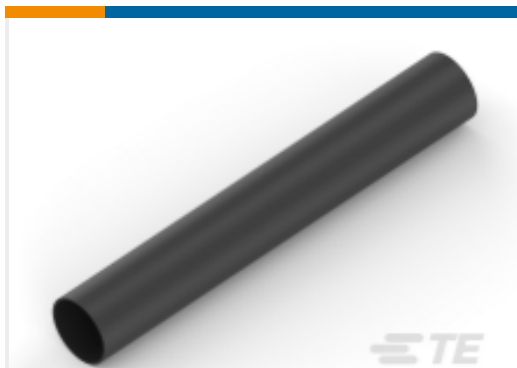

TE Part #NB09436001
ATUM-16/4-0-50MM



TE Part #364215-E
SRCBUG A 2,54 2 3 CSI 165 E1 ADV J
2 324

Documents

Product Drawings

MINI UMNL SOK 26-22 AWG AU LF

English

CAD Files

Customer View Model

[ENG_CVM_CVM_1-770902-1_T.2d_dxf.zip](#)

English

3D PDF

3D

Customer View Model

[ENG_CVM_CVM_1-770902-1_T.3d_igs.zip](#)

English

Customer View Model

[ENG_CVM_CVM_1-770902-1_T.3d_stp.zip](#)

English

By downloading the CAD file I accept and agree to the [Terms and Conditions](#) of use.

Datasheets & Catalog Pages

AMP Circular Connectors for Commercial Signal & Power Applications Continued

English

SOFT_SHELL_PIN_AND_SOCKET_CONNECTORS_CATALOG

English

Product Specifications

Application Specification

English



[Instruction Sheets](#)

[Instruction Sheet \(U.S.\)](#)

English