

### Features

- Surge overload ratings to 30 amperes peak.
- 1.0A rating in low profile surface mount mini-dip bridge save space on printed circuit board.
- Ideal for automated replacement.
- Reliable low cost construction utilizing molded plastic technology results in inexpensive product.
- Silicon eplana epitaxial chip, metal silicon junction.
- Lead-free parts meet RoHS requirements.

### Mechanical data

- Epoxy:UL94-V0 rated flame retardant
- Case : Molded plastic, MBF
- Terminals : Solder plated, solderable per MIL-STD-750, Method 2026
- Polarity : marked on body
- Mounting Position : Any

### Package outline

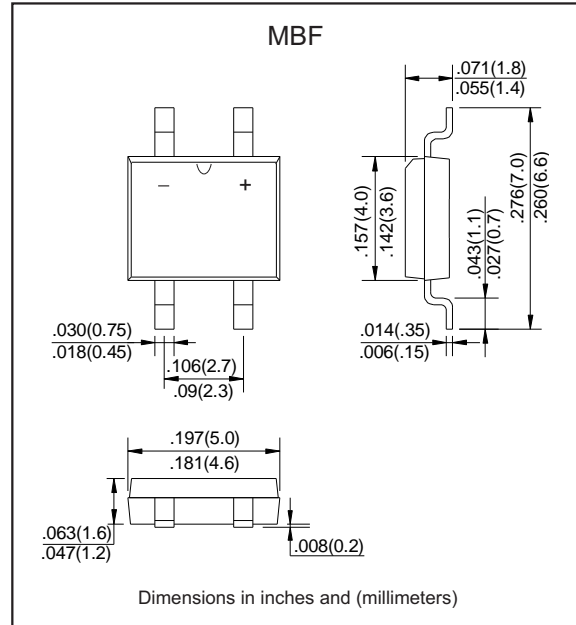

### Maximum ratings and Electrical Characteristics (AT $T_A=25^\circ\text{C}$ unless otherwise noted)

PARAMETER	SYMBOLS	KMB12F	KMB14F	KMB16F	KMB110F	KMB115F	KMB120F	UNITS
Maximum repetitive peak reverse voltage	$V_{RRM}$	20	40	60	100	150	200	V
Maximum RMS voltage	$V_{RMS}$	14	28	42	70	105	140	V
Maximum DC blocking voltage	$V_{DC}$	20	40	60	100	150	200	V
Maximum average forward rectified current at $T_L$ (see fig.1)	$I_{(AV)}$	1.0						A
Peak forward surge current 8.3ms single half sine-wave superimposed on rated load	$I_{FSM}$	30.0						A
Maximum instantaneous forward voltage at 1.0A	$V_F$	0.55		0.70	0.85	0.92		V
Maximum DC reverse current $T_J=25^\circ\text{C}$ at rated DC blocking voltage $T_J=100^\circ\text{C}$	$I_R$	0.2 10.0						mA
Typical junction capacitance (NOTE 1)	$C_J$	28						pF
Typical thermal resistance (NOTE 2)	$R_{\theta JA}$	75						$^\circ\text{C}/\text{W}$
Operating junction temperature range	$T_J$	-55 to +125		-55 to +150				$^\circ\text{C}$
Storage temperature range	$T_{STG}$	-55 to +150						$^\circ\text{C}$

Note:1.Measured at 1.0MHz and applied reverse voltage of 4.0V DC

2.Thermal resistance from junction to ambient mounted on P.C.B with 0.5\*0.5"(13\*13mm)copper pads.

Rating and characteristic curves

FIG. 1- FORWARD CURRENT DERATING CURVE

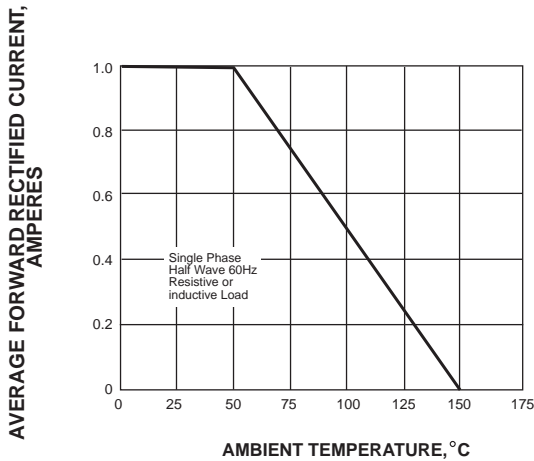

FIG. 2-MAXIMUM NON-REPETITIVE PEAK FORWARD SURGE CURRENT

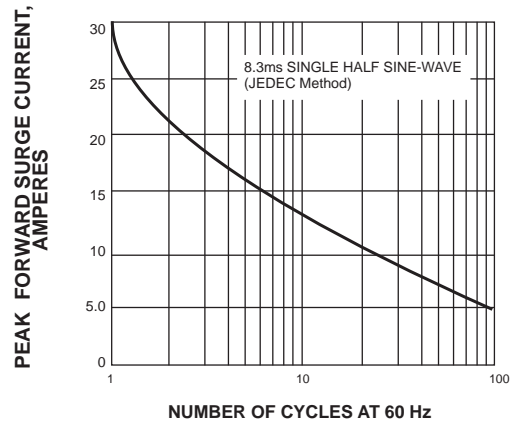

FIG. 3-TYPICAL INSTANTANEOUS FORWARD CHARACTERISTICS

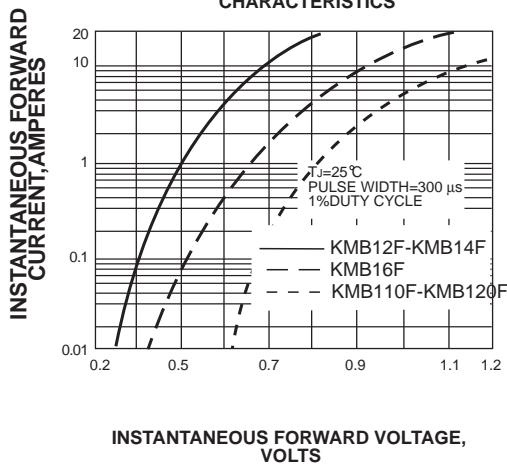

FIG. 4-TYPICAL REVERSE CHARACTERISTICS

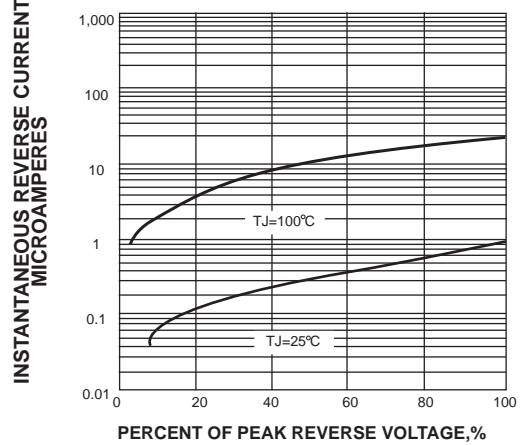
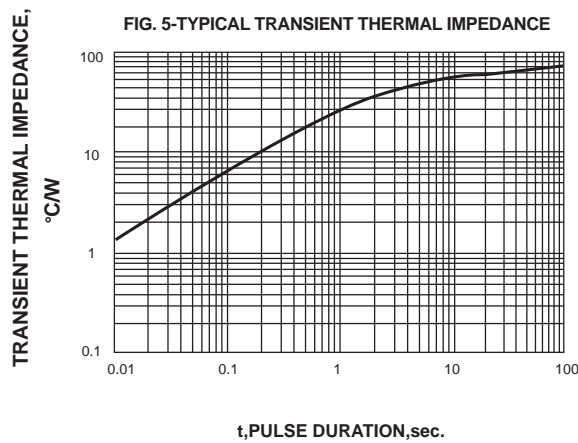

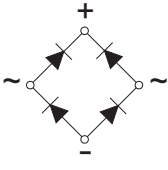

FIG. 5-TYPICAL TRANSIENT THERMAL IMPEDANCE



## Pinning information

Simplified outline	Symbol
	

## Marking

Type number	Marking code
KMB12F	KMB12F
KMB14F	KMB14F
KMB16F	KMB16F
KMB110F	KMB110F
KMB115F	KMB115F
KMB120F	KMB120F

## Suggested solder pad layout

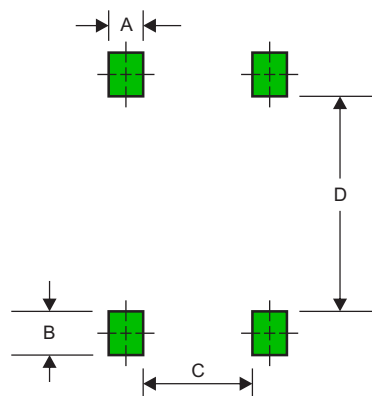

Dimensions in inches and (millimeters)

PACKAGE	A	B	C	D
MBF	0.023 (0.58)	0.030 (0.76)	0.070 (1.78)	0.226 (5.75)

**Suggested thermal profiles for soldering processes**

- 1.Storage environment: Temperature=5°C~40°C Humidity=55%±25%
- 2.Reflow soldering of surface-mount devices



3.Reflow soldering

Profile Feature	Soldering Condition
Average ramp-up rate(TL to TP)	<3°C/sec
Preheat -Temperature Min(Tsmin) -Temperature Max(Tsmax) -Time(min to max)(ts)	150°C 200°C 60~120sec
Tsmax to TL -Ramp-upRate	<3°C/sec
Time maintained above: -Temperature(TL) -Time(tL)	217°C 60~260sec
Peak Temperature(TP)	255°C-0/+5°C
Time within 5°C of actual Peak Temperature(tp)	10~30sec
Ramp-down Rate	<6°C/sec
Time 25°C to Peak Temperature	<6minutes