

5-968972-1 ✓ ACTIVE

AMP | AMP MCP 2.8, AMP MCP Connector System

TE Internal #: 5-968972-1

Housing for Female Terminals, Wire-to-Wire, 12 Position, .197 in [5 mm] Centerline, Signal, Cable Mount (Free-Hanging), Hybrid

[View on TE.com >](#)



Connectors > Automotive Connectors > Automotive Housings > AMP MCP Unsealed Connector Housings



Connector System: **Wire-to-Wire**

Number of Positions: **12**

Connector & Housing Type: **Housing for Female Terminals**

Centerline (Pitch): **5 mm [.197 in]**

Sealable: **No**

[All AMP MCP Unsealed Connector Housings \(191\)](#)

Features

Product Type Features

Mixed & Hybrid Connector	No
Connector Shape	Rectangular
Connector System	Wire-to-Wire
Connector & Housing Type	Housing for Female Terminals
Sealable	No
Primary Locking Feature	On the Terminal

Configuration Features

Number of Positions	12
Number of Rows	3

Electrical Characteristics

Operating Voltage	28 VDC
Nominal Voltage Architecture	12 V, 24 V

Body Features



Cable Exit Angle	180°
Connector & Keying Code	D

Contact Features

Contact Size	2.8mm
Contact Type	Receptacle
Mating Tab Width	2.8 mm[.11 in]

Mechanical Attachment

Terminal Position Assurance	Yes
Strain Relief	Without
Mating Alignment Type	Keyed
Mating Alignment	With
Connector Mounting Type	Cable Mount (Free-Hanging)

Housing Features

Housing Material	PBT GF
Centerline (Pitch)	5 mm[.197 in]

Dimensions

Connector Height	24 mm[.945 in]
Product Width	26 mm[1.024 in]
Product Length	26 mm[1.024 in]

Usage Conditions

Operating Temperature (Max)	70 °C, 75 °C, 80 °C, 85 °C, 90 °C, 100 °C, 105 °C, 110 °C, 120 °C[158 °F][167 °F][176 °F][185 °F][194 °F][212 °F][221 °F][230 °F][248 °F]
Operating Temperature Range	-40 – 120 °C[-40 – 248 °F]

Operation/Application

Circuit Application	Signal
---------------------	--------

Packaging Features

Packaging Quantity	1500
Packaging Method	Box

Other

Serviceable	No
Connector Position Assurance Capable	No



Product Compliance





[For compliance documentation, visit the product page on TE.com>](#)

EU RoHS Directive 2011/65/EU	Compliant
EU ELV Directive 2000/53/EC	Compliant
China RoHS 2 Directive MIIT Order No 32, 2016	No Restricted Materials Above Threshold
EU REACH Regulation (EC) No. 1907/2006	Current ECHA Candidate List: JUNE 2023 (235) Candidate List Declared Against: JUNE 2023 (235) Does not contain REACH SVHC
Halogen Content	BFR/CFR/PVC Free, but Br/Cl >900 ppm in other sources.
Solder Process Capability	Not applicable for solder process capability

Product Compliance Disclaimer

This information is provided based on reasonable inquiry of our suppliers and represents our current actual knowledge based on the information they provided. This information is subject to change. The part numbers that TE has identified as EU RoHS compliant have a maximum concentration of 0.1% by weight in homogenous materials for lead, hexavalent chromium, mercury, PBB, PBDE, DBP, BBP, DEHP, DIBP, and 0.01% for cadmium, or qualify for an exemption to these limits as defined in the Annexes of Directive 2011/65/EU (RoHS2). Finished electrical and electronic equipment products will be CE marked as required by Directive 2011/65/EU. Components may not be CE marked. Additionally, the part numbers that TE has identified as EU ELV compliant have a maximum concentration of 0.1% by weight in homogenous materials for lead, hexavalent chromium, and mercury, and 0.01% for cadmium, or qualify for an exemption to these limits as defined in the Annexes of Directive 2000/53/EC (ELV). Regarding the REACH Regulation, the information TE provides on SVHC in articles for this part number is based on the latest European Chemicals Agency (ECHA) 'Guidance on requirements for substances in articles' posted at this URL: <https://echa.europa.eu/guidance-documents/guidance-on-reach>

Compatible Parts

 <p>TE Part # 9-966140-3 MESSERLEISTE 12P</p>	 <p>TE Part # 4-967627-1 TAB HSG 2.8MM 12POS.</p>	 <p>TE Part # CAT-AM705-T273 AMP MCP, RECEPTACLE AND TAB</p>	 <p>TE Part # 4-966140-6 TAB HEADER2,8X0,8MM 21POS</p>
--	---	---	---

Also in the Series | [AMP MCP 2.8](#)



Automotive Connector Caps & Covers (1)



Automotive Connector Locks & Position Assurance(5)



Automotive Housings(167)



Automotive Terminals(9)



Connector Seals & Cavity Plugs(1)



Insertion & Extraction Tools(6)



Module Components(1)

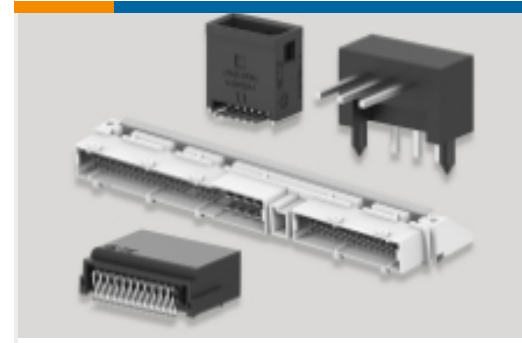

PCB Headers & Receptacles(1)

Also in the Series | AMP MCP Connector System



Automotive Connector Caps & Covers (22)

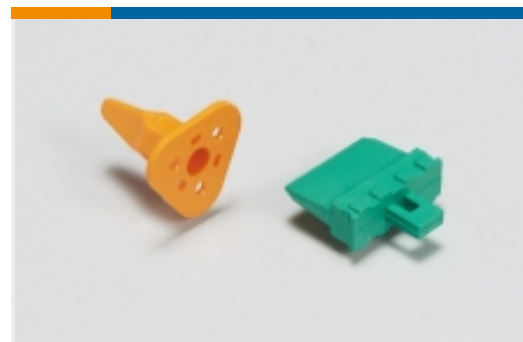

Automotive Connector Locks & Position Assurance(6)



Automotive Housings(332)



Automotive Terminals(130)



Connector Seals & Cavity Plugs(7)



Insertion & Extraction Tools(13)



Other Automotive Connector Accessories(2)

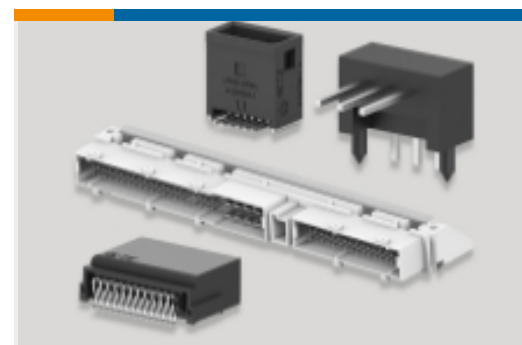

PCB Headers & Receptacles(28)

Customers Also Bought

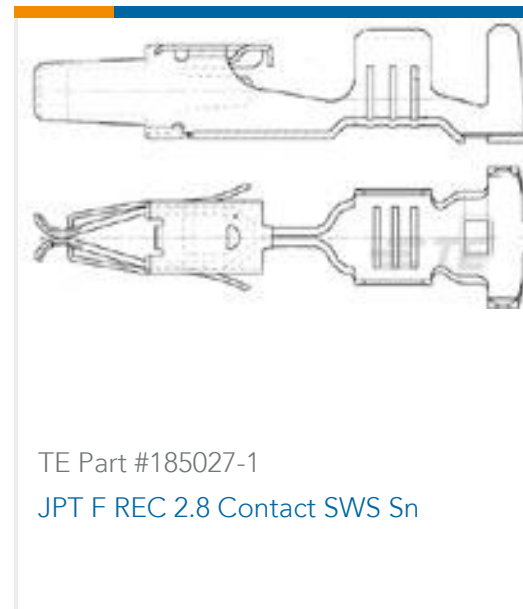

Documents

Product Drawings

[AMP MCP 2.8 HSG 12POS. 2.LOCKING](#)

English

CAD Files

[3D PDF](#)

3D

Customer View Model

[ENG_CVM_CVM_5-968972-1_F.2d_dxf.zip](#)

English

Customer View Model

[ENG_CVM_CVM_5-968972-1_F.3d_igs.zip](#)

English

Customer View Model

[ENG_CVM_CVM_5-968972-1_F.3d_stp.zip](#)

English

By downloading the CAD file I accept and agree to the [Terms and Conditions](#) of use.

Product Specifications

[Application Specification](#)

English